



# TC8000



## Touch Computer

---

## User Guide for Android™ Version 5.1.1





# **TC8000 USER GUIDE**

MN-002898-04

Rev. A

December 2017

No part of this publication may be reproduced or used in any form, or by any electrical or mechanical means, without permission in writing. This includes electronic or mechanical means, such as photocopying, recording, or information storage and retrieval systems. The material in this manual is subject to change without notice.

The software is provided strictly on an “as is” basis. All software, including firmware, furnished to the user is on a licensed basis. We grant to the user a non-transferable and non-exclusive license to use each software or firmware program delivered hereunder (licensed program). Except as noted below, such license may not be assigned, sublicensed, or otherwise transferred by the user without prior written consent. No right to copy a licensed program in whole or in part is granted, except as permitted under copyright law. The user shall not modify, merge, or incorporate any form or portion of a licensed program with other program material, create a derivative work from a licensed program, or use a licensed program in a network without written permission. The user agrees to maintain copyright notice on the licensed programs delivered hereunder, and to include the same on any authorized copies it makes, in whole or in part. The user agrees not to decompile, disassemble, decode, or reverse engineer any licensed program delivered to the user or any portion thereof.

We reserve the right to make changes to any software or product to improve reliability, function, or design.

We do not assume any product liability arising out of, or in connection with, the application or use of any product, circuit, or application described herein.

No license is granted, either expressly or by implication, estoppel, or otherwise under any of our intellectual property rights. An implied license only exists for equipment, circuits, and subsystems contained in our products.

---

## Revision History

Changes to the original manual are listed below:

Change	Date	Description
01 Rev. A	12/2016	Initial release.
02 Rev. A	02/2017	Updated.
03 Rev. A	6/2017	In Specifications, add SD card format.
04 Rev A	12/2017	In Specifications, updates to decode zone for SE4850.



# TABLE OF CONTENTS

Revision History .....	iii
------------------------	-----

## About This Guide

Introduction .....	xi
Documentation Set .....	xi
Chapter Descriptions .....	xiv
Related Documents and Software .....	xv
Service Information .....	xvi
Provide Documentation Feedback .....	xvi

## Chapter 1: Getting Started

Introduction .....	1-1
Unpacking .....	1-1
Removing the Screen Protection Film .....	1-1
Features .....	1-2
Front View Descriptions .....	1-3
Back View Descriptions .....	1-5
Setup .....	1-5
Installing the microSD Card .....	1-5
Installing the Battery .....	1-8
Charging the Battery .....	1-9
Starting the TC8000 .....	1-10
Google™ Account Setup .....	1-11
Installing the Hand Strap .....	1-11
Hot Swap Mode .....	1-13
Replacing the Battery .....	1-14
Battery Management .....	1-15
Monitor Battery Usage .....	1-15
Low Battery Notification .....	1-16
Battery Optimization .....	1-17
Turning Off the Radios .....	1-17
Setting the Date and Time .....	1-17

Display Setting .....	1-17
Setting the Screen Brightness .....	1-18
Setting Screen Timeout Setting .....	1-18
Setting Font Size .....	1-18
Setting Screen Rotation .....	1-19
Touch Mode .....	1-19
General Sound Setting .....	1-20
Zebra Volume Control .....	1-22
Wake-Up Sources .....	1-25

## Chapter 2: Using the TC8000

Introduction .....	2-1
Google Mobile Services .....	2-1
Home Screen .....	2-2
Status Bar .....	2-3
Status Icons .....	2-3
Notification Icons .....	2-4
Managing Notifications .....	2-6
Quick Settings .....	2-6
Application Shortcuts and Widgets .....	2-7
Adding an Application or Widget to the Home Screen .....	2-7
Moving Items on the Home Screen .....	2-8
Removing an App or Widget from the Home Screen .....	2-8
Folders .....	2-8
Creating a Folder .....	2-8
Naming Folders .....	2-8
Removing a Folder .....	2-8
Home Screen Wallpaper .....	2-8
Changing the Home Screen Wallpaper .....	2-8
Using the Touchscreen .....	2-9
Using the On-screen Keyboard .....	2-9
Editing Text .....	2-9
Entering Numbers, Symbols and Special Characters .....	2-10
Applications .....	2-10
Accessing Applications .....	2-14
Switching Between Recent Applications .....	2-14
Un-Locking the Screen .....	2-15
Single User Mode .....	2-15
MultiUser Mode .....	2-17
MultiUser Login .....	2-17
MultiUser Logout .....	2-18
Suspend Mode .....	2-18
Interactive Sensor Technology .....	2-19
Resetting the TC8000 .....	2-19
Performing a Soft Reset .....	2-19
Performing a Hard Reset .....	2-19



**Chapter 3: Data Capture**

Introduction .....	3-1
Status LED .....	3-1
Laser Scanning .....	3-2
Imaging .....	3-2
Operational Modes .....	3-2
Digital Camera .....	3-3
Scanning Considerations .....	3-3
Bar Code Capture with Laser Scanner .....	3-3
Bar Code Capture with Imager .....	3-4
Bar Code Capture with Camera .....	3-6
Bar Code Capture with RS507 Hands-Free Imager .....	3-7
Pairing the RS507 Hands-Free Imager Using SSI .....	3-9
Pairing the RS507 Hands-Free Imager Using Bluetooth HID .....	3-9
Hands Free Scanning .....	3-11
Settings .....	3-12
Scanning Mode .....	3-13
Proximity Range .....	3-13
Ergonomic Recommendations .....	3-14
Proper Scanning .....	3-14
Avoid .....	3-14
DataWedge .....	3-15
Enable DataWedge .....	3-15
Disable DataWedge .....	3-15

**Chapter 4: Wireless**

Wireless Local Area Networks .....	4-1
Scan and Connect to a Wi-Fi Network .....	4-2
Configuring a Wi-Fi Network .....	4-3
Manually Adding a Wi-Fi Network .....	4-5
Configuring for a Proxy Server .....	4-6
Configuring the Device to Use a Static IP Address .....	4-7
Advanced Wi-Fi Settings .....	4-8
Wi-Fi Direct .....	4-8
WPS Pin Entry .....	4-9
Additional Wi-Fi Settings .....	4-10
Additional Wi-Fi Advanced Features .....	4-11
Zebra Mobility Extensions .....	4-12
Remove a Wi-Fi Network .....	4-12
Bluetooth .....	4-13
Adaptive Frequency Hopping .....	4-13
Security .....	4-13
Bluetooth Profiles .....	4-14
Bluetooth Power States .....	4-14
Bluetooth Radio Power .....	4-15
Enabling Bluetooth .....	4-15
Disabling Bluetooth .....	4-15
Discovering Bluetooth Device(s) .....	4-15
Changing the Bluetooth Name .....	4-16

Connecting to a Bluetooth Device .....	4-16
Selecting Profiles on the Bluetooth Device .....	4-16
Unpairing a Bluetooth Device .....	4-17
Near Field Communications .....	4-17
Reading NFC Cards .....	4-18
Sharing Information Using NFC .....	4-18
Enterprise NFC Settings .....	4-19
Reader Mode .....	4-21

## Chapter 5: Applications

Introduction .....	5-1
Camera .....	5-2
Taking Photos .....	5-2
Taking a Panoramic Photo .....	5-4
Recording Videos .....	5-4
Photo Settings .....	5-6
Video Settings .....	5-7
Contacts .....	5-8
Adding Contacts .....	5-8
Editing Contacts .....	5-8
Deleting Contacts .....	5-8
DataWedge Demonstration .....	5-9
Elemesz .....	5-10
Disabling Elemesz Data Collection .....	5-10
Enabling Elemesz Data Collection .....	5-11
File Browser .....	5-12
Gallery .....	5-14
Working with Albums .....	5-14
Share an Album .....	5-15
Get Album Information .....	5-15
Deleting an Album .....	5-15
Working with Photos .....	5-16
Viewing and Browsing Photos .....	5-16
Cropping a Photo .....	5-16
Setting a Photo as a Contact Icon .....	5-17
Share a Photo .....	5-17
Deleting a Photo .....	5-17
Working with Videos .....	5-18
Watching Videos .....	5-18
Sharing a Video .....	5-18
Deleting a Video .....	5-19
MLog Manager .....	5-20
Print Station .....	5-21
PTT Express Voice Client .....	5-22
PTT Audible Indicators .....	5-22
Notification Icons .....	5-23
Enabling PTT Communication .....	5-24
Selecting a Talk Group .....	5-24
PTT Communication .....	5-24

Creating a Group Call .....	5-25
Disabling PTT Express Voice Client Communication .....	5-25
RxLogger .....	5-26
RxLogger Configuration .....	5-26
Configuration File .....	5-26
Enabling Logging .....	5-26
Disabling Logging .....	5-27
Extracting Log Files .....	5-27
Tap & Pair .....	5-28
Zebra Utilities .....	5-30

## Chapter 6: Accessories

Accessories .....	6-1
2-Slot Charge Only Cradle .....	6-4
Charging the Device .....	6-4
Charging the Spare Battery .....	6-5
Battery Charging .....	6-5
Main Battery Charging .....	6-5
Spare Battery Charging .....	6-5
Charging Temperature .....	6-6
5-Slot Charge Only Cradle .....	6-7
Charging the TC8000 .....	6-7
Battery Charging .....	6-8
Main Battery Charging .....	6-8
Charging Temperature .....	6-8
5-Slot Charge Only Cradle with Battery Charger .....	6-9
Charging the Device .....	6-9
Charging the Spare Battery .....	6-10
Battery Charging .....	6-10
Main Battery Charging .....	6-10
Spare Battery Charging .....	6-10
Charging Temperature .....	6-11
5-Slot Ethernet Cradle .....	6-12
Charging the TC8000 .....	6-12
Battery Charging .....	6-13
Main Battery Charging .....	6-13
Charging Temperature .....	6-13
Establishing Ethernet Communication .....	6-13
Ethernet LED Indicators .....	6-14
5-Slot Ethernet Cradle with Battery Charger .....	6-15
Charging the TC8000 .....	6-15
Charging the Spare Battery .....	6-16
Battery Charging .....	6-16
Main Battery Charging .....	6-16
Spare Battery Charging .....	6-16
Charging Temperature .....	6-17
Establishing Ethernet Communication .....	6-17
Ethernet LED Indicators .....	6-17
4-Slot Battery Charger .....	6-18

Battery Installation .....	6-18
Battery Removal .....	6-19
Battery Charging .....	6-19
Spare Battery Charging .....	6-19
Charging Temperature .....	6-19
USB and Charging Cable .....	6-20
Attaching the USB and Charging Cable .....	6-20
Removing the USB and Charging Cable .....	6-21
Battery Charging .....	6-21
Main Battery Charging .....	6-21
Charging Temperature .....	6-21
Quick Disconnect Audio Adapter .....	6-22
Attaching the Audio Adapter .....	6-22
Connecting the Adapter to a Headset .....	6-22
Removing the Audio Adapter .....	6-23
3.5 mm Audio Adapter .....	6-24
Attaching the Audio Adapter .....	6-24
Connecting the Adapter to a Headset .....	6-24
Headset Recommendations .....	6-25
Removing the Audio Adapter .....	6-25
Pairing the HS3100 Bluetooth Headset to the TC8000 .....	6-26
Pairing Using Near Field Communication .....	6-26
Desktop Stand .....	6-27
Cart Mount .....	6-28
Quick-Draw Soft Holster .....	6-29
Presentation Holster .....	6-30
Stylus .....	6-31

**Chapter 7: Maintenance and Troubleshooting**

Introduction .....	7-1
Maintaining the TC8000 .....	7-1
Battery Safety Guidelines .....	7-1
Long Term Storage .....	7-2
Cleaning .....	7-2
Materials Required .....	7-2
Cleaning the TC8000 .....	7-3
Housing .....	7-3
Display .....	7-3
Scan Exit Window .....	7-3
Power Connector .....	7-3
Cleaning Cradle Connectors .....	7-3
Cleaning Frequency .....	7-4
Troubleshooting .....	7-5
TC8000 .....	7-5

**Appendix A: Specifications**

Technical Specifications .....	A-1
SE965 Standard Range Laser Decode Zones .....	A-4

SE4750-SR Decode Distances ..... A-5  
SE4750-MR Decode Zones ..... A-6  
SE4850 Decode Zones ..... A-7

**Index**



# ABOUT THIS GUIDE

---

## Introduction

This guide provides information about setting up and configuring TC8000 mobile computers with Android operating system and installing its accessories.



**NOTE** Some screens or windows shown in this guide may differ from the actual screens shown on the TC8000.

---

## Documentation Set

The documentation set for the TC8000 is divided into guides that provide information for specific user needs.

TC8000 documentation includes:

- **TC8000 Quick Reference Guide** - describes basic set up and operation of the TC8000 and its accessories.
- **TC8000 User Guide** (this guide) - describes how to set up, operate and program the TC8000 with Android operating system and its accessories.
- **TC8000 Integrator Guide** - describes how to setup and configure TC8000 and accessories.








Configuration	Radios			Data Capture					Display	Memory			OS	Sensors					
	802.11 abgn	Bluetooth 4.0	NFC	SE965 Laser Engine	SE4750-SR Imager	SE4750-MR Imager	SE4850 Imager	8 MP Camera	4" WVGA Color	1G RAM/4 GB Flash	1G RAM/8 GB Flash	2G RAM/16 GB Flash	Android AOSP/GMS V5.1.1	Accelerometer	Proximity Sensor	Gyroscope	Digital Compass	Ambient Light	Condensation Resistant
TC80NH-3102K420NA	X	X	X				X	X	X			X	X	X	X	X	X	X	
TC80NH-1102K420IN	X	X	X		X			X	X			X	X	X	X	X	X	X	
TC80NH-3102K420IN	X	X	X				X	X	X			X	X	X	X	X	X	X	
<b>Premium + Expansion</b>																			
TC80NH-2101K42ENA	X	X	X			X		X	X		X		X	X	X	X	X	X	
TC80NH-2101K42EIN	X	X	X			X		X	X		X		X	X	X	X	X	X	
TC80NH-1101K42ENA	X	X	X		X			X	X		X		X	X	X	X	X	X	
TC80NH-1101K42EIN	X	X	X		X			X	X		X		X	X	X	X	X	X	

---

## Software Versions

To determine the current software versions, touch  >  >  **About device**.

- Model number - Displays the model number.
- Android version - Displays the operating system version.
- Kernel version - Displays the kernel version number.
- Build number - Displays the software build number.

To determine the device serial number, touch  >  >  **About device** > **Status**.

- Serial number - Displays the serial number.

---

## Chapter Descriptions

Topics covered in this guide are as follows:

- [Chapter 1, Getting Started](#), describes the features and basic operation of the TC8000, lists the accessories for the TC8000 and explains how to install and charge the batteries and start the TC8000 for the first time.
- [Chapter 2, Using the TC8000](#), provides instructions for connecting the TC8000 to a host computer and using the OS desktop of the TC8000.
- [Chapter 3, Data Capture](#), provides information for capturing bar code data.
- [Chapter 4, Wireless](#), provides information on the various wireless options.
- [Chapter 5, Applications](#), provides information on various applications pre-installed on the TC8000.
- [Chapter 6, Accessories](#), Accessories, provides information for using the accessories with the TC8000.
- [Chapter 7, Maintenance and Troubleshooting](#), includes instructions on cleaning and storing the TC8000, and provides troubleshooting solutions for potential problems during TC8000 operation.
- [Appendix A, Specifications](#), includes a table listing the technical specifications for the TC8000 and accessories.

---

## Notational Conventions

The following conventions are used in this document:

- *Italics* are used to highlight the following:
  - Chapters and sections in this guide
  - Related documents
- **Bold** text is used to highlight the following:
  - Dialog box, window and screen names
  - Drop-down list and list box names
  - Check box and radio button names
  - Icons on a screen
  - Key names on a keypad
  - Button names on a screen
- Bullets (•) indicate:
  - Action items
  - Lists of alternatives
  - Lists of required steps that are not necessarily sequential
  - Sequential lists (e.g., those that describe step-by-step procedures) appear as numbered lists.



**NOTE** This symbol indicates something of special interest or importance to the reader. Failure to read the note will not result in physical harm to the reader, equipment or data.



**CAUTION** This symbol indicates that if this information is ignored, the possibility of data or material damage may occur.



**WARNING!** This symbol indicates that if this information is ignored the possibility that serious personal injury may occur.

---

## Related Documents and Software

The following documents provide more information about the TC8000 touch computers.

- *TC8000 Quick Start Guide*, p/n MN002271Axx
- *TC8000 Regulatory Guide*, p/n MN002270Axx
- *TC8000 Integrator Guide for Android Version 5.1.1*, p/n MN-002899-xx
- *TC8000 Accessory Regulatory Guide*, p/n MN-002898-xx
- *Desk Mount Installation Guide*, p/n MN002413Axx
- *Rack/Wall Mount Installation Guide*, p/n MN002412Axx

For the latest version of this guide and all guides, go to: <http://www.zebra.com/support>.

---

## Service Information

If you have a problem with your equipment, contact Customer Support for your region. Contact information is available at: <http://www.zebra.com/support>.

When contacting Customer Support, please have the following information available:

- Serial number of the unit
- Model number or product name
- Software type and version number.

We respond to calls by E-mail, or telephone within the time limits set forth in support agreements.

If your problem cannot be solved by Zebra Support, you may need to return your equipment for servicing and will be given specific directions. Zebra is not responsible for any damages incurred during shipment if the approved shipping container is not used. Shipping the units improperly can possibly void the warranty.

If you purchased your business product from a business partner, contact that business partner for support.

---

## Provide Documentation Feedback

If you have comments, questions, or suggestions about this guide, send an email to [EVM-Techdocs@zebra.com](mailto:EVM-Techdocs@zebra.com).

# CHAPTER 1 GETTING STARTED

---

## Introduction

This chapter describes the features of the TC8000 and explains how to install and charge the battery and how to reset the TC8000.

## Unpacking

Carefully remove all protective material from the TC8000 and save the shipping container for later storage and shipping.

Verify that box contains all the equipment listed below:

- TC8000
- Battery
- hand strap
- Regulatory Guide.

Inspect the equipment for damage. If you are missing any equipment or if you find any damaged equipment, contact Support immediately. See [Service Information on page xvi](#) for contact information.

## Removing the Screen Protection Film

A screen protection film is applied to the TC8000 screen to protect the screen during shipping. To remove the screen protector, carefully lift the thin film off the display.

## Features

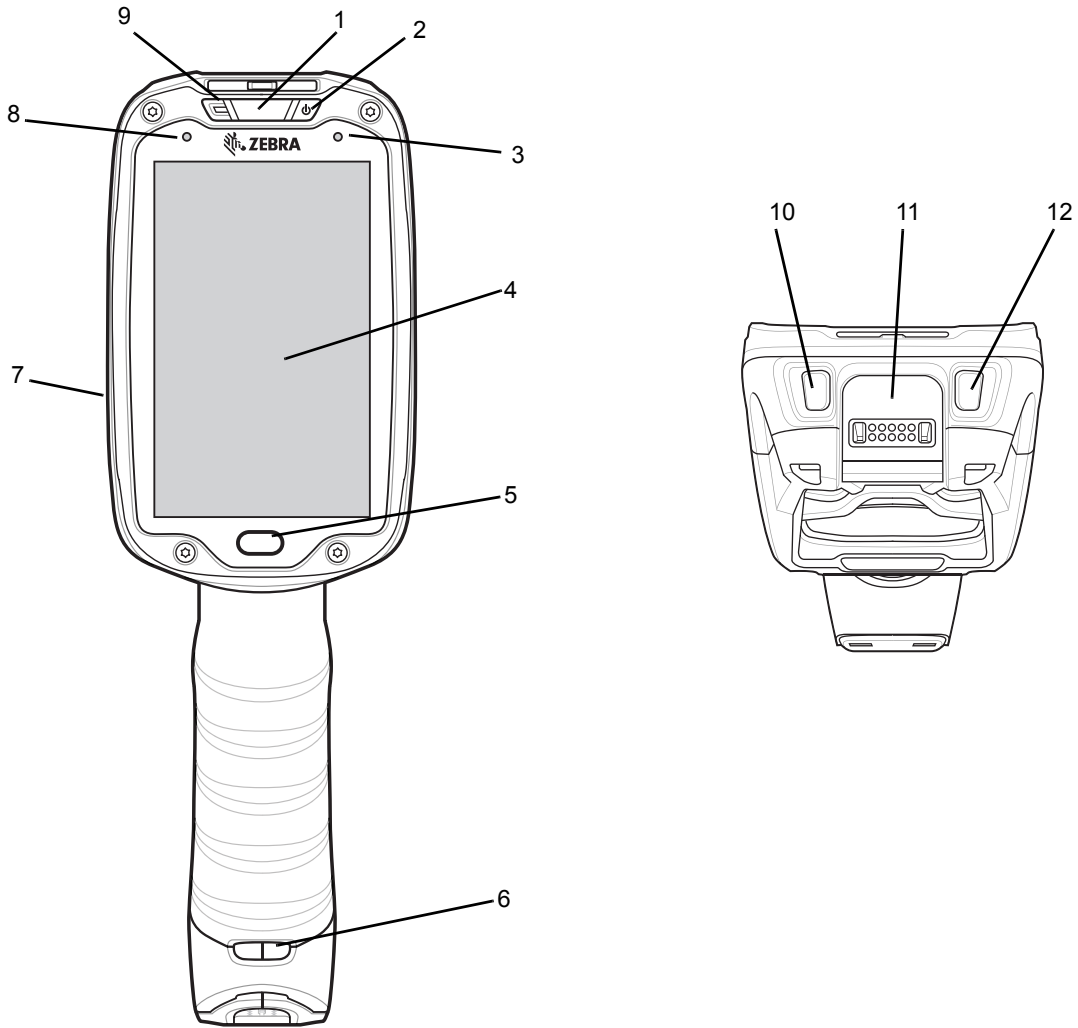
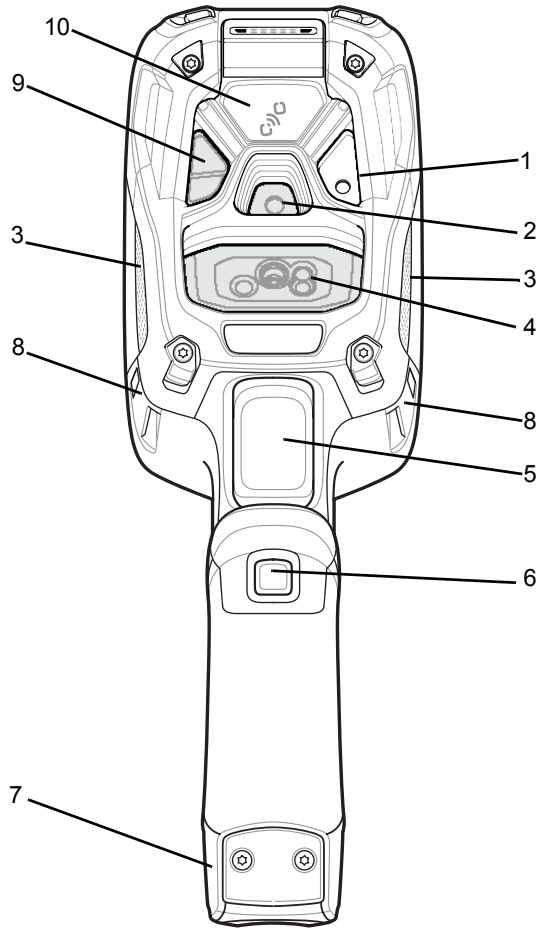


Figure 1-1 Front View

## Front View Descriptions

**Table 1-1** *Front View Descriptions*

Number	Item	Function
1	Charging/Scan LED	Indicates battery charging status while charging, good decode indication during data capture and application generated notifications.
2	Power Button	Turns the display on and off. Press and hold to reset the device and power off.
3	Blue Indication LED	User programmable LED.
4	Display	Displays all information needed to operate the TC8000.
5	Touch Button	Press to select items.
6	Hand Strap Mounting Point	Use for installing the optional hand strap.
7	Speakers	Provides audio output for video and music playback.
8	Ambient Light Sensor	Determines ambient light for controlling display backlight intensity (optional).
9	Microphone	Use for communication in Headset mode.
10	Volume Up Button	Increases audio volume (programmable).
11	Interface Connector	Provides USB host and client communication, audio and device charging via cables and accessories.
12	Volume Down Button	Decreases audio volume (programmable).



**Figure 1-2** *Back View*



## Back View Descriptions

**Table 1-2** *Back View Descriptions*

Number	Item	Function
1	Camera Flash	Provides illumination for the camera (optional).
2	Camera	Takes photos and videos (optional).
3	Speaker	Provides audio output.
4	Scanner	Provides data capture using the imager or laser scanner.
5	Trigger	Initiates data capture (programmable).
6	Push-To-Talk (PTT) Button	Initiates Push-To-Talk communication (programmable).
7	Battery Pack	Provides power to the device.
8	Hand Strap Mounting Point	Use for installing the optional hand strap.
9	Proximity Sensor	Long range proximity sensor (optional).
10	NFC tag	Tap-to-Pair using NFC (Near Field Communication)

## Setup

Perform these procedures to start using the TC8000 for the first time.

1. Install a microSD card.
2. Install the battery.
3. Charge the TC8000.
4. Power on the TC8000.

### Installing the microSD Card

The microSD card slot provides secondary non-volatile storage. The slot is located under the back bezel of the unit. Refer to the documentation provided with the card for more information, and follow the manufacturer's recommendations for use.



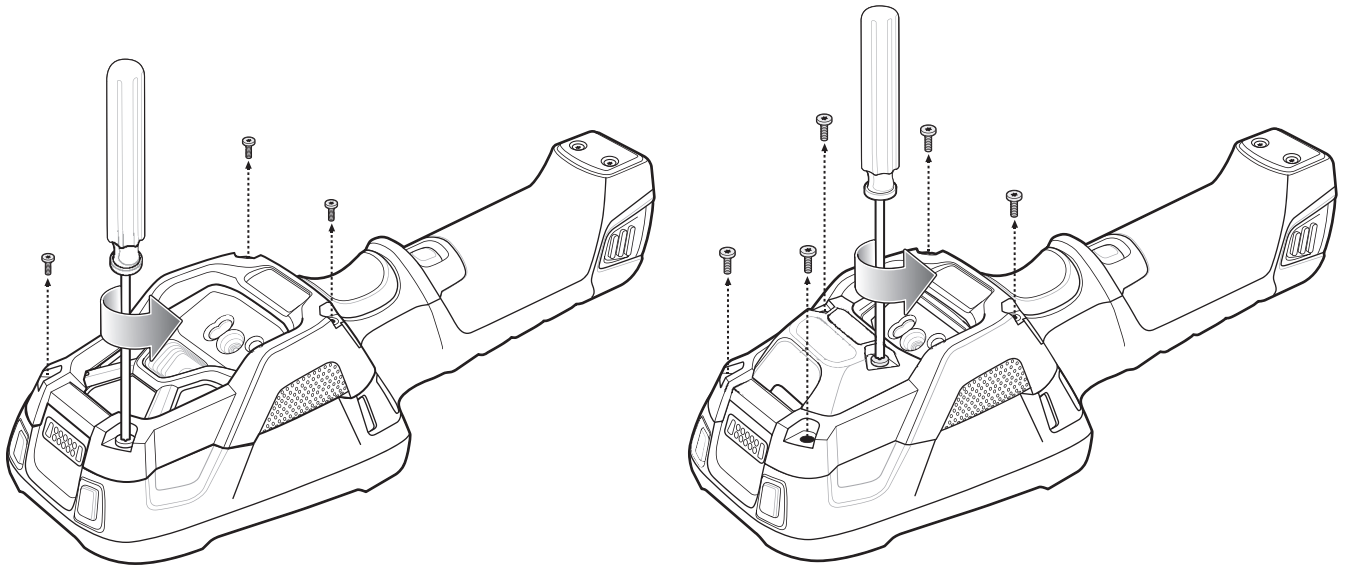
**WARNING!** Follow proper electrostatic discharge (ESD) precautions to avoid damaging the microSD card. Proper ESD precautions include, but are not limited to, working on an ESD mat and ensuring that the operator is properly grounded.



**NOTE** The Condensation Resistant configuration has six screws securing the back bezel.

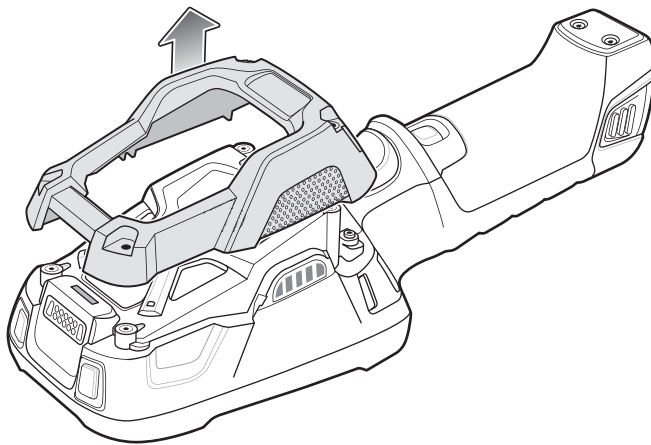
When installing a microSD card on Condensation Resistant configurations, replace the Back Bezel with desiccant pack. Refer to the *TC8000 Integrator Guide*. Once the Rear Bezel is removed, the desiccant pack absorbs ambient moisture and can lessen the life of the desiccant pack.

1. Remove the Torx T8 screws holding the back bezel in place.



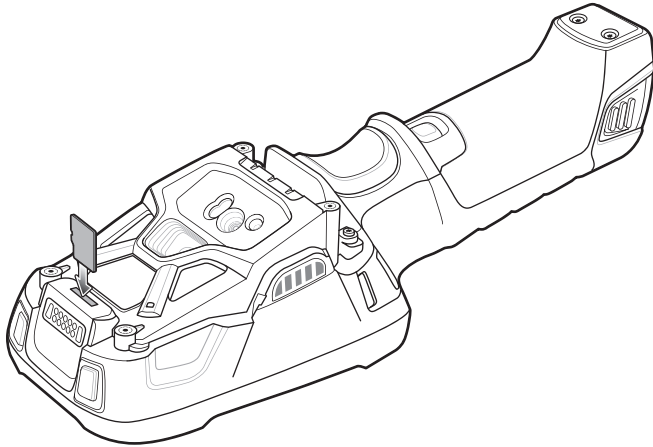
**Figure 1-3** Remove Screws

2. Lift the bezel to expose the SD slot.



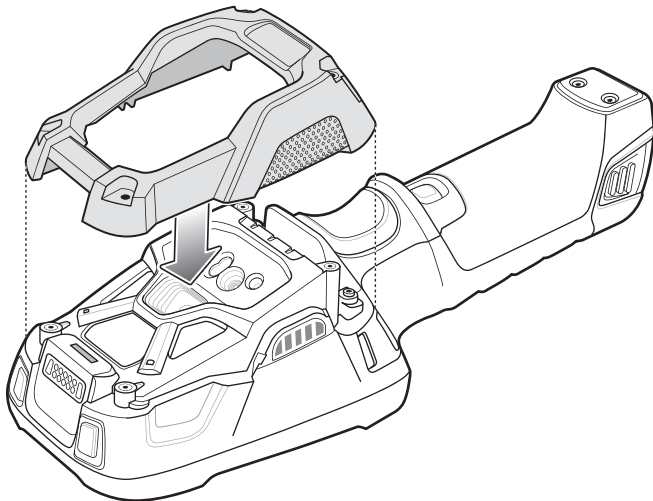
**Figure 1-4** Remove Bezel

3. Insert the microSD card into the slot with contacts facing the bottom of the device.



**Figure 1-5** *Insert microSD Card*

4. Align the bezel onto the device.



**Figure 1-6** *Align Bezel*

5. Tighten the four screws using T8 hex screwdriver.
6. Torque screws to 4.5 kg-cm.

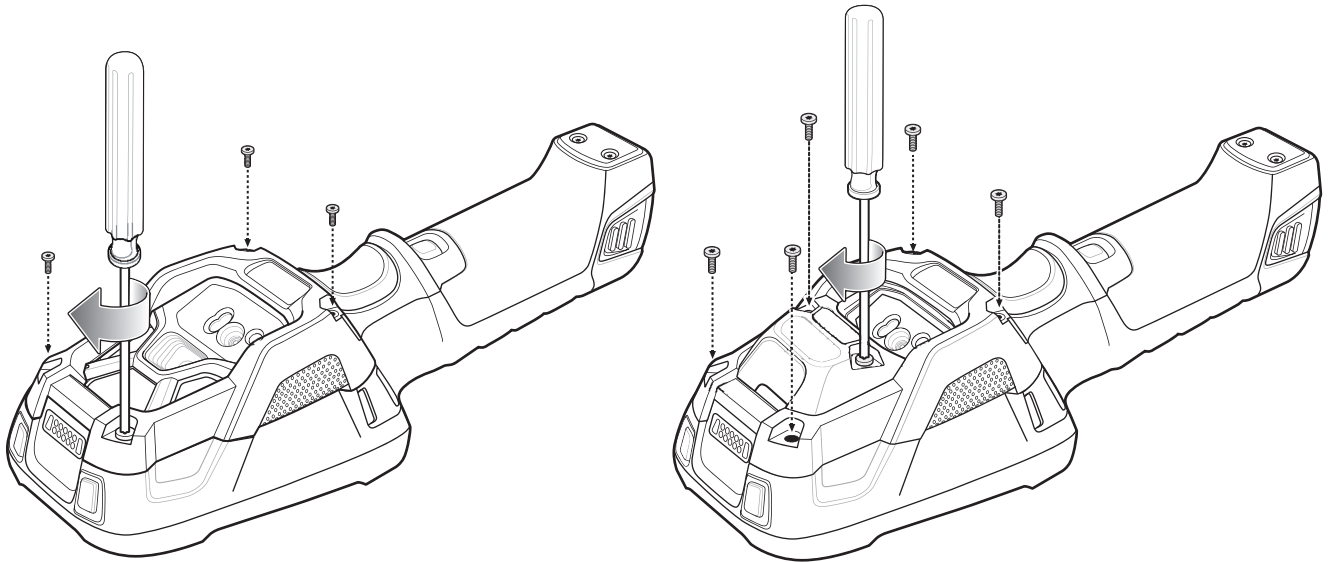


Figure 1-7 Secure Bezel

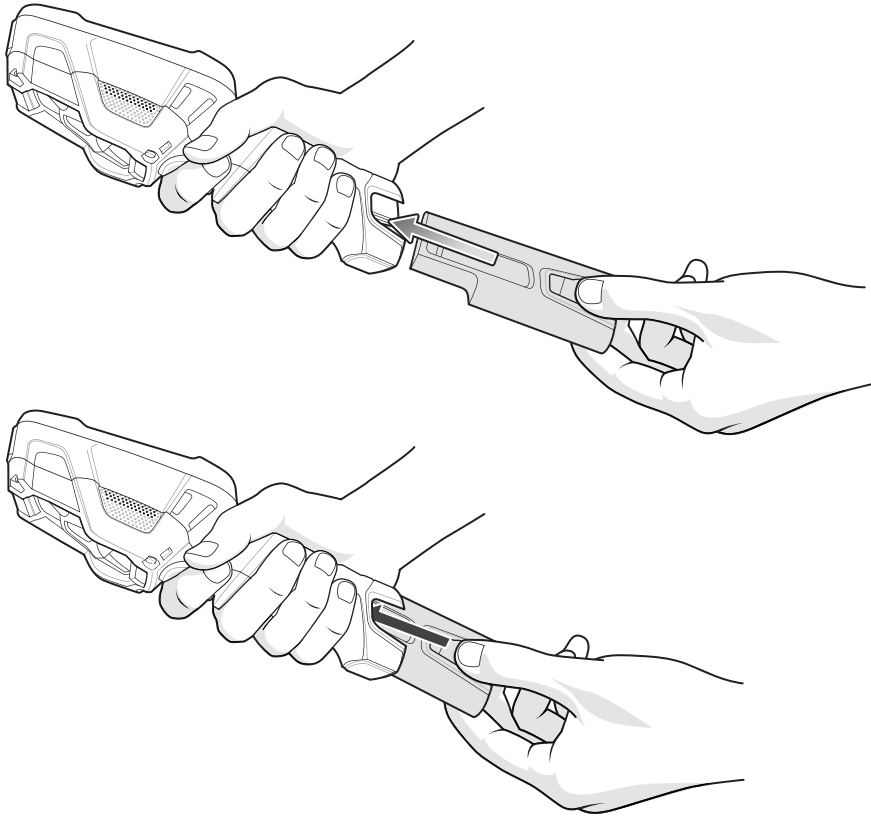
## Installing the Battery

To install the battery:



**NOTE** The battery is keyed to ensure that the battery is inserted properly. The notch in the battery must face the back of the device.

1. Align the battery with the notch facing the back of the device.
2. Slide the battery into the handle of the device.



**Figure 1-8** *Battery Installation*

3. Press the battery into the handle until it snaps into place.

## Charging the Battery

Before using the TC8000 for the first time, charge the battery using a cable or a cradle with the appropriate power supply. For information about the accessories available for the TC8000, see [Chapter 6, Accessories](#).

The TC8000 is equipped with a supercapacitor (supercap) which automatically charges from the fully-charged main battery. The supercap requires approximately 10 minutes to fully charge. The supercap retains random access memory (RAM) data in memory and WLAN connection for at least 30 seconds when the main battery is removed during Hot Swap. After 30 seconds, the WLAN connection is dropped and the RAM data is retained for 20 minutes.

- 4-Slot Battery Charger
- 2-Slot USB Charge Cradle
- 5-Slot Charge Only Cradle
- 5-Slot Ethernet Cradle
- 5-Slot Charge Only Cradle with 4-Slot Battery Charger
- 5-Slot Ethernet Cradle with 4-Slot Battery Charger.

The 6,700 mAh battery fully charges in approximately four hours at room temperature.

Charge batteries in temperatures from 0 °C to 40 °C (32 °F to 104 °F). The TC8000 or accessory always performs battery charging in a safe and intelligent manner. At higher temperatures (e.g. approximately +37 °C (+98 °F)) the TC8000 or accessory may for small periods of time alternately enable and disable battery charging to keep the

battery at acceptable temperatures. The TC8000 or accessory indicates when charging is disabled due to abnormal temperatures via its red blinking LED.

1. To charge the main battery, connect the charging accessory to the appropriate power source.
2. Insert the TC8000 into a cradle or attach to a cable. The TC8000 turns on and begins charging. The Charging/Scan LED lights amber while charging, then turns solid green when fully charged.

**Table 1-3** *Charging/Scan LED Charging Indicators*

State	Indication
Off	TC8000 is not charging. TC8000 is not inserted correctly in the cradle or connected to a power source. Charger/cradle is not powered.
Solid Amber	Healthy battery is charging.
Solid Green	Healthy battery charging is complete.
Fast Blinking Red (2 blinks/second)	Charging error, e.g.: - Temperature is too low or too high. - Charging has gone on too long without completion (typically eight hours).
Solid Red	Unhealthy battery is charging or fully charged.



**IMPORTANT**

When trying to power on the device, a quick blink of the charging LED indicates that it does not have enough battery power to turn on. You will need to charge the battery or replace it.

## Starting the TC8000

When installed in a cradle, the TC8000 starts automatically as soon as power is applied.

When a charged battery is installed and the TC8000 is turned off, press the Power button to turn on.

When the TC8000 is powered on for the first time, it initializes its system. The splash screen appears for a short period of time.



**Figure 1-9** *Splash Screen*

The splash screen is followed by the boot animation screen and then the **Home Screen**.

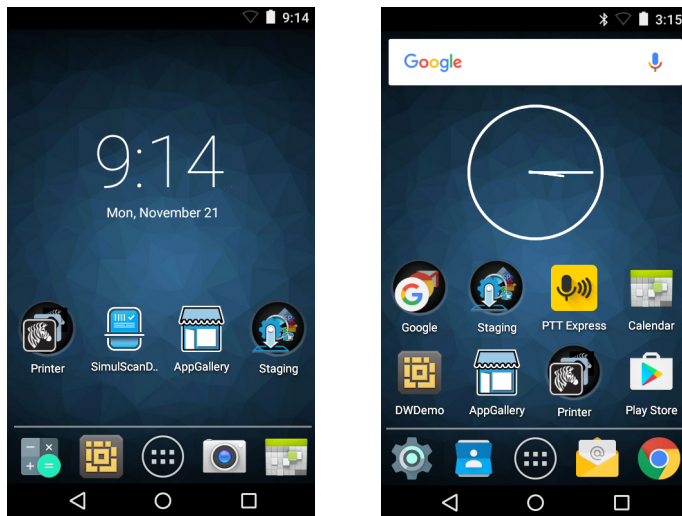


Figure 1-10 Home Screen - Non-GMS and GMS

---

## Google™ Account Setup

✓ **NOTE** The TC8000 has to be connected to the internet, through Wi-Fi, in order to set up a Google account.

The first time the TC8000 starts, the Setup Wizard displays. Follow the on-screen instructions to set up a Google account, configure Google Wallet for purchasing items from the Play Store, entering your personal information, and enabling backup/restore features.

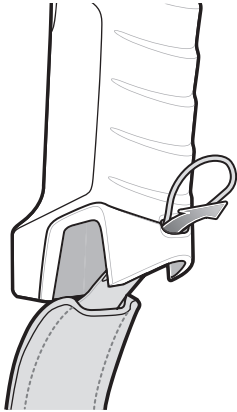
---

## Installing the Hand Strap

To install the hand strap:

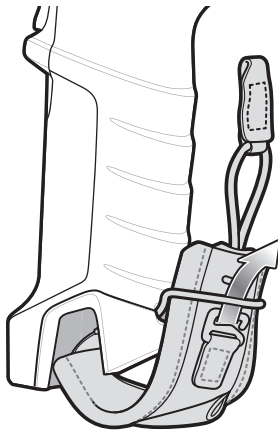
✓ **NOTE** Installation of the hand strap is optional. Skip this section if not installing the hand strap.

1. Remove battery if installed.
2. Thread the lanyard loop through the opening near the base of the handle.



**Figure 1-11** *Insert Loop through Handle Slot*

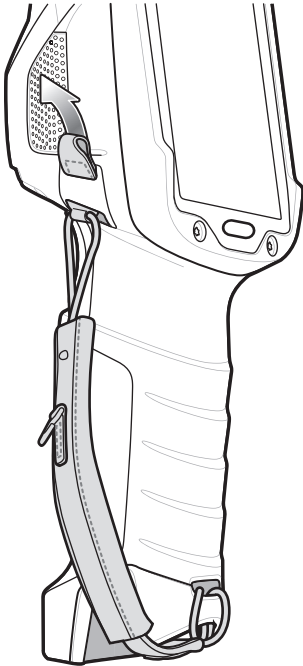
3. Insert the top end of the hand strap through the loop.



**Figure 1-12** *Thread Hand Strap Through Loop*

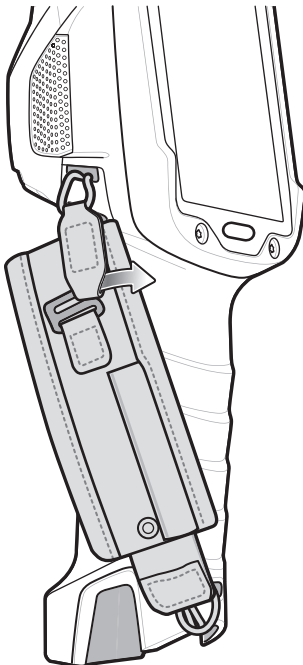
4. Thread the hand-strap through the lanyard.
5. Pull the hand strap through the loop.
6. Thread the lanyard through the slot on the left or right side of the unit, depending on your preference.





**Figure 1-13** Thread Tab Through Side Slot

7. Slide the tab onto the clip.



**Figure 1-14** Slide Tab onto Clip

---

## Hot Swap Mode

The TC8000 provides a Hot Swap mode where the user can replace the battery without powering off the device. When the user removes the battery, the display turns off and the Charging/Scan LED lights red while in Hot Swap mode.

In Hot Swap mode, the TC8000 stays connected to the Wi-Fi network for 30 seconds. Replace the battery within 30 seconds to preserve the active Wi-Fi session. After 30 seconds, the TC8000 establishes a new Wi-Fi connection.

After 30 seconds the TC8000 enters Standby mode. In Standby mode RAM is preserved for 20 minutes. If the user does not install a charged battery within 20 minutes, data in RAM will be lost.



**CAUTION** For the best battery swap experience, terminate your voice call before removing the battery pack.

---

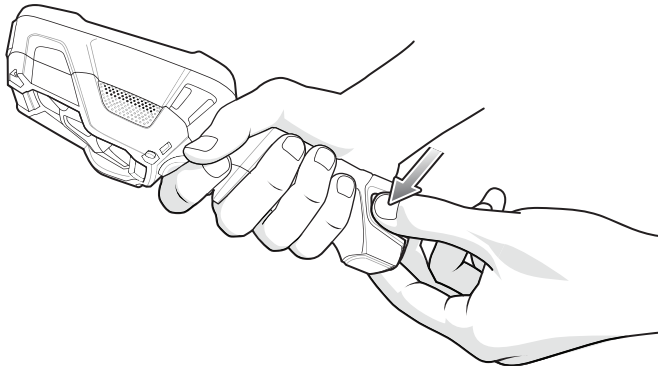
## Replacing the Battery

To remove the battery:



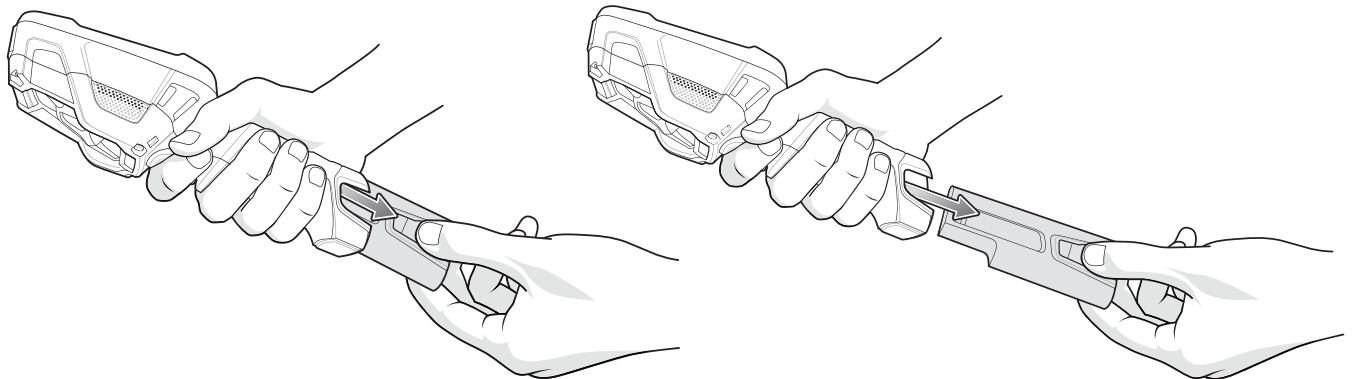
**CAUTION** Do not press the trigger while removing the battery.

1. Press the two battery release latches in.



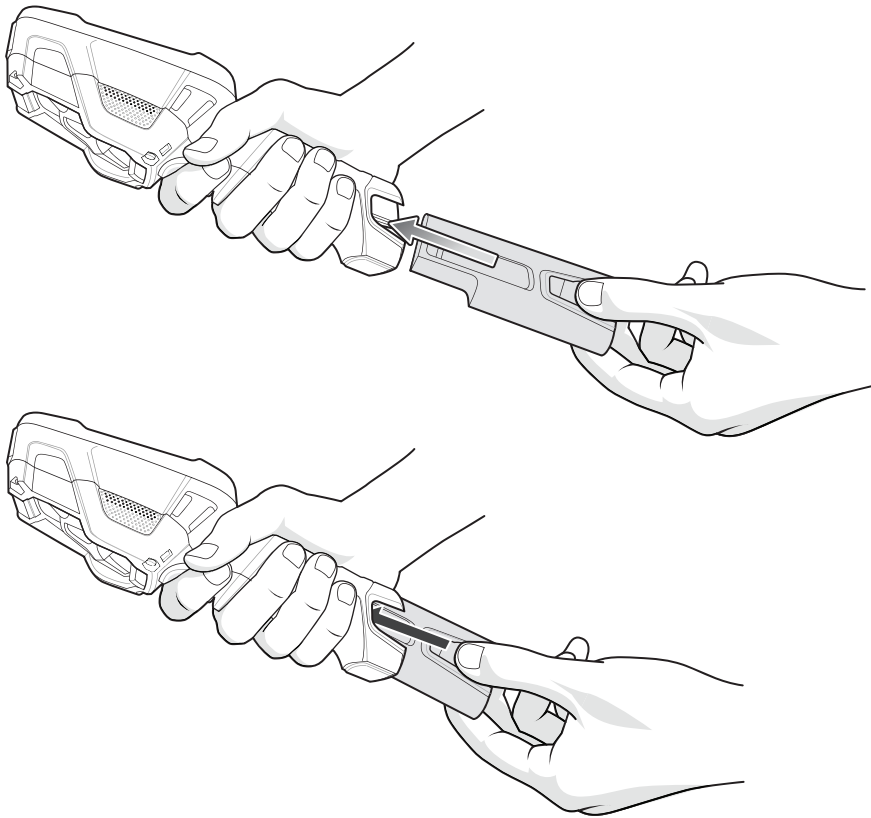
**Figure 1-15** Battery Removal

2. Pull the battery out of the device. The Charging/Scan LED lights red.



**Figure 1-16** Battery Removal

3. Align the replacement battery with the notch facing the back of the device.
4. Slide the battery into the handle of the device.





**Figure 1-17** *Battery Installation*

5. Press the battery into the handle until it snaps into place.

---

## Battery Management

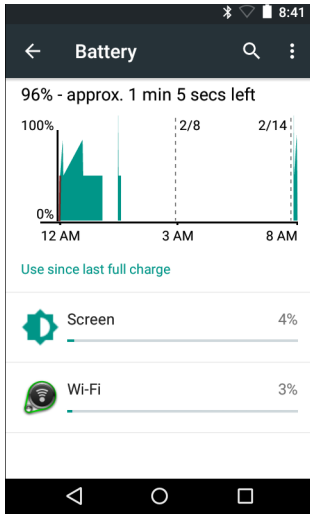
To check the charge status of the main battery, on the Home screen touch  >  >  **About device** > **Status**.

**Battery status** indicates that the battery is discharging (not charging) and **Battery level** lists the battery charge (as a percentage of fully charged).

## Monitor Battery Usage

The Battery screen lists which applications consume the most battery power. Also use it to turn off applications that were downloaded if they are consuming too much power.

Touch  >  >  **Battery**.



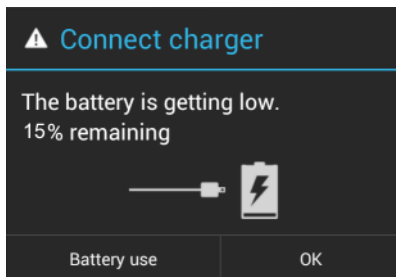
**Figure 1-18** Battery Screen

The Battery screen lists the applications using the battery. The discharge graph at the top of the screen shows the rate of the battery discharge since last charged (short periods of time when connected to a charger are shown as thin green lines at the bottom of the chart), and how long it has been running on battery power.

Touch an application in the Battery screen to display details about its power consumption. Different applications display different information. Some applications include buttons that open screens with settings to adjust power use.

## Low Battery Notification

When the battery charge level drops below 15%, the TC8000 displays a notice to connect the TC8000 to power. Place the TC8000 into a cradle to charge the battery.



**Figure 1-19** Low Battery Notification

When the battery charge drops below 10%, the TC8000 displays a notice to connect the TC8000 to power. The user must charge the battery using one of the charging accessories.

When the battery charge drops below 5%, the TC8000 turns off.

Place the TC8000 into a cradle to charge the battery.



**NOTE** Under conditions of heavy load (scanning quickly and often, RF communication, etc.) the TC8000 may turn off earlier than 5% charge remaining.





## Battery Optimization

Observe the following battery saving tips:

- Set the screen to turn off after a short period of non-use. See *Setting Screen Timeout Setting on page 1-18*.
- Reduce screen brightness. See *Setting the Screen Brightness on page 1-18*.
- Turn off all wireless radios when not in use.
- Turn off automatic syncing for Email, Calendar, Contacts and other applications.
- Use the Power Control widget to check and control the status of radios, the screen brightness, and syncing.
- Minimize use of applications that keep the TC8000 from suspending, for example, music and video applications.

## Turning Off the Radios

To turn off all the radios:

1. Touch  >  >  **More**.
2. Touch **Airplane mode**. The airplane icon  appears in the Status bar indicating that all the radios are off.







**NOTE** Alternately, you can place the device into **Airplane mode** using the **Quick Settings** option.

---

## Setting the Date and Time

The date and time is automatically synchronized using an NTP server when the TC8000 is connected to a wireless network. The user is only required to set the time zone or set the date and time when not connected to a wireless network. To manually change the date and time:

1. Touch  >  >  **Date & time**.
2. Touch **Automatic date & time** to disable automatic date and time synchronization.
3. Touch **Set date**.
4. Select the month, date and year.
5. Touch **OK**.
6. Touch **Set time**.
7. Select the hour, minutes and part of the day.
8. Touch **OK**.
9. Touch **Select time zone**.
10. Select the current time zone from the list.
11. Touch .




---

## Display Setting

Use Display settings to change the screen brightness, set sleep time and change font size.

## Setting the Screen Brightness

To set the screen brightness:

1. Touch  >  >  **Display**.
2. Touch **Adaptive Brightness** to automatically adjust the brightness using the built-in light sensor. Touch to disable adaptive brightness and set the brightness manually.
3. Touch **Brightness** to set the brightness level manually.
4. Use the slider to set a brightness level.

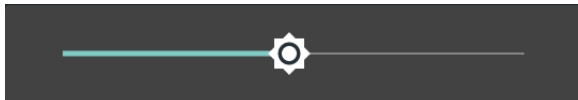






Figure 1-20 *Brightness Dialog Box*

5. Touch .





## Setting Screen Timeout Setting

To set the screen sleep time:

1. Touch  >  >  **Display** > **Sleep**.
2. Select one of the sleep values.
  - **15 seconds**
  - **30 seconds**
  - **1 minute**
  - **2 minutes**
  - **5 minutes** (default)
  - **10 minutes**
  - **30 minutes**.
3. Touch .





## Setting Font Size

To set the size of the font in system applications:

1. Touch  >  >  **Display** > **Font size**.
2. Select one of the font size values.
  - **Small**
  - **Normal** (default)
  - **Large**
  - **Huge**.
3. Touch .

## Setting Screen Rotation




The user can set the screen to rotate 90 degrees left or right.

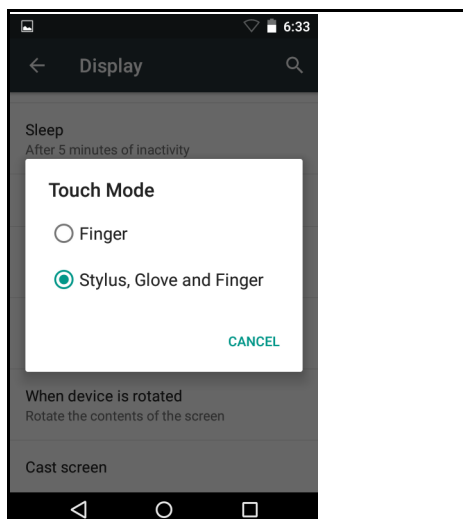
1. Touch  >  >  **Display** > **When device is rotated**.
2. Touch one of the following options:
  - **Rotate the contents of the screen** - automatically switch orientation when the screen is rotated.
  - **Stay in portrait view** - does not switch orientation when the screen is rotated.
3. Touch .

## Touch Mode

The TC8000 display is able to detect touches using a finger, a conductive-tip stylus or gloved finger.

✓ **NOTE** A glove can be made of medical latex, leather, cotton or wool.  
For optimal performance use Zebra certified stylus.

1. Touch  >  >  **Display**.
2. Touch **Touch Mode**.
3. Touch **Finger** to use a finger on the screen or touch **Stylus, Glove and Finger** (default) to use a stylus, finger or a gloved finger on the screen.



**Figure 1-21** Touch Mode Dialog Box

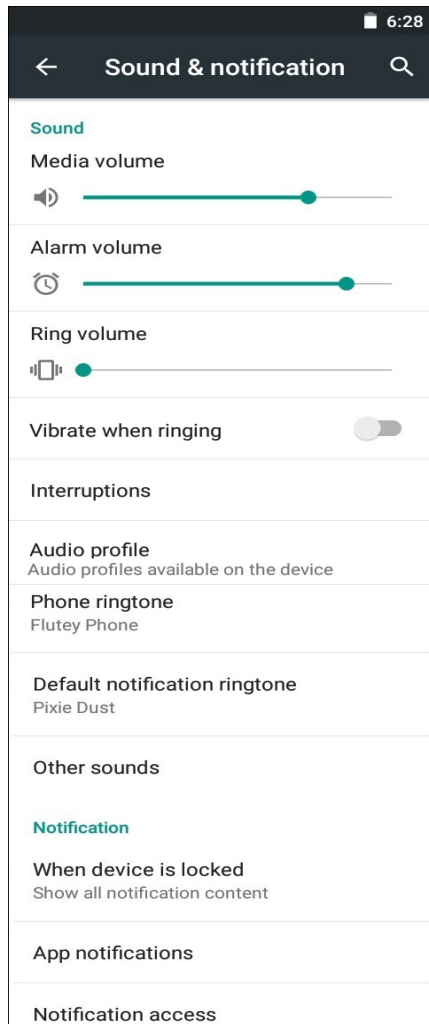
4. Touch **UPDATE** to confirm reboot. The Touch Mode configuration change reboots the device.



**IMPORTANT** Do not power off, reboot or perform a battery swap during this operation.

## General Sound Setting

Use the **Sound & notification** settings to configure media, alarm, and ring volumes, and to set notifications. On the Home screen, touch  >  >  **Sound & notification**.



**Figure 1-22** Default Sound & Notification Screen



- **Sound**
  - **Media volume** - Controls the music, games and media volume.
  - **Alarm volume** - Controls the alarm clock volume.
  - **Ring volume** - Controls the ringtone volume.
  - **Vibrate when ringing** - Touch to enable the TC8000 to also vibrate on incoming calls (VoIP telephony ready only).
  - **Interruptions** - Use to prioritize sound notifications. Touch the settings to turn call and message interruptions on or off.  
If user turns Messages notifications on, touch **Calls/messages from** to specify from whom to accept notifications (**Anyone**, **Starred contacts only** or **Contacts Only**).  
In **Downtime** section, select which days and times to allow for sound notifications.
  - **Audio profile** – Touch to set audio profile. On the **Audio profile** screen, touch **Audio profile**.
    - **General** – Standard audio settings (default).
    - **Increased clarity** – Increased volume on higher frequencies.

---

#### Audio profile

- general
- increased clarity

CANCEL

---

**Figure 1-23** *Audio Profile Dialog Box*




- **Phone ringtone** - Touch to select a sound to play on incoming calls when a VoIP call is received. (VoIP telephony ready only).
- **Default notification ringtone** - Touch to select a sound to play for all system notifications.
- **Other sounds**
  - **Dial pad tones** - Plays a sound when a dial pad key is touched (default – enabled)
  - **Screen locking sounds** - Plays a sound when locking and unlocking the screen (default – enabled)
  - **Touch sounds** - Plays a sound when making screen selections (default – enabled).
  - **Vibrate on touch** - Vibrates when making screen selections (default – enabled).
- **Notification**
  - **When device is locked** - Manage whether notifications can be seen when the TC8000 is locked.
    - **Show all notification content** - Notifications and their details display on the lock screen.
    - **Hide sensitive notification content** - Notifications display on the lock screen, but any details that could reveal private information is automatically hidden.
    - **Don't show notifications at all** - Notifications do not display on the lock screen. Notifications display once the device is unlocked.
  - **App notifications** - Modify the notification settings individually for an application. The setting under **When device is locked** always takes precedence over the setting for an individual application.
  - **Notification access** - Displays which applications can access notifications.

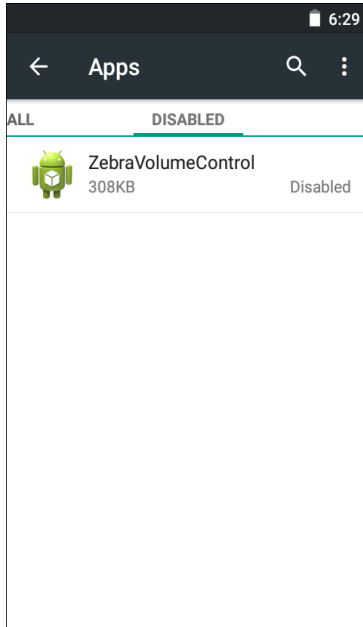
When a notification arrives, its icon appears at the top of the screen. Icons for pending notifications appear on the left, and system icons on the right.

## Zebra Volume Control

By default, Zebra Volume Control is not enabled.

To enable Zebra Volume Control:




1. From the Home screen, touch  >  >  **Apps**.
2. Swipe the screen right or left until the **Disabled** tab appears.

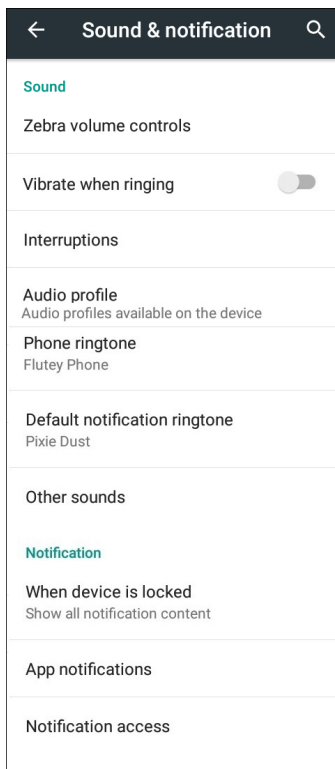


**Figure 1-24** *Disabled Tab*

3. Touch **ZebraVolumeControl**.
4. Touch **ENABLE**.

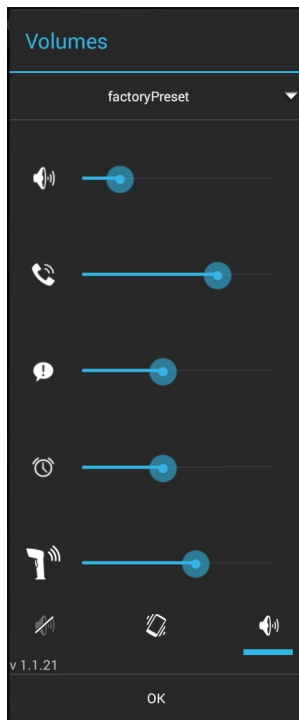
To set the Zebra volume controls after it is enabled:

1. From the Home screen, touch  >  >  **Sound & notification**.  
The **Zebra volume controls** setting appears and can be configured.
2. Touch **Zebra volume controls**.











**Figure 1-25** *Zebra Volume Controls Enabled*

3. On the **Volumes** screen, slide each setting as desired.



**Figure 1-26** *Volumes Screen*

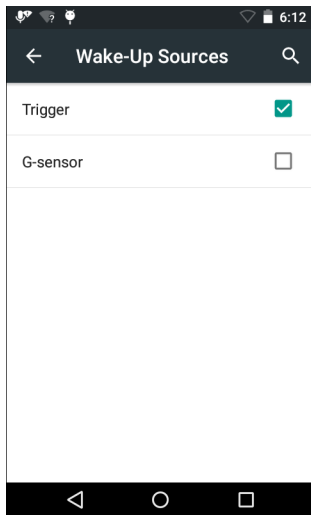
- Volume Controls
  -  - Controls the music, games and media volume.
  -  - Controls the ringtone volume.
  -  - Controls the system notification volume.
  -  - Controls the alarm clock volume.
  -  - Controls the scan good decode beep volume.
- Bottom row icons:
  -  - Places all sounds except media and alarms in silence mode.
  -  - Places all sounds except media and alarms in vibrate mode.
  -  - Places all sounds in sound mode.

---

## Wake-Up Sources

By default the TC8000 wakes from suspend mode when one of the activities in the screen below occurs. The user can disable any of these wake-up sources.

1. Touch  >  >  **Wake-Up Sources**.
2. Touch a checkbox to enable or disable the source.



**Figure 1-27** *Wake-Up Sources Dialog Box*

3. Touch .



# CHAPTER 2 USING THE TC8000

---

## Introduction

This chapter describes the screens, status and notification icons, and controls on the TC8000, and provides basic instructions for using the TC8000.

---


## Google Mobile Services



**NOTE** This section only applies to TC8000 configurations with Google Mobile Services (GMS).

The TC8000 with GMS contains applications and services that provide additional functionality to the TC8000.


GMS includes:

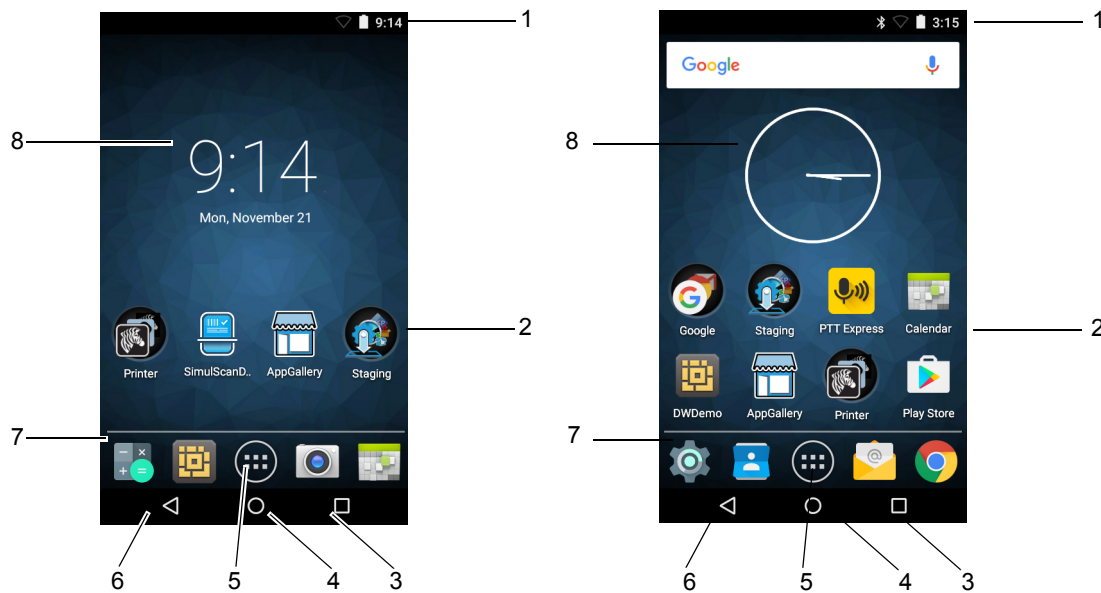
- **Applications** - GMS adds a variety of Google applications and associated widgets including Chrome, Gmail, Drive and Maps.
- **Services:**
  - **Speech to Text** - Allows for free format speech to text, in many languages for both connected and disconnected network. Launch by touching the microphone icon on the keyboard.
  - **TalkBack Service** - Provides spoken feedback on various parts of the user interface. To enable, go to **Settings > Accessibility**.
  - **Network Location Provider** - Adds a location provider which uses mobile network tower information and Wi-Fi access point information to provide a location without using GPS. To enable, touch  **Settings > Location**.
  - **Widevine DRM** - Enables the digital rights management so that protected content can be played. Enable via DRM Info from the Play Store.
  - **Google Cloud Messaging** - Allows the sending of data from your server to your TC8000 and also to receive messages from devices on the same connection.
  - **Backup and Restore** - Allows the users settings and applications to be backed up to a Google server and subsequently restored from that server after a factory reset.

- **Google accounts** - Create and use a Google account to synchronize mail, files, music, photos, contacts and calendar events.

## Home Screen

The Home screen displays when the TC8000 turns on. Depending upon the configuration, the Home screen might appear different. Contact your system administrator for more information.

After a suspend or screen time-out, the Home screen displays with the lock sliders. Slide  up to unlock the screen. For screen locking information see *Un-Locking the Screen on page 2-15*.



**Figure 2-1** Home Screen - Non-GMS and GMS

- ✓ **NOTE** The Home screen icons can be configured by the user and may look different than shown. On TC8000 devices without a camera the Camera icon does not appear.

The Home screen consists of the following:

**Table 2-1** Home Screen Items

Item	Description
1 — Status Bar	Displays the time, status icons (right side), and notification icons (left side). For more information see <i>Status Icons on page 2-3</i> and <i>Managing Notifications on page 2-6</i> .
2 — Folders	Contains multiple application icons.
3 — Menu Icon	Displays running applications.
4 — Home Icon	Displays the Home screen.
5 — All Apps Icon	Opens the APPS window.
6 — Back Icon	Displays the previous screen.




**Table 2-1** (Continued) Home Screen Items

Item	Description
7 — Shortcut Icons	Opens applications installed on the TC8000. See <i>Application Shortcuts and Widgets on page 2-7</i> for more information.
8 — Widgets	Launches stand-alone applications that run on the Home screen. See <i>Application Shortcuts and Widgets on page 2-7</i> for more information.

The Home screen provides four additional screens for placement of widgets and shortcuts. Swipe the screen left or right to view the additional screens.

## Status Bar

The Status bar displays the time, notification icons (left side) and status icons (right side).

If there are more notifications than can fit in the Status bar,  displays indicating that more notifications exist. Open the Notifications panel to view all notifications and status.

## Status Icons

**Table 2-2** Status Icons















Icon	Description
	Indicates that the Alarm is active.
	Indicates that all sounds except media and alarms are silenced and vibrate mode is active.
	Indicates that all sounds except media and alarms are silenced.
	Indicates that the battery is fully charged.
	Indicates that the battery is partially drained.
	Indicates that the battery charge is low.
	Indicates that the battery charge is very low.
	Indicates that the battery is charging.

Table 2-2 *Status Icons (Continued)*

Icon	Description
	Indicates that the Airplane Mode is active. All radios are turned off.
	Indicates that Bluetooth is on.
	Connected to a Wi-Fi network.
	Not connected to a Wi-Fi network or no Wi-Fi signal.
	Connected to an Ethernet network.
	Headset audio cable is connected to the device.

## Notification Icons

Table 2-3 *Notification Icons*





















Icon	Description
	Indicates that more notifications are available for viewing.
	Indicates that data is syncing.
	Indicates an upcoming event.
	Indicates that an open Wi-Fi network is available.
	Indicates that a song is playing.
	Indicates that a problem with sign-in or sync has occurred.

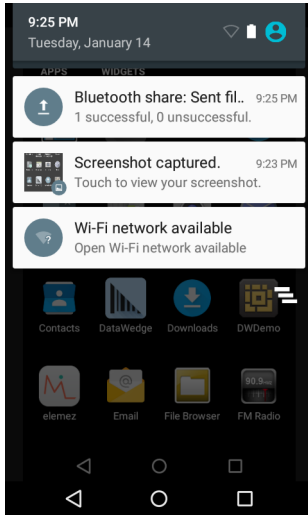
Table 2-3 Notification Icons (Continued)

Icon	Description
	Indicates that the device is uploading data.
	Indicates that the Internal Storage is almost full.
	Indicates that the device is downloading data when animated and download is complete when static.
	Indicates that the device is connected via USB cable.
	Indicates that the device is connected to or disconnected from virtual private network (VPN).
	Preparing Internal Storage.
	Indicates that USB debugging is enabled on the device.
	Screenshot captured.
	Error capturing screenshot.
	Indicates that the MultiUser feature is enabled. Appears only when MultiUser Administrator application is installed.
	Indicates that a new user is logging in. Appears only when MultiUser Administrator application is installed.
	Indicates that the RxLogger application is running and capturing data.
	Indicates the status of PTT Express Voice Client. See Notification Icons for complete list of PTT Express notification icons.
	Indicates that DataWedge application is running on the device.

## Managing Notifications


Notification icons report the arrival of new messages, calendar events, and alarms, as well as ongoing events. When a notification occurs, an icon appears in the Status bar with a brief description. See *Notification Icons on page 2-4* for a list of possible notification icons and their description. Open the Notifications panel to view a list of all the notifications.

To open the Notification panel, drag the Status bar down from the top of the screen.




**Figure 2-2** Notification Panel

To respond to a notification, open the Notifications Panel and then touch a notification. The Notifications Panel closes and the subsequent activity is dependent on the notification.

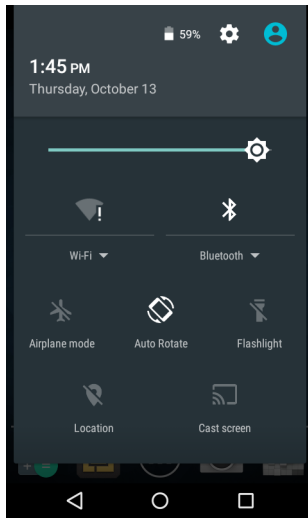
To clear all notifications, open the Notifications Panel and then touch . All event-based notifications are removed.

Ongoing notifications remain in the list.

To close the Notification Panel, drag the bottom of the Notifications Panel to the top of the screen or press .

## Quick Settings


Use Quick Settings to get to frequently used settings, like turning on airplane mode. To open Quick Settings, swipe down from the top of the screen with two fingers or twice with one finger.



**Figure 2-3** Quick Settings

To change a setting, just touch the icon:


- **Display Brightness** - Slide to lower or increase the brightness of the screen.
- **Wi-Fi** - Turn Wi-Fi on or off. To open Wi-Fi settings, touch the Wi-Fi network name.
- **Bluetooth** - Turn Bluetooth on or off. To open Bluetooth settings, touch the **Bluetooth**.
- **Airplane Mode** - Turn airplane mode on or off. Airplane mode means device will not connect to Wi-Fi or Bluetooth.
- **Auto-rotate:** - Lock the device's orientation in portrait or landscape mode or set to automatically rotate.
- **Flashlight** - Turn the camera LED flash on or off.
- **Location** - Turn location services on or off. To open location settings, touch
- **Cast Screen** - Share phone content on Chromecast or a television with Google Cast built-in. Touch cast screen to display a list of devices, then touch a device to begin casting.

To close the Quick Settings Panel, drag the bottom of the Quick Settings panel to the top of the screen or touch .

## Application Shortcuts and Widgets

Application shortcuts placed on the Home screen allow quick and easy access to applications. Widgets are self-contained applications placed on the Home screen to access frequently used features.


### Adding an Application or Widget to the Home Screen

1. Go to the desired Home screen.
2. Touch .
3. Swipe right, if necessary, to find the application icon or widget.
4. Touch and hold the icon or widget until the Home screen appears.
5. Position the icon on the screen and then release.

### Moving Items on the Home Screen

1. Touch and hold the item until it floats on the screen.
2. Drag the item to a new location. Pause at the edge of the screen to drag the item onto an adjacent Home screen.
3. Lift finger to place the item on the Home screen.

### Removing an App or Widget from the Home Screen

1. Go to the desired Home screen.
2. Touch and hold the application shortcut or widget icon until it floats on the screen.
3. Drag the icon to  Remove on the top of the screen and then release.

## Folders

Use Folders to organize similar applications together. Tap the folder to open and display items in the folder.

### Creating a Folder


To create a folder, there must be at least two app icons on the Home screen.

1. Go to the desired Home screen.
2. Touch and hold on one application icon.
3. Drag the icon and stack on top of another icon.
4. Lift and release.


### Naming Folders

1. Touch the folder.
2. Touch the title area and enter a folder name using the keyboard.
3. Touch **Done**.
4. Touch anywhere on the Home screen to close the folder. The folder name appears under the folder.

### Removing a Folder

1. Touch and hold the folder icon until it enlarges.
2. Drag the icon to  Remove and release.

## Home Screen Wallpaper

 **NOTE** Use of Live Wallpaper may reduce battery life.

### Changing the Home Screen Wallpaper


1. Touch and hold on the Home screen until the **Choose Wallpaper from** menu appears.
2. Touch **Wallpapers**, **Gallery**, or **Live wallpapers**.
  - **Wallpapers** - Select to use a wallpaper image.
  - **Gallery** - Select to use an image stored on the device.
  - **Live wallpapers** - Select to use an animated wallpaper image.
3. Touch **Save** or **Set wallpaper**.

## Using the Touchscreen

Use the multi-tap sensitive screen to operate the device.

- **Tap** - Tap to:
  - select items on the screen
  - type letters and symbols using the on-screen keyboard
  - press on-screen buttons.
- **Tap and Hold** - Tap and hold:
  - an item on the Home screen to move it to a new location or to the trash.
  - an item in the **All Apps** screen to create a shortcut on the Home screen.
  - the Home screen to open a menu for customizing the Home screen.
  - an empty area on the Home screen until the menu appears.
- **Drag** - Tap and hold an item for a moment and then move finger on the screen until reaching the new position.
- **Swipe** - Move finger up and down or left and right on the screen to:
  - unlock the screen
  - view additional Home screens
  - view additional application icons in the **All Apps** screen
  - view more information on an application's screen.
- **Double-tap** - Tap twice on a web page, map, or other screen to zoom in and out.
- **Pinch** - In some applications, zoom in and out by placing two fingers on the screen and pinching them together (to zoom out) or spreading them apart (to zoom in).

## Using the On-screen Keyboard



Use the on-screen keyboard to enter text in a text field. To configure the keyboard settings, touch and hold , (comma) >  and then select **Android keyboard settings**.

## Editing Text

Edit entered text and use menu commands to cut, copy, and paste text within or across applications. Some applications do not support editing some or all of the text they display; others may offer their own way to select text.

## Entering Numbers, Symbols and Special Characters

To enter numbers and symbols:

- Touch and hold one of the top-row keys until a menu appears then select a number. Keys with alternate characters display an ellipsis ( ... ) below the character.
- Touch and hold the Shift key with one finger, touch one or more capital letters or symbols to enter them, and then lift both fingers to return to the lowercase keyboard.
- Touch  to switch to the numbers and symbols keyboard.
- Touch the  key on the numbers and symbols keyboard to view additional symbols.

To enter special characters, touch and hold a number or symbol key to open a menu of additional symbols.

- A larger version of the key displays briefly over the keyboard.
- Keys with alternate characters display an ellipsis ( ... ) below the character.

## Applications

The APPS screen displays icons for all installed applications. The table below lists the applications installed on the TC8000. Refer to the TC8000 Integrator Guide for information on installing and uninstalling applications.

**Table 2-4** Applications








Icon	Description
	<b>App Gallery</b> - Provides links to utilities and demonstration applications that can be installed on the TC8000.
	<b>Battery Manager</b> - Displays battery information, including charge level, status, health and wear level.
	<b>Bluetooth Pairing Utility</b> – Use to pair Bluetooth devices with the TC8000 by scanning a bar code.
	<b>Browser</b> - Use to access the Internet or intranet. TC8000 with GMS only.
	<b>Calculator</b> - Provides the basic and scientific arithmetic functions.
	<b>Calendar</b> - Use to manage events and appointments.
	<b>Camera</b> - Take photos or record videos (optional).



Table 2-4 Applications (Continued)





























Icon	Description
	<b>Chrome</b> - Use to access the Internet or intranet. TC8000 with GMS only.
	<b>Clock</b> - Use to schedule alarms for appointments or as a wake-up.
	<b>Contacts</b> - Use to manage contact information.
	<b>DataWedge</b> - Enables data capture using the scanner, imager, or camera.
	<b>Downloads</b> - Lists all downloads files.
	<b>Drive</b> - Upload photos, videos, documents, and other files to personal storage site. TC8000 with GMS only.
	<b>DWDemo</b> - Provides a way to demonstrate the data capture features using the imager. See <i>RxLogger on page 5-26</i> for more information.
	<b>elemez</b> - Use to provide diagnostic information. See <i>Tap &amp; Pair on page 5-28</i> for more information.
	<b>Email</b> - Use to send and receive email.
	<b>File Browser</b> - Organize and manage files on the device. See <i>File Browser on page 5-12</i> for more information.
	<b>Gallery</b> - Use to view photos stored on the device. For more information, see <i>RxLogger on page 5-26</i> for more information.
	<b>Gmail</b> - Use to send and receive email using a Google email account. TC8000 with GMS only.
	<b>Google</b> - Launches Google search application. TC8000 with GMS only.
	<b>Google Settings</b> - Use to connect applications to Google account, setup Google Plus account, set location settings, set search features and configure Android Device Manager. TC8000 with GMS only.

Table 2-4 Applications (Continued)


Icon	Description
	<b>Hangouts</b> - Use to communicate with friends using text messages and photos. TC8000 with GMS only.
	<b>IST</b> - Use to configure sensor related features and view available sensors on the device, sensor information, and versions of each component in sensor subsystem.
	<b>Maps</b> - Use to see your location on a map (with public transit, traffic, or satellite overlays). Search for any business or place of interest. Provides turn-by-turn navigation with voice guidance and traffic-avoidance and alternate routes, for drivers, cyclists, walkers and users of public transportation. TC8000 with GMS only.
	<b>MLog Manager</b> - Use to capture log files for diagnostics. See <i>RxLogger</i> on page 5-26 for more information.
	<b>MobiControl Stage</b> - Opens the <b>MobiControl Stage</b> application to stage the device.
	<b>MSP Agent</b> - Enables management of the device from an MSP server. Requires the purchase of an appropriate MSP client license per device to suit the level of management functionality required.
	<b>Music</b> - Play music stored on the device. TC8000 without GMS only.
	<b>Photos</b> - Use to sync photos with Google account. TC8000 with GMS only.
	<b>Play Movies &amp; TV</b> - View movies and video on your device. TC8000 with GMS only.
	<b>Play Music</b> - Use to listen to music. TC8000 with GMS only.
	<b>Play Store</b> - Download music, movies, books, and Android apps and games from the Google Play Store. TC8000 with GMS only.
	<b>Print Station</b> - Use to print labels and receipts directly to a Zebra ZPL printer via USB, Bluetooth or WLAN.
	<b>PTT Express</b> - Use to launch PTT Express client for Voice over IP (VoIP) communication.
	<b>Rapid Deployment</b> - Allows the device to stage a device for initial use by initiating the deployment of settings, firmware and software. Requires the purchase of an MSP client license per device.

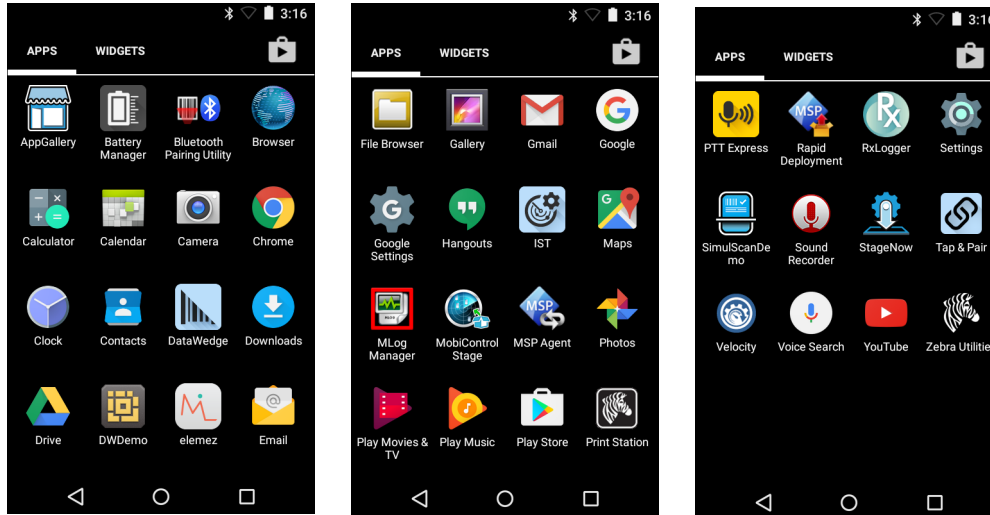
Table 2-4 Applications (Continued)

Icon	Description
	<b>RxLogger</b> - Use to diagnose device and application issues. See the <i>TC8000 Integrator Guide</i> for more information.
	<b>Search</b> - Use the Google search engine to search the Internet and the device. TC8000 without GMS only.
	<b>Settings</b> - Use to configure the device.
	<b>SimulScan Demo</b> - Use to demonstrate the document capture feature of the device. Simulscan supports devices with an SE4750 imager only.
	<b>Sound Recorder</b> - Use to record audio.
	<b>StageNow</b> - Allows the TC8000 to stage a device for initial use by initiating the deployment of settings, firmware and software.
	<b>Tap &amp; Pair</b> - Use to pair the TC8000 with a Zebra Bluetooth printer.
	<b>Velocity</b> - Opens the Wavelink terminal emulation application.
	<b>Voice Search</b> - Use to perform searches by asking questions. TC8000 with GMS only.
	<b>YouTube</b> - Use to view videos on the YouTube web site. TC8000 with GMS only.
	<b>Zebra Utilities</b> - Use to print bar code labels and receipts directly to a Zebra printer via Bluetooth or WLAN.
	<b>AppLock Administrator</b> - Use to configure the Application Lock feature. This icon appears after the optional application is installed. Download the application from the Zebra Support Central web site.
	<b>MultiUser Administrator</b> - Use to configure the MultiUser feature. This icon appears after the optional application is installed. Download the application from the Zebra Support Central web site.
	<b>Secure Storage Administrator</b> - Use to configure the Secure Storage feature. This icon appears after the optional application is installed. Download the application from the Zebra Support Central web site.

## Accessing Applications

All applications installed on the device are accessed using the **APPS** window.

1. On the Home screen, touch .




**Figure 2-4** APPS Window - Including GMS Apps

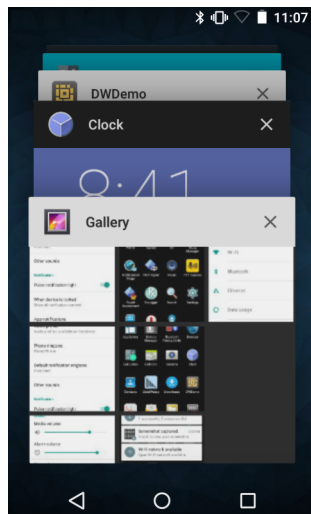
2. Slide the **APPS** window left or right to view more application icons. Touch an icon to open the application.



**NOTE** See *Application Shortcuts and Widgets* on page 2-7 for information on creating a shortcut on the Home screen.


## Switching Between Recent Applications

1. Touch . A window appears on the screen with icons of recently used applications.



**Figure 2-5** Recently Used Applications

2. Slide the window up and down to view all recently used applications.


3. Swipe left or right to remove application from the list and force close the application.
4. Touch an icon to open it or touch  to return to the current screen.

## Un-Locking the Screen

Use the Lock screen to protect access to data on the TC8000. Some email account require locking the screen. See *TC8000 Integrator Guide* for information on setting up the locking feature. The Locking feature functions differently in Single User mode or Multiple User mode.

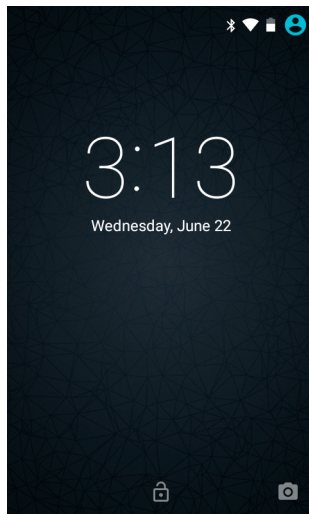
### Single User Mode

When locked, a pattern, PIN or password is required to unlock the device. Press the Power button to lock the screen. The device also locks after a pre-defined time-out.

Press and release the Power button to wake the device. The Lock screen displays. Slide  up to unlock the screen.

If the Pattern screen unlock feature is enabled, the Pattern screen appears instead of the Lock screen.

If the PIN or Password screen unlock feature is enabled, enter the PIN or password after unlocking the screen.



**Figure 2-6** Lock Screen

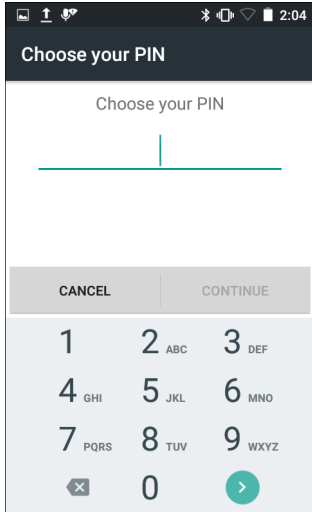


Figure 2-7 PIN Screen

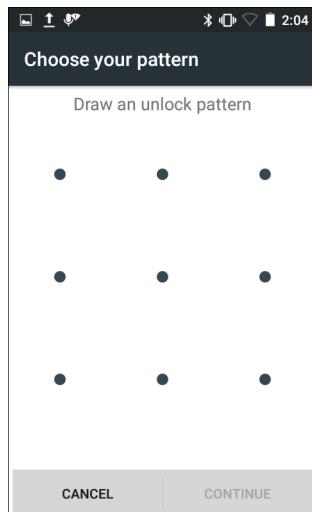
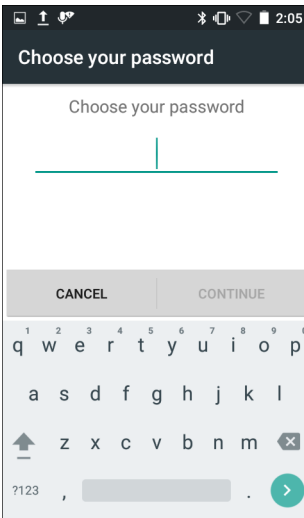


Figure 2-8 Pattern Screen



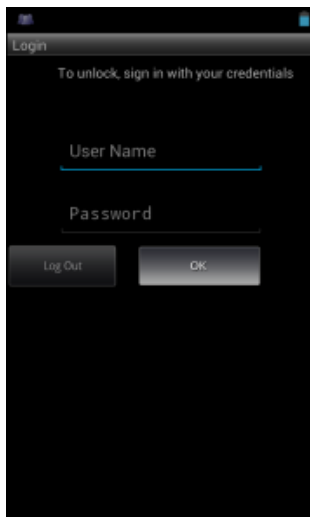
**Figure 2-9** Password Screen

## MultiUser Mode

With MultiUser login, multiple users can log on to the device with each user having access to various applications and features. When enabled, the Login screen appears after powering on, resetting or after the device wakes from suspend mode.

## MultiUser Login

1. In the **Login** text field, enter the username.



**Figure 2-10** Multiple User Log In Screen

2. In the **Password** text field, enter the password.
3. Touch **OK**. After a resume from suspend, the user must enter the password.

### MultiUser Logout


1. Drag the Status Bar down from the top of the screen.
2. Touch **MultiUser is active**.
3. Touch **Logout**.
4. The **Login** screen appears.

---

## Suspend Mode

The TC8000 goes into suspend mode when the user presses the Power button or after a period of inactivity (set in the Display settings window).

To wake the TC8000 from Suspend mode, press the Power button. Alternately, press the Trigger button to wake the device. The TC8000 can wake upon other actions. See *Wake-Up Sources on page 1-25* for options.

The Lock screen displays. Slide  up to unlock the screen. If the Pattern screen unlock feature is enabled, the Pattern screen appears instead of the Lock screen. See *Un-Locking the Screen on page 2-15*.

✓ **NOTE** If the user enters the PIN, password or pattern incorrectly five times, they must wait 30 seconds before trying again.

If the user forgets the PIN, password or pattern contact the system administrator.

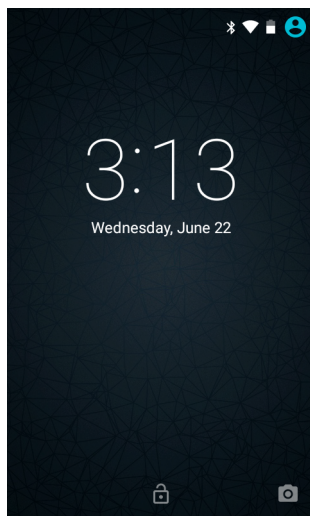


Figure 2-11 Lock Screen



---

## Interactive Sensor Technology

The TC8000 contains sensors that monitor movement, orientation and ambient light:

- **Gyroscope** - Measures angular rotational velocity to detect rotation of the device.
- **Accelerometer** - Measures the linear acceleration of movement to detect the orientation of the device.
- **Digital Compass** - The digital compass or magnetometer provides simple orientation in relation to the Earth's magnetic field. As a result, the device always knows which way is North so it can auto rotate your digital maps depending on your physical orientation.
- **Light Sensor** - Used to detect ambient light and adjust the screen brightness.
- **Proximity Sensor** - Uses to detect presence of nearby objects without physical contact.

In order to take advantage of these sensors, applications use API commands. Refer to the Zebra Android EMDK for more information.

---

## Resetting the TC8000

There are two reset functions:

- Soft reset
- Hard reset.

### Performing a Soft Reset

Perform a soft reset if applications stop responding.

1. Press the power button until the menu appears.
2. Touch **Reboot**.
3. The device reboots.

### Performing a Hard Reset



**CAUTION** Perform a hard reset only if the TC8000 stops responding.

To perform a hard reset, simultaneously press and hold the power button, trigger and PTT button for five seconds. When the device reboots, release the buttons and trigger.



# CHAPTER 3 DATA CAPTURE

---

## Introduction

✓ **NOTE** Not available on all configurations

The TC8000 has the following data capture options:

- integrated SE965 Standard Range Laser
- integrated SE4750-SR Standard Range Imager
- integrated SE4750-MR Mid-Range Imager
- integrated SE4850 Extended Range Imager
- integrated digital camera
- optional RS507 Hands-Free Imager.

✓ **NOTE** By default, the good decode beep is set to system volume (Notifications). The good decode beep can be set to another sound (Ringer, Music and Media or Alarms) and the volume can be independently controlled. See the DataWedge section in the *TC8000 Integrator Guide* for more information.

---

## Status LED

The Charging/Scan LED indicates data capture status. The LED lights green when a bar code is successfully decoded.

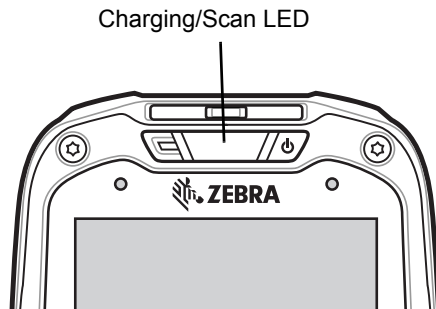


Figure 3-1 Charging/Scan LED

---

## Laser Scanning

The TC8000 with laser scanner has the following features:

- Reading of a variety of bar code symbologies, including the most popular linear, postal, and 1-D code types.
- Intuitive aiming for easy point-and-shoot operation.

---

## Imaging

The TC8000 with an integrated imager has the following features:

- Omnidirectional (360°) reading of a variety of bar code symbologies, including the most popular linear, postal, PDF417, and 2D matrix code types.
- The ability to capture and download images to a host for a variety of imaging applications.
- Advanced intuitive laser aiming for easy point-and-shoot operation.

The imager uses digital camera technology to take a digital picture of a bar code, stores the resulting image in its memory, and executes state-of-the-art software decoding algorithms to extract the data from the image.

## Operational Modes

The TC8000 with an integrated imager supports two modes of operation, listed below. Activate each mode pressing the Scan button.

- **Decode Mode:** In this mode, the TC8000 attempts to locate and decode enabled bar codes within its field of view. The imager remains in this mode as long as you hold the scan button, or until it decodes a bar code.
- **Pick List Mode:** This mode allows the user to selectively decode a bar code when more than one bar code is in the TC8000's field of view. To accomplish this, move the aiming crosshair or center dot over the required bar code to decode only this bar code. This feature is ideal for pick lists containing multiple bar codes and manufacturing or transport labels containing more than one bar code type (either 1D or 2D).



**NOTE** To enable Pick List Mode, configure in DataWedge or set in an application using a API command.

---

## Digital Camera

The device with an integrated camera based bar code scanning solution has the following features:

- Omnidirectional reading of a variety of bar code symbologies, including the most popular linear, postal, QR, PDF417, and 2D matrix code types.
- Cross-hair reticle for easy point-and-shoot operation.
- Picklist mode to decode a particular bar code from many in the field of view.

The solution uses the advanced camera technology to take a digital picture of a bar code, and executes state-of-the-art software decoding algorithms to extract the data from the image.

---

## Scanning Considerations

Scanning consists of; aim, scan and decode. Scanning performance can be optimized by considering the range and the scanning angle:

- Range

Any scanning device decodes well over a particular working range (minimum and maximum distances from the bar code). This range varies according to bar code density and scanning device optics.

Scanning within range brings quick and constant decodes; scanning too close or too far away prevents decodes. Move the scanner closer and further away to find the right working range for the bar codes being scanned. However, the situation is complicated by the availability of various integrated scanning modules. The best way to specify the appropriate working range per bar code density is through a chart called a decode zone for each scan module. A decode zone simply plots working range as a function of minimum element widths of bar code symbols.

- Angle

The scan angle is important for optimizing decode performance. When laser beams reflect directly back into the scanner from the bar code, this specular reflection can “blind” the scanner.

To avoid this, scan the bar code so that the beam does not bounce directly back. But do not scan at too sharp an angle; the scanner needs to collect scattered reflections from the scan to make a successful decode. Practice quickly shows what tolerances to work within.



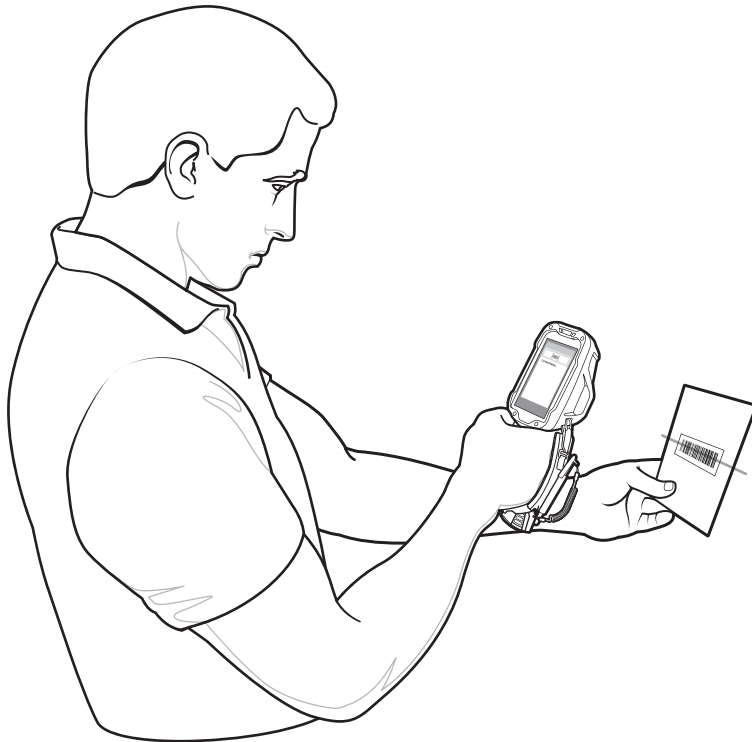
**NOTE** Contact the Zebra Support if chronic scanning difficulties develop. Decoding of properly printed bar codes should be quick and effortless.

---

## Bar Code Capture with Laser Scanner

To read a bar code, a scan-enabled application is required. The TC8000 contains the **DataWedge** application that allows the user to enable the scanner to decode bar code data and display the bar code content. See *DataWedge on page 3-15* for information on enabling **DataWedge**.

1. Launch a scanning application.
2. Point the exit window at a bar code.



**Figure 3-2** *Laser Scanning*

3. Press the trigger button. Ensure the red scan beam covers the entire bar code. The Charging/Scan LED Indicators illuminate green and a beep sounds to indicate a successful decode.



**Figure 3-3** *Laser Aiming*

4. Release the trigger or scan button.

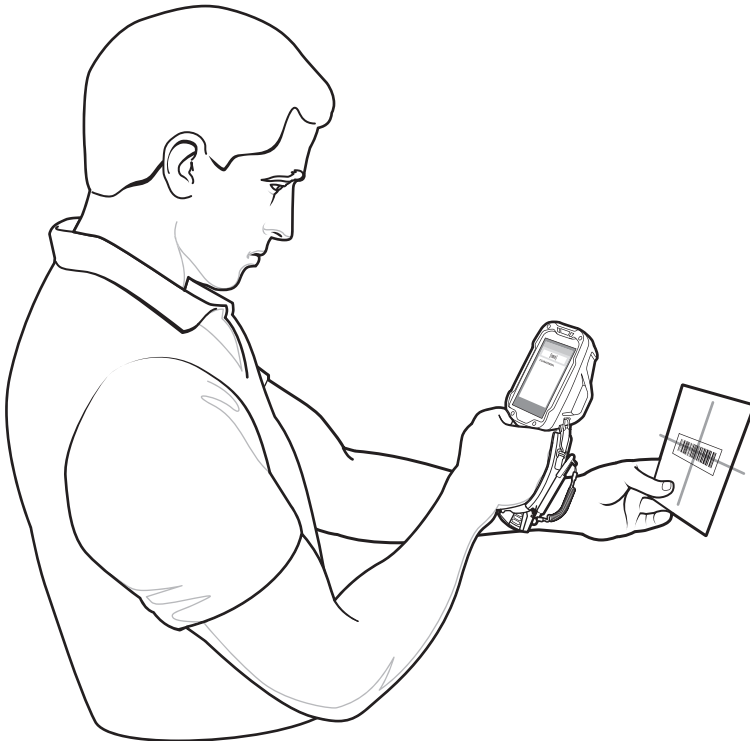
---

## Bar Code Capture with Imager

To read a bar code, a scan-enabled application is required. The TC8000 contains the **DataWedge** application that allows the user to enable the scanner to decode bar code data and display the bar code content. See *DataWedge on page 15* for more information on launching DataWedge.

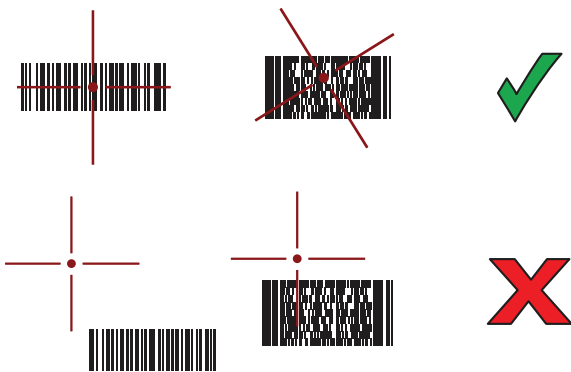
1. Launch a scanning application.
2. Point the exit window at a bar code.

3. Press the trigger button.

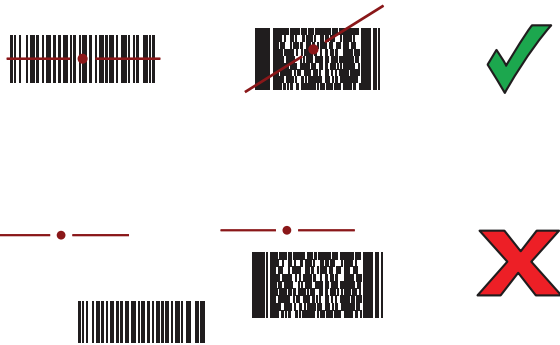


**Figure 3-4** *Imager Scanning*

4. Ensure the red scan beam covers the entire bar code. The Charging/Scan LED Indicators illuminate green and a beep sounds to indicate a successful decode.



**Figure 3-5** *Imager Aiming Pattern - Standard Range*



**Figure 3-6** *Imager Aiming Pattern - Extended Range*



**Figure 3-7** *Imager Pick List Mode with Multiple Bar Codes - Standard Range*



**Figure 3-8** *Imager Pick List Mode with Multiple Bar Codes - Extended Range*

5. Release the trigger.

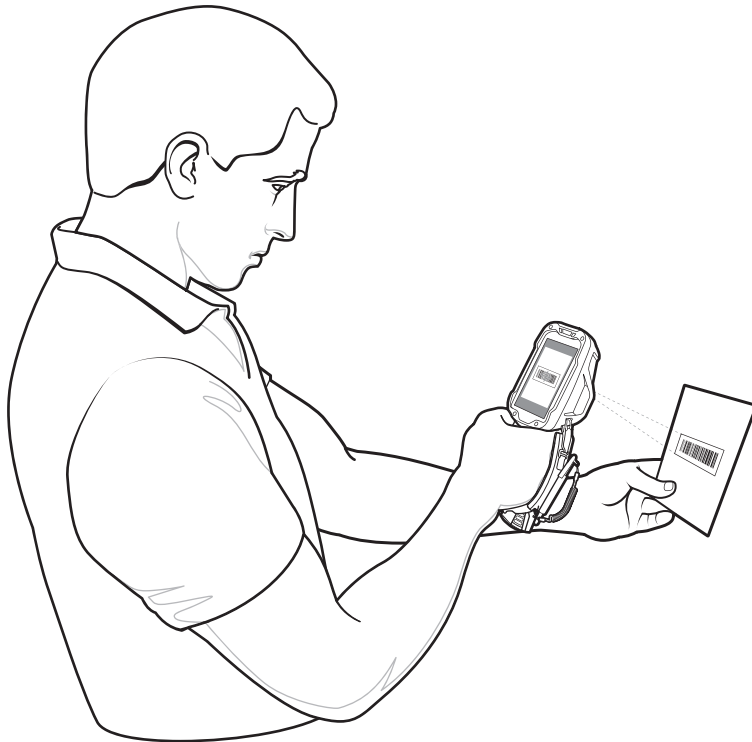
---

## Bar Code Capture with Camera

To read a bar code, a scan-enabled application is required. The TC8000 contains the **DataWedge** application that allows the user to enable the scanner to decode bar code data and display the bar code content. See *DataWedge* on page 3-15 for more information on launching DataWedge.

1. Launch a scanning application.
2. Point the camera window at a bar code.
3. Press and hold the trigger. By default, a preview window appears on the screen.





**Figure 3-9** Camera Scanning

✓ **NOTE** When Picklist mode is enabled, move the TC8000 until the bar code is centered under the red target on the screen.

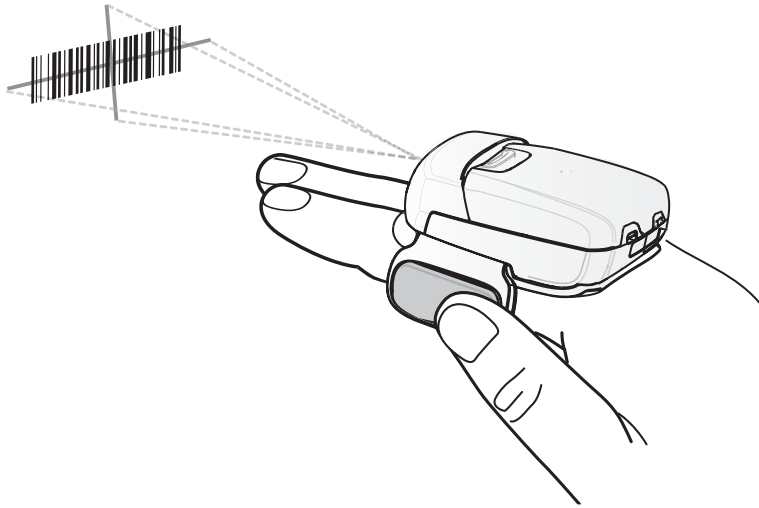
4. Move the TC8000 until the bar code is visible on the screen.
5. The Decode LED lights green, a beep sounds and the device vibrates, by default, to indicate the bar code was decoded successfully.
6. The captured data appears in the text field.
7. Release the trigger.

---

## Bar Code Capture with RS507 Hands-Free Imager

Pair the RS507 with the TC8000. See *Pairing the RS507 Hands-Free Imager Using SSI on page 3-9* or *Pairing the RS507 Hands-Free Imager Using Bluetooth HID on page 3-9* for more information.

1. Ensure that an application is open on the device and a text field is in focus (text cursor in text field).
2. Point the RS507 at a bar code.

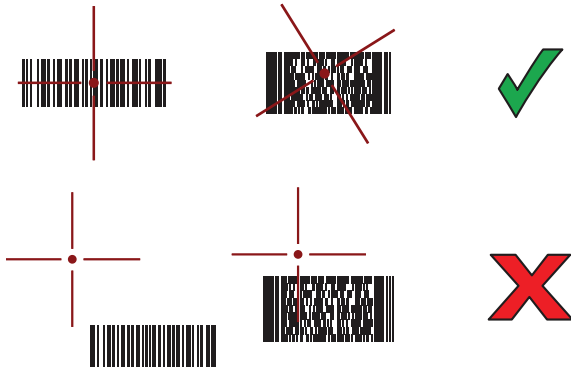


**Figure 3-10** Bar Code Scanning with RS507

3. Press and hold the trigger.

The red laser aiming pattern turns on to assist in aiming. Ensure the bar code is within the area formed by the cross-hairs in the aiming pattern. The aiming dot is used for increased visibility in bright lighting conditions.

The RS507 LEDs light green, a beep sounds to indicate the bar code was decoded successfully. Note that when the RS507 is in Pick List Mode, the RS507 does not decode the bar code until the center of the crosshair touches the bar code.



**Figure 3-11** Aiming Pattern





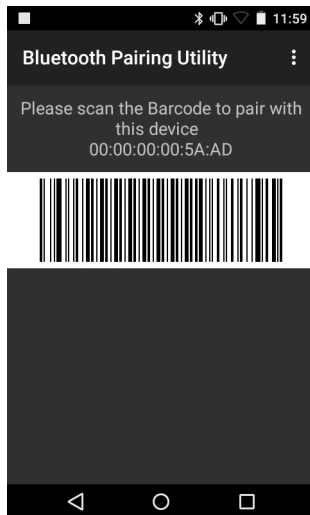
**Figure 3-12** Pick List Mode with Multiple Bar Codes in Aiming Pattern

4. The captured data appears in the text field.

## Pairing the RS507 Hands-Free Imager Using SSI


An RS507 Hands-free Imager can be used with the device to capture bar code data.

1. Ensure that the two devices are within 10 meters (32.8 feet) of one another.
2. Install the battery into the RS507.
3. On the TC8000, touch  > .



**Figure 3-13** Bluetooth Pairing Utility

4. Using the RS507, scan the bar code on the screen.
 

The RS507 emits a high/low/high/low beeps. The Scan LED flashes green indicating that the RS507 is attempting to establish connection with the TC8000. When connection is established, the Scan LED turns off and the RS507 emits one string of low/high beeps.
5. On the TC8000, touch .

## Pairing the RS507 Hands-Free Imager Using Bluetooth HID




An RS507 Hands-free Imager can be used with the device to capture bar code data.

1. Ensure that Bluetooth is enabled on both devices.
2. Ensure that the Bluetooth device to discover is in discoverable mode.
3. Ensure that the two devices are within 10 meters (32.8 feet) of one another.
4. Place the RS507 in Human Interface Device (HID) mode. If the RS507 is already in HID mode, skip to step 5.
  - a. Remove the battery from the RS507.
  - b. Press and hold the Restore key.
  - c. Install the battery onto the RS507.
  - d. Keep holding the Restore key for about five seconds until a chirp is heard and the Scan LEDs flash green.

- e. Scan the bar code below to place the RS507 in HID mode.



**Figure 3-14** *RS507 Bluetooth HID Bar Code*

5. Remove the battery from the RS507.
6. Re-install the battery into the RS507.
7. Touch  >  >  **Bluetooth**.
8. Touch **SCAN FOR DEVICES**. The device begins searching for discoverable Bluetooth devices in the area and displays them under **AVAILABLE DEVICES**.
9. Scroll through the list and select RS507.

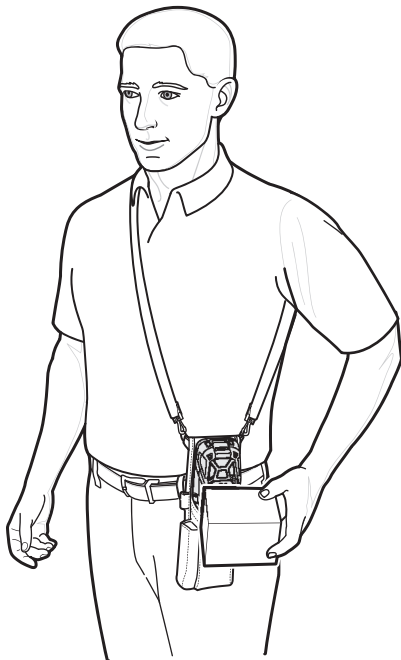
The device connects to the RS507 and **Connected** appears below the device name. The Bluetooth device is added to the **Bluetooth devices** list and a trusted (“paired”) connection is established.

---

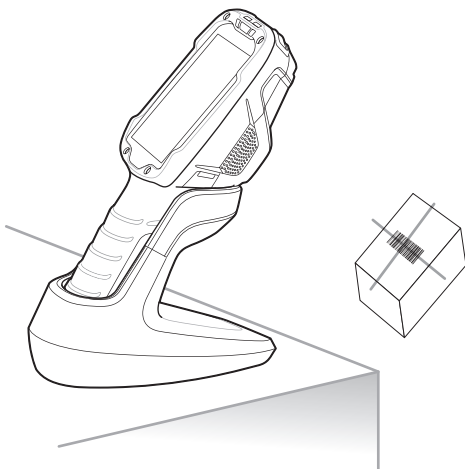
## Hands Free Scanning

✓ **NOTE** The Hands Free Scanning is only available on devices with the imager engine.

Hands Free Scanning allows the user to capture bar code data when a bar code is placed within the view of the device without pressing the trigger. Hands Free Scanning is enabled using the **Hands Free Scanning** settings or when the device is placed in the Presentation Holster or the Desk Stand. Hands Free Scanning is set to disabled by default.



**Figure 3-15** *Scanning in Presentation Holster*



**Figure 3-16** *Scanning in Desk Stand*

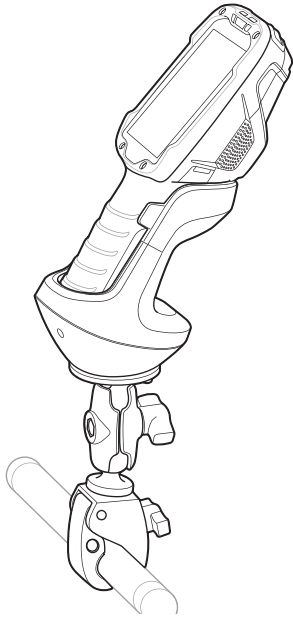


Figure 3-17 Scanning in Cart Mount

## Settings

Use the **Hands Free Scanning** setting to configure scanning mode and the proximity trigger sensitivity.

Touch  >  > **Hands Free Scanning**.

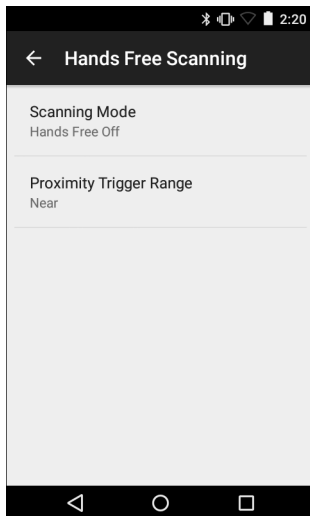
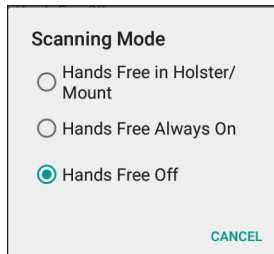


Figure 3-18 Hands Free Scanning Settings

## Scanning Mode

Use the **Scanning Mode** settings to configure how the TC8000 functions while in hands-free scanning mode.

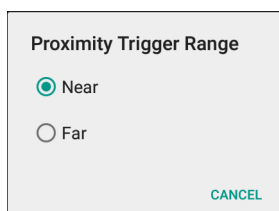


**Figure 3-19** *Scanning Mode Dialog Box*

- **Hands Free in Holster/Mount** - Select to enable scanning when the TC8000 is in the Presentation Holster, Desk Stand or Cart Mount.
- **Hands Free Always On** - Select to place the device in hands free scanning mode.
- **Hands Free Off** - Select to disable hands free scanning mode (default).

## Proximity Range

To configure the proximity sensor range sensitivity, touch **Proximity Trigger Range**.

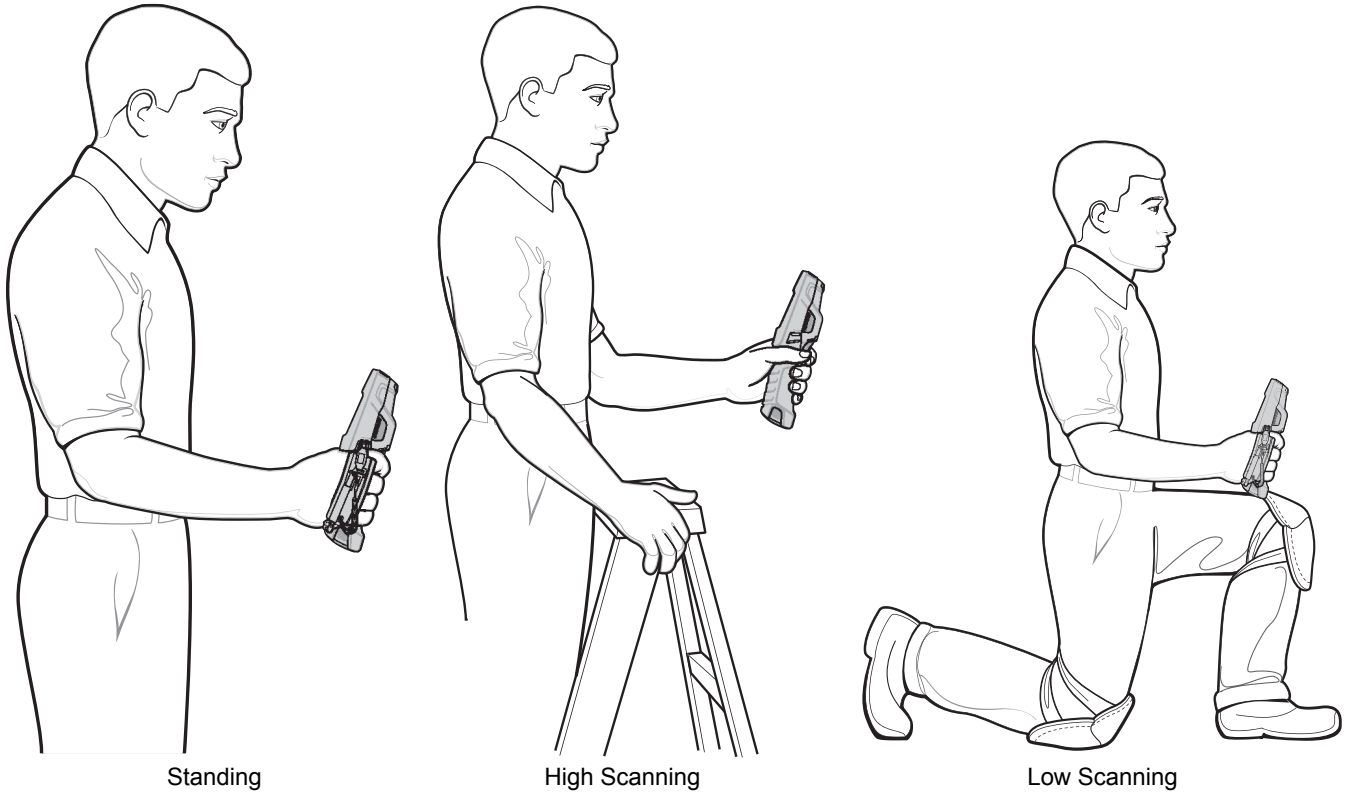


**Figure 3-20** *Proximity Trigger Range Dialog Box*

- **Near** - Proximity sensor detects and generates a trigger when the bar code is within 0 to 20 cm (nominal) (default).
- **Far** - Proximity sensor detects and generates a trigger when the bar code is within 0 to 60 cm (nominal).

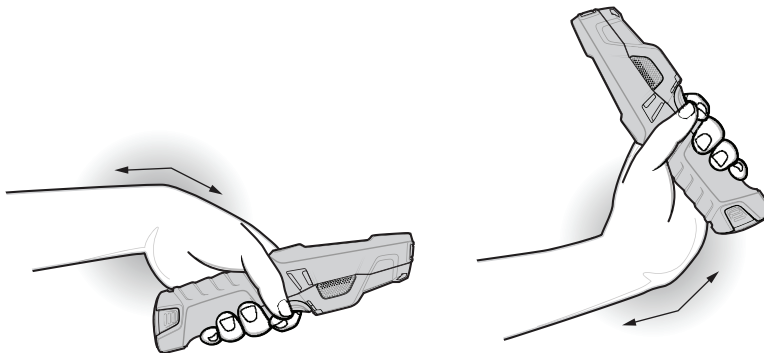
## Ergonomic Recommendations

### Proper Scanning



**Figure 3-21** *Proper Scanning Position*

### Avoid



**Figure 3-22** *Do Not Bend Wrist Excessively*



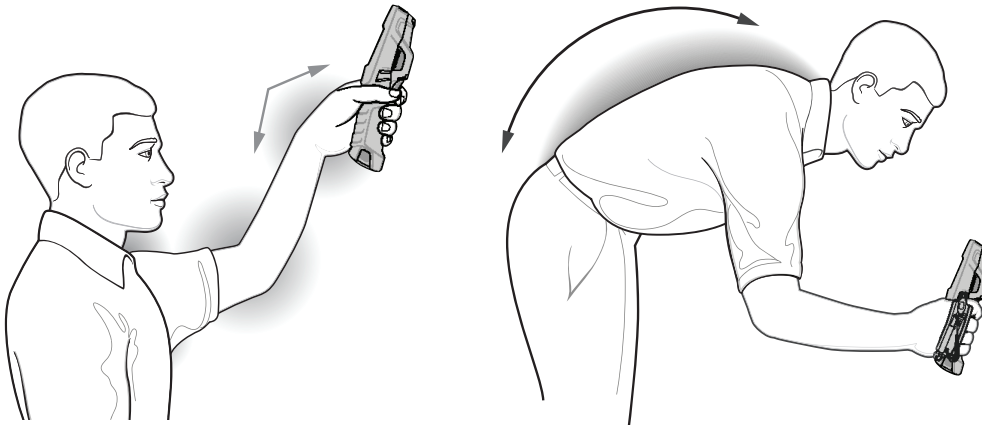


Figure 3-23 Reaching and Bending





## DataWedge



**NOTE** DataWedge is enabled by default. Refer to the *TC8000 Integrator Guide* for DataWedge configuration.





### Enable DataWedge

To enable DataWedge:

1. Touch  >  >  .
2. Touch **Settings**.
3. Touch the **DataWedge enabled** checkbox. A blue checkmark appears in the checkbox indicating that DataWedge is enabled.
4. Touch  .

### Disable DataWedge

To disable DataWedge:

1. Touch  >  >  .
2. Touch **Settings**.
3. Touch the **DataWedge enabled** checkbox. The blue checkmark disappears from the checkbox indicating that DataWedge is disabled.
4. Touch  .



# CHAPTER 4 WIRELESS

---

## Wireless Local Area Networks

Wireless local area networks (WLANs) allow the TC8000 to communicate wirelessly inside a building. Before using the TC8000 on a WLAN, the facility must be set up with the required hardware to run the WLAN (sometimes known as infrastructure). The infrastructure and the TC8000 must both be properly configured to enable this communication.

Refer to the documentation provided with the infrastructure (access points (APs), access ports, switches, Radius servers, etc.) for instructions on how to set up the infrastructure.

Once the infrastructure is set up to enforce the chosen WLAN security scheme, use the **Wireless & networks** settings to configure the TC8000 to match the security scheme.

The TC8000 supports the following WLAN security options:

- Open
- Wireless Equivalent Privacy (WEP).
- Wi-Fi Protected Access (WPA/WPA2) Personal (PSK).
- Extensible Authentication Protocol (EAP).
  - Protected Extensible Authentication Protocol (PEAP) - with MSCHAPV2 and GTC authentication.
  - Transport Layer Security (TLS)
  - TTLS - with Password Authentication Protocol (PAP), MSCHAP and MSCHAPv2 authentication.
  - LEAP
  - FAST - with MSCHAPV2 and GTC authentication.

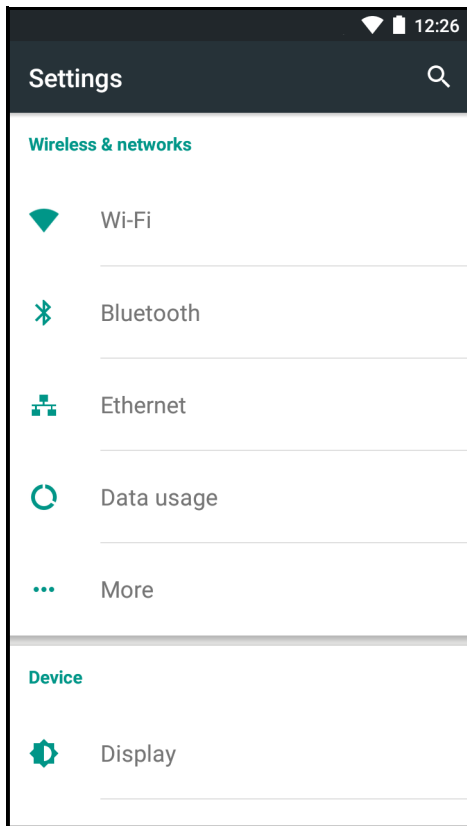
The **Status** bar displays icons that indicate Wi-Fi network availability and Wi-Fi status. See *Status Bar on page 2-3* for more information.



**NOTE** Turn off Wi-Fi when not using it, to extend the life of the battery.

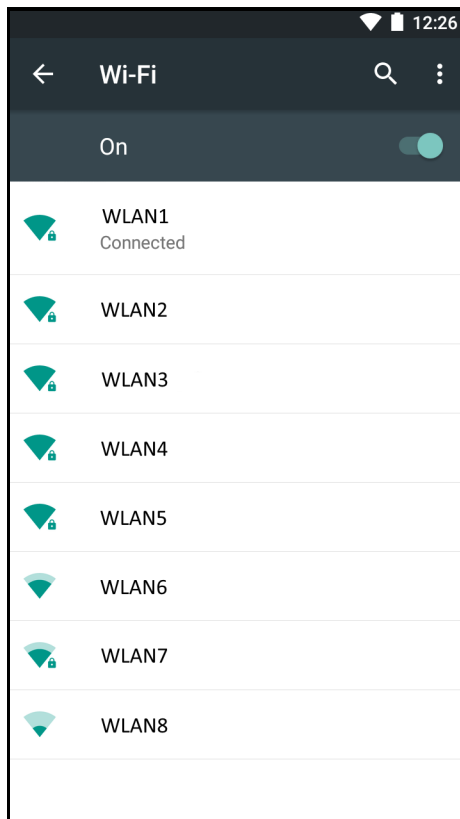
## Scan and Connect to a Wi-Fi Network

1. Touch  >  >  **Wi-Fi**.



**Figure 4-1** Settings Screen

2. Slide the **Wi-Fi** switch to the **ON** position. The TC8000 searches for WLANs in the area and lists them.



**Figure 4-2** *Wi-Fi Screen*




3. Scroll through the list and select the desired WLAN network.
4. For open networks, touch profile once or press and hold and then select **Connect to network** or for secure networks enter the required password or other credentials then touch **Connect**. See the system administrator for more information.

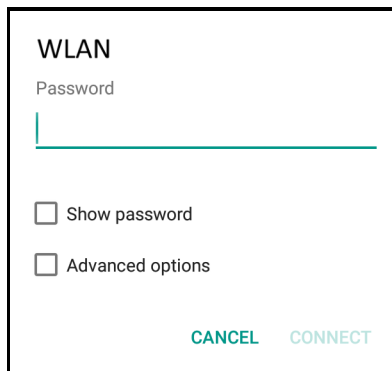
The TC8000 obtains a network address and other required information from the network using the dynamic host configuration protocol (DHCP) protocol. To configure the TC8000 with a fixed internet protocol (IP) address, See *Configuring the Device to Use a Static IP Address on page 4-7*.

5. In the Wi-Fi status field, **Connected** appears indicating that the TC8000 is connected to the WLAN.

## Configuring a Wi-Fi Network

To set up a Wi-Fi network:

1. Touch  >  >  **Wi-Fi**.
2. Slide the switch to the **ON** position. The device searches for WLANs in the area and lists them on the screen.
3. Scroll through the list and select the desired WLAN network.
4. Touch the desired network. If the network security is **Open**, the device automatically connects to the network. For all other network security a dialog box appears.



**WLAN**

Password

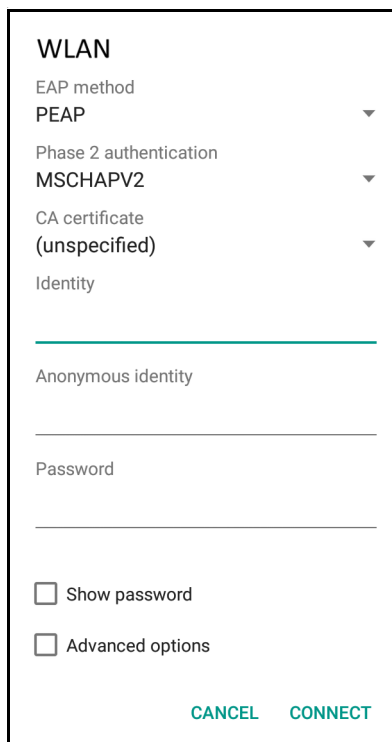
Show password

Advanced options

**CANCEL** **CONNECT**

**Figure 4-3** WLAN Network Security Dialog Box

5. If the network security is **WEP** or **WPA/WPS2 PSK**, enter the required password and then touch **Connect**



**WLAN**

EAP method  
PEAP ▼

Phase 2 authentication  
MSCHAPV2 ▼

CA certificate  
(unspecified) ▼

Identity

Anonymous identity

Password

Show password

Advanced options

**CANCEL** **CONNECT**

**Figure 4-4** 802.1x EAP Security Dialog Box

6. If the network security is 802.1x EAP:
  - a. Touch the EAP method drop-down list and select **PEAP**, **TLS**, **TTLS**, **LEAP** or **FAST**.
  - b. Touch the **Phase 2 authentication** drop-down list and select an authentication method.
  - c. If required, touch **CA certificate** and select a Certification Authority (CA) certificate. Note: Certificates are installed using the **Security** settings.
  - d. If required, touch **User certificate** and select a user certificate. Note: User certificates are installed using the Location & security settings.
  - e. If required, in the **Identity** text box, enter the username credentials.
  - f. If desired, in the **Anonymous identity** text box, enter an anonymous identity username.
  - g. If required, in the **Password** text box, enter the password for then given identity.






- ✓ **NOTE** By default, the network Proxy is set to None and the IP settings is set to DHCP. See *Configuring for a Proxy Server on page 4-6* for setting connection to a proxy server and see *Configuring the Device to Use a Static IP Address on page 4-7* for setting the device to use a static IP address.

7. Touch **Connect**.

8. Touch .

## Manually Adding a Wi-Fi Network





Manually add a Wi-Fi network if the network does not broadcast its name (SSID) or to add a Wi-Fi network when out of range.

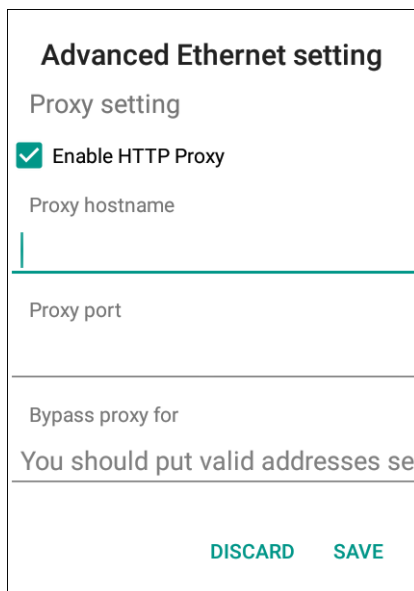
1. Touch  >  >  **Wi-Fi**.
  2. Slide the Wi-Fi switch to the **On** position.
  3. Touch  > **Add network**.
  4. In the **Network SSID** text box, enter the name of the Wi-Fi network.
  5. In the **Security** drop-down list, select the type of security. Options:
    - **None**
    - **WEP**
    - **WPA/WPA2 PSK**
    - **802.1x EAP**.
  6. If the network security is **None**, touch **Save**.
  7. If the network security is **WEP** or **WPA/WPA2 PSK**, enter the required password and then touch **Save**.
  8. If the network security is **802.1x EAP**:
    - Touch the **EAP method** drop-down list and select **PEAP**, **TLS**, **TTLS**, **LEAP** or **FAST**.
    - Touch the **Phase 2 authentication** drop-down list and select an authentication method.
    - If required, touch **CA certificate** and select a Certification Authority (CA) certificate. Note: Certificates are installed using the **Security** settings.
    - If required, touch **User certificate** and select a user certificate. Note: User certificates are installed using the **Security** settings.
    - If required, in the **Identity** text box, enter the username credentials.
    - If desired, in the **Anonymous identity** text box, enter an anonymous identity username.
    - If required, in the **Password** text box, enter the password for then given identity.
- ✓ **NOTE** By default, the network Proxy is set to **None** and the IP settings is set to **DHCP**. See *Configuring for a Proxy Server on page 4-6* for setting connection to a proxy server and see *Configuring the Device to Use a Static IP Address on page 4-7* for setting the device to use a static IP address.
9. Touch **Save**. To connect to the saved network, touch and hold on the saved network and select **Connect to network**.
  10. Touch .

## Configuring for a Proxy Server

A proxy server is a server that acts as an intermediary for requests from clients seeking resources from other servers. A client connects to the proxy server, requesting some service, such as a file, connection, web page, or other resource, available from a different server. The proxy server evaluates the request according to its filtering rules. For example, it may filter traffic by IP address or protocol. If the request is validated by the filter, the proxy provides the resource by connecting to the relevant server and requesting the service on behalf of the client.

It is important for enterprise customers to be able to set up secure computing environments within their companies, and proxy configuration is an essential part of doing that. Proxy configuration acts as a security barrier ensuring that the proxy server monitors all traffic between the Internet and the intranet. This is normally an integral part of security enforcement in corporate firewalls within intranets.


1. Touch  >  >  **Ethernet**.
2. Slide the switch to the **ON** position.
3. Touch  > **Advanced**.



**Figure 4-5** Ethernet Proxy Settings

4. Touch **Enable HTTP Proxy**.
5. In the **Proxy hostname** field, enter the proxy server address.
6. In the **Proxy port** field, enter the proxy server port number.





✓ **NOTE** When entering proxy addresses in the **Bypass proxy for** field, do not use spaces or carriage returns between addresses.

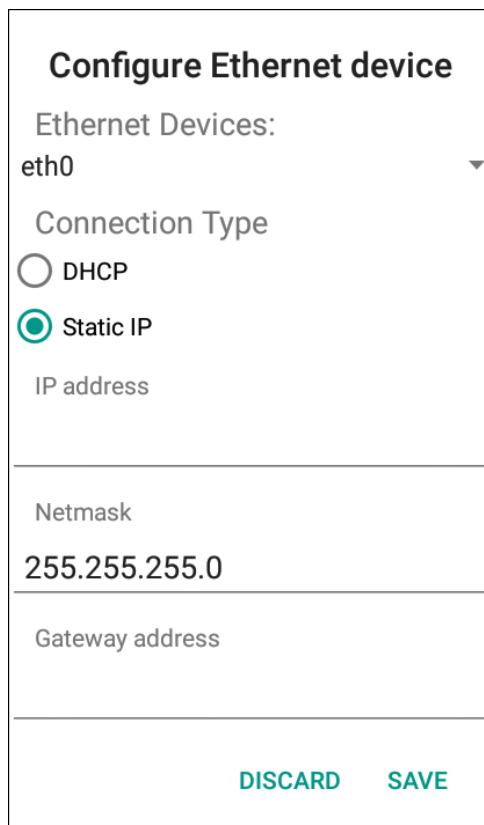
7. In the **Bypass proxy for** text box, enter addresses for web sites that do not require to go through the proxy server. Use the separator “|” between addresses.
8. Touch **Save**.
9. Touch .



## Configuring the Device to Use a Static IP Address

By default, the device is configured to use Dynamic Host Configuration Protocol (DHCP) to assign an Internet protocol (IP) address when connecting to a wireless network. To configure the device to connect to a network using a static IP address:

1. Touch  >  >  **Ethernet**.
2. Slide the switch to the **ON** position.
3. Touch  **Config**.



**Configure Ethernet device**

Ethernet Devices:  
eth0

Connection Type

DHCP

**Static IP**

IP address

---

Netmask  
255.255.255.0


---

Gateway address

---


**DISCARD** **SAVE**

**Figure 4-6** *Configure Ethernet Device Settings*

4. Under **Connection Type**, touch the **Static IP** radio button.  
**DHCP** is the default **Connection Type**.
5. In the **IP address** field, enter the proxy server address.
6. If required, in the **Netmask** text box, enter the network mask address.
7. If required, in the **Gateway address** text box, enter a gateway address for the device.
8. If required, in the **DNS 1 address** text box, enter a Domain Name System (DNS) address.
9. Touch **Save**.
10. Touch .

## Advanced Wi-Fi Settings

✓ **NOTE** Advanced Wi-Fi settings are for the device not for a specific wireless network.

Use the **Advanced** option to configure advanced Wi-Fi settings. Touch  > **Advanced** to view the advanced settings.

- **Network notification** - When enabled, notifies the user when an open network is available.
- **Scanning always available** - Let Google's location service and other apps scan for networks, even when Wi-Fi is off.
- **Keep Wi-Fi on during sleep** - Opens a menu to set whether and when the Wi-Fi radio turns off.
  - **Always** - The radio stays on when the device enters suspend mode.
  - **Only when plugged in** - The radio stays on while the device is connected to external power.
  - **Never** - The radio turns off when the device enters suspend mode (default).
- **Wi-Fi frequency band** - Use to select the frequency band. Options: **Automatic** (default), **5 GHz only** or **2.4 GHz only**.
- **Install Certificates** – Touch to install certificates.
- **Wi-Fi Direct** – Displays a list of devices available for a direct Wi-Fi connection.
- **WPS Push Button**– Touch to connect to a network using Wi-Fi Protected Setup (WPS) push button method.
- **WPS Pin Entry** – Touch to connect to a network using Wi-Fi Protected Setup (WPS) pin entry method.
- **MAC address** - Displays the Media Access Control (MAC) address of the device when connecting to Wi-Fi networks.
- **IP address** - Displays the Internet Protocol (IP) address of the device when connecting to Wi-Fi networks.

### Wi-Fi Direct

Wi-Fi Direct devices can connect to each other without having to go through an access point. Wi-Fi Direct devices establish their own ad-hoc network when required, letting you see which devices are available and choose which one you want to connect to.

1. Touch  >  >  **Wi-Fi** >  > **Advanced** > **Wi-Fi Direct**. The TC8000 begins searching for another Wi-Fi Direct device.

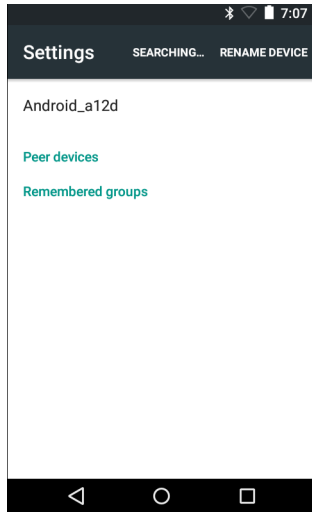






Figure 4-7 Wi-Fi Direct Screen

2. Under **Peer devices**, touch the other device name.
3. On the other device, select **Accept**.
4. Connected appears on the TC8000. On both devices, in their respective Wi-Fi Direct screens, the other device name appears in the list.

## WPS Pin Entry

Wi-Fi Protected Setup (WPS) is a feature allowing devices to easily connect to Wi-Fi access points without typing a long password.

To use a PIN to connect to a wireless router:

1. Log in to the router.
2. Go to the Add WPS Client screen. Refer to the wireless router user documentation specific information.
3. On the TC8000, touch  >  >  **Wi-Fi** >  > **Advanced** > **WPS Pin Entry**. A dialog box displays with an Pin number.

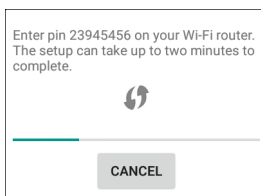



Figure 4-8 Pin Entry Dialog Box

4. On the router, enter the Pin number. The TC8000 connects to the wireless router.

---

## Additional Wi-Fi Settings

✓ **NOTE** Additional Wi-Fi settings are for the device not for a specific wireless network.

Use the **Additional Settings** option to configure additional Wi-Fi settings. Touch  > **Additional Settings** to view the additional settings.

- **Regulatory**

- **Country selection** - Allows user to select the country of operation. If **Auto** is selected, the TC8000 will acquire the country information from the Access Points and displays the acquired country name.
- **Region code** - Displays the current region code.

- **Band and Channel Selection**

- **Wi-Fi frequency band** - Use to select the frequency band. Options: **Automatic** (default), **5 GHz only** or **2.4 GHz only**.
- **Available channels (2.4 GHz)** - Use to select specific channels. Touch to display the **Available channels** menu. Select specific channels. Touch **OK**.
- **Available channels (5 GHz)** - Use to select specific channels. Touch to display the **Available channels** menu. Select specific channels. Touch **OK**.

- **Logging**

- **Advanced Logging** - Provides support for continuous capture of system logs to a file to help in debugging and resolution of Wi-Fi related issues. Disabled by default. In the **Advanced Logging** dialog box, select **Enable logging**. If desired, change the log directory location. When enabled, the following logs are captured:

✓ **NOTE** All log files are saved in /storage/sdcard/fusionlogs on the TC8000.

Fusion will ask the user whether to clear out previous logs before starting logging.

tcpdump capture file and fusion-sysinfo.log will only be generated when advanced logging is stopped.

- Android logcat output with time stamps and the kernel messages in the file: *fusion-wlan.log*.
- tcpdump intermediate capture of packets between network stack and driver in the file: *fusion-pktcap.pcap*
- Fusion versions, Wi-Fi state machine logs and other framework information in the file: *fusion-sysinfo.log*.
- **Wireless logs** - Use to capture Wi-Fi log files.
  - **Fusion Logger** - Touch to open the **Fusion Logger** application. This application maintains a history of high level WLAN events which helps to understand the status of connectivity.
  - **Fusion Status** - Touch to display live status of WLAN state. Also provides information of device and connected profile.

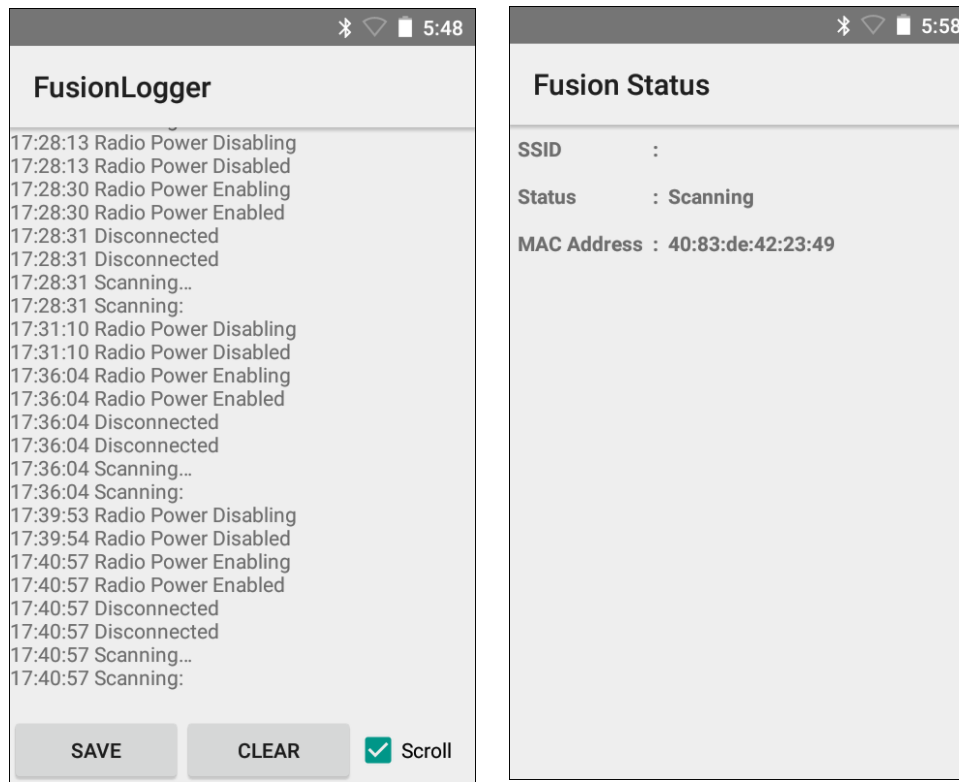


Figure 4-9 Fusion Logger Screen and Fusion Logger Status Screen

- **About**
  - **Version** - Displays the current Fusion information.

## Additional Wi-Fi Advanced Features

Some additional Wi-Fi settings cannot be accessed from the User Interface. They can be configured by using Wi-Fi (CSP). Refer to EMDK documentation for the details on the Wi-Fi settings configuration using the Wi-Fi CSP.

- **Auto Time Config** - Using this feature, the device can sync up its time with Zebra WLAN infrastructure. This feature works only when the device is connected to Zebra WLAN infrastructure and the feature is enabled on the WLAN infrastructure side. Default: disabled.
- **PMKID Caching** - Allows the device to skip 802.1x authentication during roaming if it had previously connected to that AP with a full 802.1x authentication. Default: disabled. Note: disable OKC when enabling PMKID Caching.
- **Opportunistic Key Caching** - Use this feature to skip 802.1x authentication during roaming. The device will go for full 802.1x authentication for the first time it connects to the network. For subsequent roaming, the device skips 802.1x authentication. Default: enabled.
- **Cisco Centralized Key Management** - Allows the device to skip 802.1x and key-handshake phases during roaming. This feature is available only when the device is connected to a Cisco infrastructure that supports Cisco Centralized Key Management (CCKM). Default: enabled.
- **Fast Transition** - Fast Transition (FT) is the fast roaming standard, 802.11r. With this feature, the device can skip 802.1x and key-handshake phases during roam. Default: enabled.

- **Fast Transition Resource Information Container** - Allows the device to request TSPEC as part of reassociation frame exchange. This helps to avoid sending a separate resource request after roaming is completed. Default: disabled.
- **Power Save** - The device can be configured to work in different power save modes:
  - **Active** - Keeps the WLAN radio always in active mode (i.e. power save mode disabled).
  - **Power save using WMM-PS** - This is the default power save mode. Device uses WMM-PS power save method if the AP is configured to use this. If the AP is not supporting WMM-PS, the device will use PS-Poll power save method.
  - **Power save using PS-Poll** - In this method, the device will use PS-Poll frames to retrieve buffered frames from the AP.
  - **Null Data Power Save** - In Null Data Power Save (NDP), the device will stay awake for 100 ms after the last frame is sent or received. The device will send a Null Data packet with power management bit cleared to retrieve buffered frames from the AP.
- **802.11k** - Using 802.11k, the device can discover neighbor APs and adds support for different types of radio resource measurements. Default: enabled.
- **Band Preference** - The device can be configured to prefer one band over another. By default, device prefers 5 GHz frequency band over 2.4 GHz.
- **Subnet Roaming** - When the device roams between different sub networks, if it detects that it is roaming to a different subnet, the device will request a fresh IP address. Default: disabled.

---

## Zebra Mobility Extensions




Zebra Mobility Extensions make use 802.11 specifications and Zebra proprietary extensions to achieve the highest level of performance, efficiency and reliability. The TC8000 adds support for the following Zebra Mobility Extensions.


- **Coverage Hole Detection** - The TC8000 includes enhancements to the IEEE 802.11k standard. These improvements will report gaps in signal coverage to the Zebra wireless LAN infrastructure. Network administrators can detect and mitigate coverage gaps present in the network for greater reliability. Default: enabled.
- **Aggregated Fast Transition** - Aggregated FT improves on IEEE 802.11r, Over-the-DS fast roaming. In conjunction with Zebra wireless LAN infrastructure, the TC8000 will achieve more reliable and consistent fast roaming. Default: enabled.
- **Scan Assist** - The TC8000 monitors neighbor access points and retrieves roaming related information from the Zebra wireless LAN infrastructure without doing scans. Using this Scan Assist feature, the TC8000 improves roaming. Default: enabled.

---

## Remove a Wi-Fi Network

To remove a remembered or connected network:

1. Touch  >  >  **Wi-Fi**.
2. In the **Wi-Fi networks** list, touch and hold the name of the network.

3. In the menu, touch **Forget network**.
4. Touch .

---

## Bluetooth

Bluetooth-equipped devices can communicate without wires, using frequency-hopping spread spectrum (FHSS) radio frequency (RF) to transmit and receive data in the 2.4 GHz Industry Scientific and Medical (ISM) band (802.15.1). Bluetooth wireless technology is specifically designed for short-range (10 meters (32.8 feet)) communication and low power consumption.

Devices with Bluetooth capabilities can exchange information (e.g., files, appointments, and tasks) with other Bluetooth enabled devices such as printers, access points, and other mobile devices.

### Adaptive Frequency Hopping

Adaptive Frequency Hopping (AFH) is a method of avoiding fixed frequency interferers, and can be used with Bluetooth voice. All devices in the piconet (Bluetooth network) must be AFH-capable in order for AFH to work. There is no AFH when connecting and discovering devices. Avoid making Bluetooth connections and discoveries during critical 802.11b communications. AFH for Bluetooth consists of four main sections:

- **Channel Classification** - A method of detecting an interference on a channel-by-channel basis, or pre-defined channel mask.
- **Link Management** - Coordinates and distributes the AFH information to the rest of the Bluetooth network.
- **Hop Sequence Modification** - Avoids interference by selectively reducing the number of hopping channels.
- **Channel Maintenance** - A method for periodically re-evaluating the channels.

When AFH is enabled, the Bluetooth radio “hops around” (instead of through) the 802.11b high-rate channels. AFH coexistence allows Enterprise devices to operate in any infrastructure.

The Bluetooth radio in this device operates as a Class 2 device power class. The maximum output power is 2.5 mW and the expected range is 10 meters (32.8 ft.). A definition of ranges based on power class is difficult to obtain due to power and device differences, and whether one measures open space or closed office space.

- ✓ **NOTE** It is not recommended to perform Bluetooth wireless technology inquiry when high rate 802.11b operation is required.

### Security

The current Bluetooth specification defines security at the link level. Application-level security is not specified. This allows application developers to define security mechanisms tailored to their specific need. Link-level security occurs between devices, not users, while application-level security can be implemented on a per-user basis. The Bluetooth specification defines security algorithms and procedures required to authenticate devices, and if needed, encrypt the data flowing on the link between the devices. Device authentication is a mandatory feature of Bluetooth while link encryption is optional.

Pairing of Bluetooth devices is accomplished by creating an initialization key used to authenticate the devices and create a link key for them. Entering a common personal identification number (PIN) in the devices being paired generates the initialization key. The PIN is never sent over the air. By default, the Bluetooth stack responds with no key when a key is requested (it is up to user to respond to the key request event). Authentication of Bluetooth devices is based-upon a challenge-response transaction. Bluetooth allows for a PIN or passkey used to create

other 128-bit keys used for security and encryption. The encryption key is derived from the link key used to authenticate the pairing devices. Also worthy of note is the limited range and fast frequency hopping of the Bluetooth radios that makes long-distance eavesdropping difficult.

Recommendations are:

- Perform pairing in a secure environment
- Keep PIN codes private and do not store the PIN codes in the device
- Implement application-level security.

### Bluetooth Profiles

The device supports the following Bluetooth services:

- **Service Discovery Protocol (SDP)** - Handles the search for known and specific services as well as general services.
- **Serial Port Profile (SPP)** - Allows use of RFCOMM protocol to emulate serial cable connection between two Bluetooth peer devices. For example, connecting the device to a printer.
- **Advanced Audio Distribution Profile (A2DP)** - Allows the device to stream stereo-quality audio to a wireless headset or wireless stereo speakers.
- **Audio/Video Remote Control Profile (AVRCP)** - Allows the device to control A/V equipment to which a user has access. It may be used in concert with A2DP.
- **Human Interface Device Profile (HID)** - Allows Bluetooth keyboards, pointing devices, gaming devices and remote monitoring devices to connect to the device.
- **Object Push Profile (OPP)** - Allows the device to push and pull objects to and from a push server.
- **Headset Profile (HSP)** - Allows a hands-free device, such as a Bluetooth headset, to place and receive calls on the device.
- **Hands-Free Profile (HFP)** - Allows car hands-free kits to communicate with the device in the car.
- **Personal Area Network (PAN)** - Allows the use of Bluetooth Network Encapsulation Protocol to provide L3 networking capabilities over a Bluetooth link. Only PANU role is supported.
- **Out of Band (OOB)** - Allows exchange of information used in the pairing process. Pairing is completed using the Bluetooth radio, but requires information from the OOB mechanism. Using OOB with NFC enables pairing when devices simply get close, rather than requiring a lengthy discovery process.

### Bluetooth Power States

The Bluetooth radio is off by default.

- **Suspend** - When the TC8000 goes into suspend mode, the Bluetooth radio stays on.
- **Airplane Mode** - When the TC8000 is placed in Airplane Mode, the Bluetooth radio turns off. When Airplane mode is disabled, the Bluetooth radio returns to the prior state. When in Airplane Mode, the Bluetooth radio can be turned back on if desired.







## Bluetooth Radio Power





Turn off the Bluetooth radio to save power or if entering an area with radio restrictions (e.g., an airplane). When the radio is off, other Bluetooth devices cannot see or connect to the device. Turn on the Bluetooth radio to exchange information with other Bluetooth devices (within range). Communicate only with Bluetooth radios in close proximity.

✓ **NOTE** To achieve the best battery life turn off radios when not in use.

### Enabling Bluetooth




1. Touch  >  >  **Bluetooth**.
2. Slide the Bluetooth switch to the **ON** position. The Bluetooth icon also appears in the Status bar.
3. Touch .

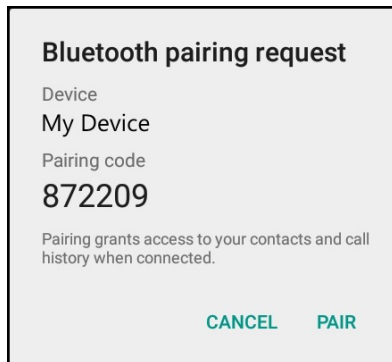
### Disabling Bluetooth

1. Touch  >  >  **Bluetooth**.
2. Slide the Bluetooth switch to the **OFF** position.
3. Touch .

## Discovering Bluetooth Device(s)

The TC8000 can receive information from discovered devices without pairing. However, once paired, the TC8000 and a paired device exchange information automatically when the Bluetooth radio is on. To find Bluetooth devices in the area:

1. Ensure that Bluetooth is enabled on both devices.
2. Ensure that the Bluetooth device to discover is in discoverable mode.
3. Ensure that the two devices are within 10 meters (32.8 feet) of one another.
4. Touch  >  >  **Bluetooth**.
5. If Bluetooth is off, slide the switch to the **ON** position.
6. The TC8000 begins searching for discoverable Bluetooth devices in the area and displays them under **Available Devices**.
7. Scroll through the list and select a device. The **Bluetooth pairing request** dialog box appears.








**Figure 4-10** Bluetooth Pairing — Smart Pairing

8. Enter a PIN in the text box and touch **OK**.
9. Enter the same PIN on the other device.
10. For Simple Pairing, touch **Pair** on both devices.
11. The Bluetooth device is added to the **Paired Devices** list and a trusted (“paired”) connection is established.




## Changing the Bluetooth Name

By default, the TC8000 has a generic Bluetooth name that is visible to other devices when connected.

1. Touch  >  >  **Bluetooth**.
2. If Bluetooth is not on, slide the switch to the **ON** position.
3. Touch .
4. Touch **Rename device**.
5. In the Rename device dialog box, enter a name and touch **Rename**.
6. Touch .

## Connecting to a Bluetooth Device



Once paired, connect to a Bluetooth device.

1. Touch  >  >  **Bluetooth**.
2. If Bluetooth is not on, slide the switch to the **ON** position.
3. In the **PAIRED DEVICES** list, touch and hold on a unconnected Bluetooth device until a menu appears.
4. Touch **Connect**. When connected, the device is displayed as connected in the list.

## Selecting Profiles on the Bluetooth Device






Some Bluetooth devices have multiple profiles. To select a profile:

1. Touch  >  >  **Bluetooth**.

2. In the **PAIRED DEVICES** list, touch  next to the device name.
3. Under **PROFILES**, check or uncheck a profile to allow the device to use that profile.
4. Touch .

## Unpairing a Bluetooth Device

To unpair a Bluetooth device and erase all pairing information:

1. Touch  >  >  **Bluetooth**.
2. In the **PAIRED DEVICES** list, touch  next to the device name.
3. Touch **Unpair**.
4. Touch .

---

## Near Field Communications

NFC/HF RFID is a short-range wireless connectivity technology standard that enables secure transaction between a reader and a contactless smart card. The technology is based on ISO/IEC 14443 type A and B (proximity), Felica and ISO/IEC 15693 (vicinity) standards, using the HF 13.56 MHz unlicensed band. The TC8000 supports three operating modes:

- Reader mode
- Peer-to-Peer communication
- Card Emulation mode.

Using NFC, the TC8000 can:

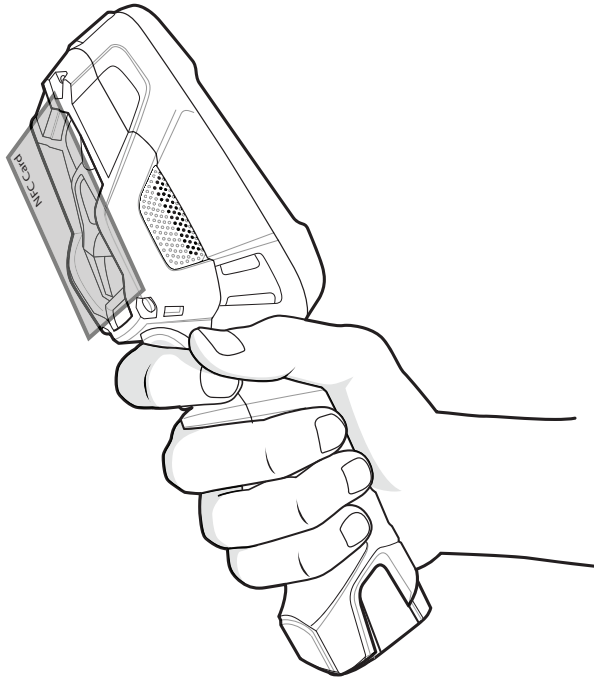
- Read contactless cards such as contactless tickets, NFC labels, HF tokens or standard smart cards.
- Read and write information to contactless cards such as SmartPosters and tickets, as well as devices with NFC interface such as vending machines.
- Read information from supported medical sensors.
- Pair with supported Bluetooth devices such as printers and headsets.
- Exchange data with another NFC device.
- Emulate contactless card such as ticket or V-card.

The TC8000 NFC antenna is uniquely positioned to read NFC cards from the back of the device while being held in the user's hand.

✓ **NOTE** NFC is enabled by default in TC8000 configurations with GMS.

## Reading NFC Cards

1. Launch an NFC enabled application.
2. Hold device as shown.



**Figure 4-11** *Reading NFC Card*

3. Move NFC card until the TC8000 detects the card.
4. Hold the card steadily until the transaction is complete (usually indicated by the application).

## Sharing Information Using NFC

You can beam content like a web page, contact cards, pictures, YouTube links or location information from the screen to another device by bringing the devices together back to back.

Make sure both devices are unlocked, support NFC, and have both NFC and Android Beam turned on.

1. Open a screen that contains a web page, video, photo or contact.
2. Move the back of the TC8000 toward the back of the other device.

When the devices connect, you hear a sound, the image on the screen reduces in size, the message **Touch to beam** appears.

3. Touch anywhere on the screen. The transfer begins.

## Enterprise NFC Settings

The Enterprise NFC Settings provides advanced configuration of the NFC radio.

To configure the NFC settings, touch **Settings** > **More...** > **Enterprise NFC Settings**.

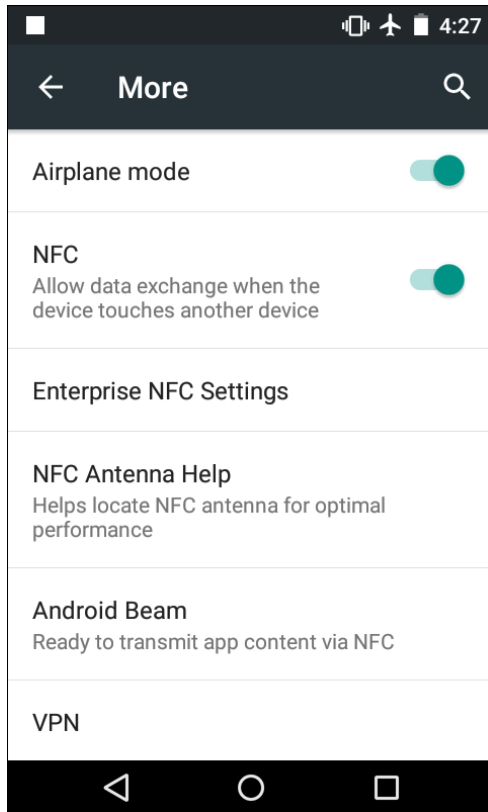
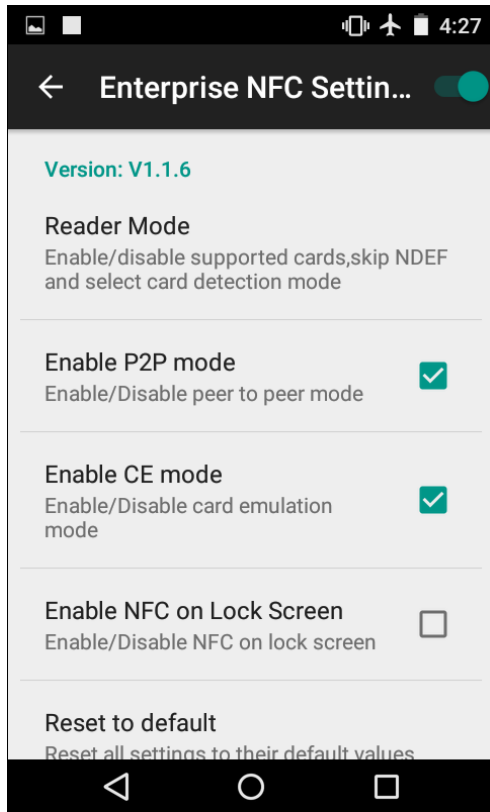


Figure 4-12 More Settings Screen

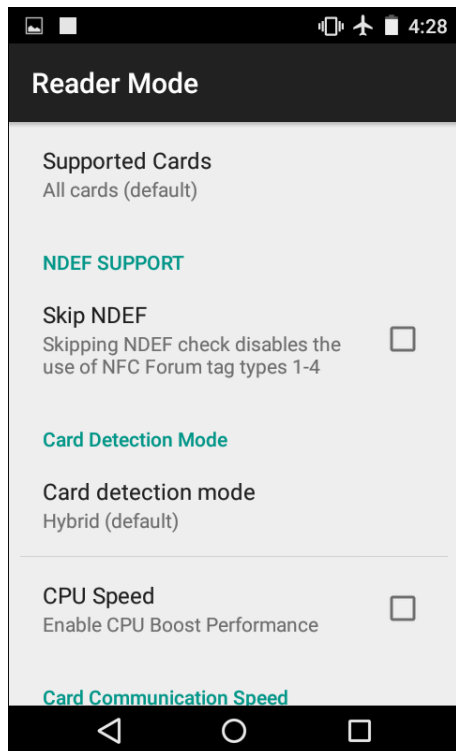


**Figure 4-13** Enterprise NFC Settings Screen

- **Reader Mode** – Touch to open the Reader Mode setting screen.
- **Enable P2P mode** – Enable or disable peer to peer mode. Default: Enabled.
- **Enable CE mode** – Touch to enable or disable card emulation mode. Default: Enabled.
- **Enable NFC on Lock Screen** – Enable or disable NFC on lock screen. Default: Disabled.
- **Reset to Default** – Reset all NFC settings to factory default settings.
- **Device NFC Config File Version** – Displays libnfc-nxp.config file version, version of Lib nfc and NFC controller FW version.

## Reader Mode

Use the **Reader Mode** settings to configure the NFC radio.



**Figure 4-14** *Reader Mode Settings*

- **Supported Cards** – Touch to select the type of NFC cards to support. Options: **All Cards** (default), **Type A**, **Type B**, **Type F** or **Type V**.
- **NDEF Support**
  - **Skip NDEF** – Enables or disables the use of NFC Forum tag types 1 through 4. Default: Disabled.
- **Card Detection Mode**
  - **Card detection mode** – Touch to select the card detection mode. Options: **Low power**, **Standard** or **Hybrid** (default).
  - **CPU Speed** – Touch to enhance NFC transaction performance while reading small amounts data. Default: Disabled.
- **Card Communication Speed**
  - **Baud rate for 14443–4 cards** - Options: **106 kbps** (default), **212 kbps**, **424 kbps** or **848 kbps**.





# CHAPTER 5 APPLICATIONS

---

## Introduction

This chapter describes the applications installed on the device.

## Camera

✓ **NOTE** Camera application is only available on configurations with a camera.

This section provides information for taking photos and recording videos using the integrated digital cameras.

✓ **NOTE** If a microSD card is installed, The TC8000 saves photos and videos on the microSD card. If a microSD card is not installed, the TC8000 saves photos and videos on the internal storage.

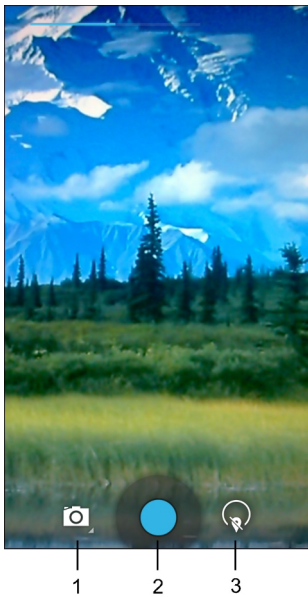


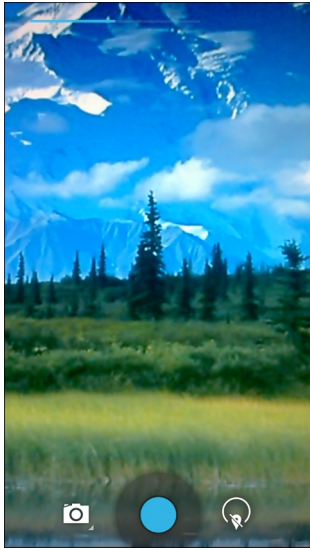
Figure 5-1 Camera Photo Screen

1	Camera Options — Touch to select Camera, Video or Panorama mode.
2	Shutter button - Touch to take a photo, a panoramic photo or to record a video.
3	Photo Settings – Touch to select camera settings.


## Taking Photos

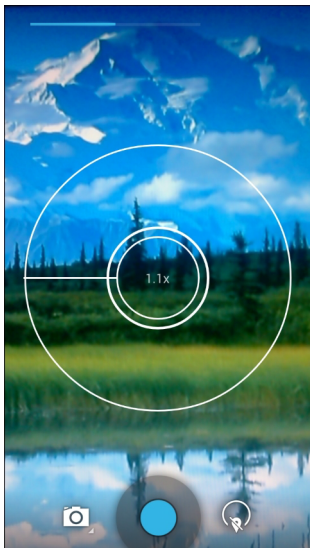
✓ **NOTE** Camera settings are described in *Photo Settings* on page 5-6.

1. Touch .



**Figure 5-2** Camera Mode

2. If necessary, touch the camera options icon and touch .
3. Frame the subject on the screen.
4. To zoom in or out, press two fingers on the display and pinch or expand fingers. The zoom controls appear on the screen.




**Figure 5-3** Camera Zoom

5. Touch an area on the screen to focus. The focus circle appears on the screen. The two horizontal bars turn green when in focus.

6. Touch .


The camera takes a photo and a shutter sound plays.

Alternately, touch  and hold to focus first, before taking a photo; then release to take a focused photo.

The photo momentarily displays as a thumbnail in the upper right corner.

## Taking a Panoramic Photo

Panorama mode lets the user create a single wide image by panning slowly across a scene.

1. Touch .

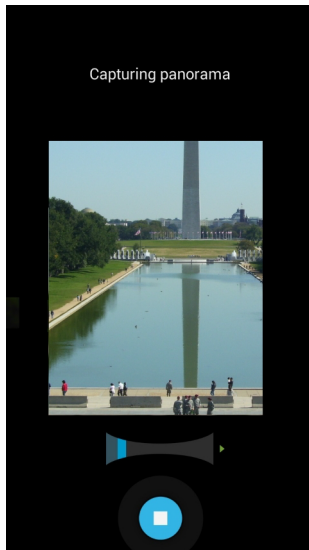





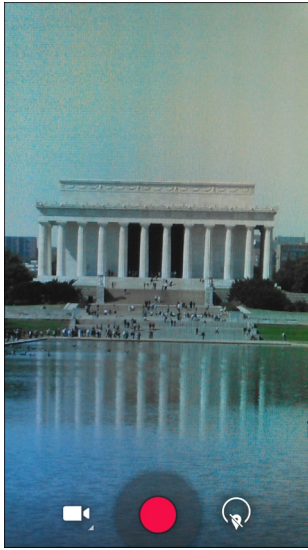
Figure 5-4 *Panoramic Mode*

2. Touch the options bar and touch .
3. Frame one side of the scene to capture.
4. Touch  and slowly start panning across the area to capture. A small white square appears inside the button indicating the capture is in progress.  
If panning too quickly, the message **Too fast** appears.
5. Touch  to end the shot. The panorama appears immediately and a progress indicator displays while it saves the image.


## Recording Videos

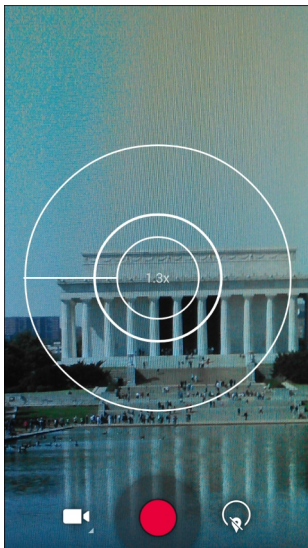
To record a video:

1. Touch .





**Figure 5-5** Video Mode

2. Touch the options bar and touch .
3. Point the camera and frame the scene.
4. To zoom in or out, press two fingers on the display and pinch or expand fingers. The zoom controls appear on the screen.



**Figure 5-6** Camera Zoom

5. Touch  to start recording.  
The device starts recording the video. The video time appears in the top left of the screen.
6. Touch  to end recording.  
The video momentarily displays as a thumbnail in the upper right corner.

## Photo Settings














When in Photo mode, photo settings are displayed on screen. Touch  to display the photo settings options.



Figure 5-7 Photo Setting Options

- **HDR** – Touch to enable High Dynamic Range (HDR) imaging. HDR adds more dynamic range to photographs (the ratio of light to dark). HDR uses three photos, taken at different exposures to create the photo (default - disabled).
- First :
  - **Scene mode** - Touch to select a preset combination of camera settings designed for specific scenes. Options: **Auto** (default), **Night**, **Portrait**, **Landscape**, **Steady Photo**, **Sports** or **Document capture**.
  - **Picture size** - Touch to set the size (in pixels) of the photo. Options: **8M pixels** (default), **5M pixels**, **3M pixels**, **HD 1080p**, **2M pixels**, **HD720**, **1M pixels**, **WVGA**, **VGA** or **QVGA**.
  - **Picture quality** - Touch to select picture quality setting. Options: **Super fine** (default), **Fine** or **Normal**.
  - **ZSL** - Set the camera to immediately take a picture when the button is pressed (default – disabled)
  - **Countdown timer** - Options: **Off** (default), **1 second**, **2 seconds**, **3 seconds**, **4 seconds**, **5 seconds**, **10 seconds**, **15 seconds**, **20 seconds**, **30 seconds** or **60 seconds**.
  - **Beep during countdown** - Select to play a beep tone during countdown (default – enabled).
  - **Storage Position** - Options: **Phone** (default), **SD Card**.
  - **AUTO HDR** - Options: **Disable** (default), **Enable**.
- Second :
  - **Face detection** - Select to enable face detection (default – enabled).
  - **Touch AF/AEC** - Select to enable auto focus (default – enabled).
  - **Sharpness** - Touch to select a sharpness level. Options: **Level 0**, **Level 1**, **Level 2**, **Level 3** (default), **Level 4**, **Level 5** or **Level 6**.
  - **Select Auto Exposure** - Touch to select auto exposure setting. Options: **Frame Average** (default), **Center Weighted** or **Spot Metering**.
- Third :
  - **Anti Banding** - Options: **Off**, **50 Hz**, **60 Hz** or **Auto** (default).
  - **Select ISO** - Set how sensitive the camera is to light. Options: **Auto** (default), **ISO Auto (HJR)**, **ISO100**, **ISO200**, **ISO400**, **ISO800** or **ISO1600**.
  - **Exposure** - Touch to adjust the exposure settings. Options: **+2**, **+1**, **0**(default), **-1** or **-2**.
  - **White balance** - Touch to select how Camera adjusts colors in different kinds of light, to achieve the most natural-looking colors.
    -  **Incandescent** - Adjust the white balance for incandescent lighting.
    -  **Fluorescent** - Adjust the white balance for florescent lighting.
    -  **Auto** - Adjust the white balance automatically (default).
    -  **Daylight** - Adjust the white balance for daylight.

-  **Cloudy** - Adjust the white balance for a cloudy environment.
- **Flash mode** - Touch to set whether Rear-facing Camera relies on its light meter to decide whether a flash is necessary, or to turn it on or off for all shots.
  -  **Off** - Disable flash.
  -  **Auto** - Camera adjusts flash automatically depending upon light meter (default).
  -  **On** - Enable flash upon taking a photo.
  -  **Torch** - Turn flash on continuously.
- **Focus Mode** - Touch to select the camera focus setting. Options: **Auto** (default), **Infinity**, **Macro** or **Continuous Auto Focus (CAF)**.
- **AE-Bracket** - Touch to set Automatic Exposure Bracketing (default – disabled).

## Video Settings









When in Video mode, video settings are displayed on screen. Touch  to display the video settings options.




Figure 5-8 Video Setting Options

- First 
  - **Time lapse** - Touch to select a time interval to set the frame rate for time lapse photography. Options: **Off** (default), Slide switch to **ON** and then set time interval.
  - **Video quality** - Touch to select video quality:
    - **HD 1080p** - High definition 1080p (default).
    - **HD 720p** - High definition 720p.
    - **SD 480p** - Standard definition 480p.
  - **Video duration** - Options: **30 seconds (MMS)** or **30 minutes** (default).
  - **Storage Position** - Options: **Phone** (default), **SD Card**.
- Second 
  - **White balance** - Touch to select how Camera adjusts colors in different kinds of light, to achieve the most natural-looking colors.
    -  **Incandescent** - Adjust the white balance for incandescent lighting.
    -  **Fluorescent** - Adjust the white balance for florescent lighting.
    -  **Auto** - Adjust the white balance automatically (default).
    -  **Daylight** - Adjust the white balance for daylight.
    -  **Cloudy** - Adjust the white balance for a cloudy environment.
  - **Flash mode** - Select to turn on flash (default – disabled).


---

## Contacts


Use the **Contacts** application to manage contacts.

From a Home or Apps screen, touch . Contacts opens to the main list of contacts. View contacts in three ways at the top of the screen: Groups, All contacts, and Favorites. Touch the tabs to change how to view the contacts. Swipe up or down to scroll through the lists.


### Adding Contacts

1. In the Contacts application, touch .
2. If there are more than one account with contacts, touch the one to use.
3. Type the contact's name and other information. Touch a field to start typing, and swipe down to view all categories.
4. To add more than one entry for a category – for example, to add a work address after typing a personal address – touch **Add new** for that field. To open a menu with preset labels, such as Home or Work for an email address, touch the label to the right of the item of contact information. Or, to create your own label, touch **Custom** in the menu.
5. Touch **Done**.

### Editing Contacts

1. In the Contacts application, touch a contact to edit.
2. Touch .
3. Edit the contact information.
4. Touch **Done**.

### Deleting Contacts

1. In the Contacts application, touch a contact to delete.
2. Touch .
3. Touch **Delete**.
4. Touch **OK** to confirm.



## DataWedge Demonstration

Use DataWedge Demonstration to demonstrate data capture functionality.

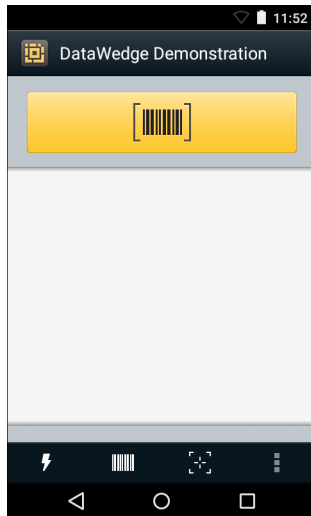


Figure 5-9 DataWedge Demonstration Window

Table 5-1 DataWedge Demonstration Icons

Icon	Description
	Toggles the flash on and off when using the camera to capture bar code data. Use the flash in dimly lit areas.
	Toggles the data capture function between the internal imager/scanner, internal camera or RS507 Hands-free Bluetooth imager (if connected).
	Toggles between normal scan mode and picklist mode when capturing bar code data.
	Opens a menu to view the application information or to set the application DataWedge profile.



**NOTE** See *TC8000 Integrator Guide* for information on DataWedge configuration.

Either press the Scan key or touch the yellow scan button in the application to enable data capture. The captured data appears in the text field below the yellow button.

## Elemez



**NOTE** Elemez collects specific device information in the background and sends this information to us to help improve product functionality. This feature can be disabled.

See Disabling Elemez Data Collection. Ensure that the date, time and time zone are set correctly prior to using Elemez.

Use **Elemez** to provide diagnostics information to us. Touch **Submit Diagnostics** button to send the data.

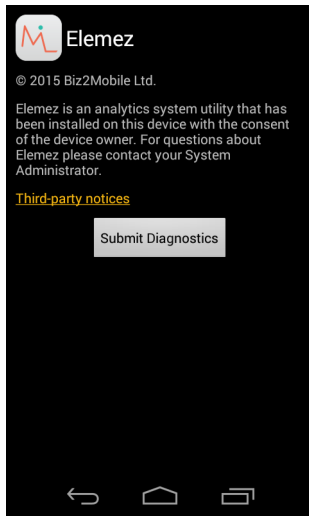






Figure 5-10 *Elemez Application*







## Disabling Elemez Data Collection

The user can disable the Elemez application from collection specific data in the background and sending it to Zebra Technologies.

1. From the Home screen, touch  >  >  **Apps**.
2. Swipe left or right until the **ALL** tab displays.
3. Scroll through the list and touch **Elemez**.
4. In the **App info** screen, touch **Uninstall updates**.
5. In the **Uninstall updates** dialog box, touch **OK**.
6. Touch **OK**.
7. After uninstall is complete, touch **OK**.
8. In the **All** tab, scroll through the list and touch **Elemez**.
9. Touch **Disable**.
10. In the **Disable built-in app?** dialog box, touch **OK**.
11. Touch .

## Enabling Elemez Data Collection

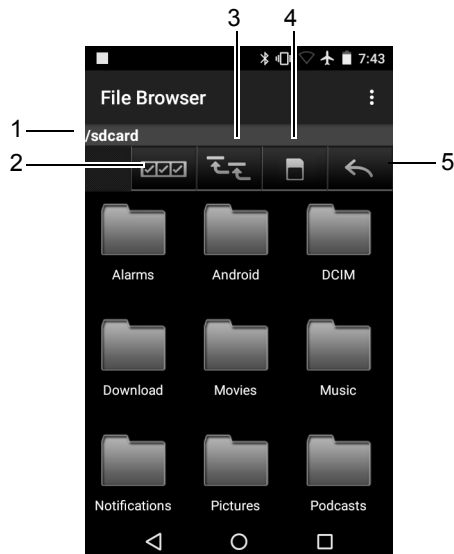
The user can re-enable the Elemez application for collection specific data in the background and sending it to Zebra Technologies.

1. From the Home screen, touch Touch  >  >  **Apps**.
2. Swipe left or right until the **ALL** tab displays.
3. Scroll through the list and touch **elemez**.
4. In the **App info** screen, touch **Enable**.
5. Touch  >  >  **Elemez**.
6. Touch **Enable Elemez**.

## File Browser

Use the **File Browser** application to view and manage files on the device.


To open **File Browser**, touch  > .





**Figure 5-11** File Browser Screen

The address bar (1) indicates the current folder path. Touch the current folder path to manually enter a path and folder name.

Use  (2) to select multiple files/folder.


Use  (3) to view the internal storage root folder.



Use  (4) to view the Internal Storage root folder.






Use  (5) to view the previous folder or to exit the application.

Touch and hold an item to perform an operation on that item. Select one of the options from the **File Operations** menu:

- **Information** - View detailed information about the file or folder.
- **Move** - Move the file or folder to a new location.
- **Copy** - Copy the select file.
- **Delete** - Delete the selected file.
- **Rename** - Rename the select file.
- **Open as** - Open the selected file as a specific file type.
- **Share** - Share the file with other devices.

Touch  to open additional functionality:

- Touch  > **New Folder** to create a new folder in the current folder.
- Touch  > **Search** to search for a file or folder.

- Touch  > **Sort** to sort the list by name, by type, by size or by date.
- Touch  > **Refresh** to re-display the contents of the current folder.
- Touch  > **List View** to change the folder view from tile to list format.
- Touch  > **Change Size** to change the size of the icons: Large, Normal or Small.
- Touch  > **About File Browser** to view the application version information.

## Gallery

✓ **NOTE** The device supports the following image formats: jpeg, gif, png and bmp.

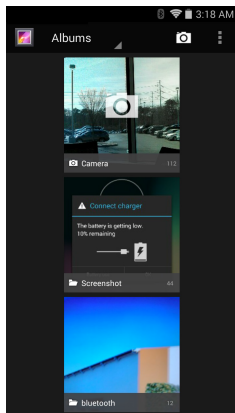
The device supports the following video formats: H.263, H.264 and MPEG4 Simple Profile.

Use Gallery to:



- view photos
- play videos
- perform basic editing of photos
- set photos as wallpaper
- set photos as a contact photo
- share photos and videos.

To open the Gallery application, touch  > .

Gallery presents all photos and videos stored in memory.



**Figure 5-12** Gallery — Albums

- Touch an album to open it and view its contents. The photos and videos in the album are displayed in chronological order.
- Touch a photo or video in an album to view it.
- Touch  icon (top left corner) to return to the main **Gallery** screen.
- Touch  to return to the main **Gallery** screen.

## Working with Albums




Albums are groups of images and videos in folders. Touch an album to open it. The photos and videos are listed in a chronologically ordered grid. The name of the album displays at the top of the screen.






**Figure 5-13** *Photos Inside an Album*

Swipe left or right to scroll images across the screen.

## Share an Album




1. Touch  > .
2. Touch and hold an album until it highlights.
3. Touch other albums as required.
4. Touch . The Share menu opens. Touch the application to use to share the selected albums.
5. Follow the instructions within the selected application.

## Get Album Information

1. Touch  > .
2. Touch and hold an album until it highlights.
3. Touch .
4. Touch **Details**.

## Deleting an Album

To delete an album and its contents:

1. Touch  > .
2. Touch and hold an album until it highlights.
3. Check other albums to delete. Ensure that other albums are selected.
4. Touch .



5. Touch **Delete**.
6. In the **Delete selected item** dialog, touch **OK** to delete the album.

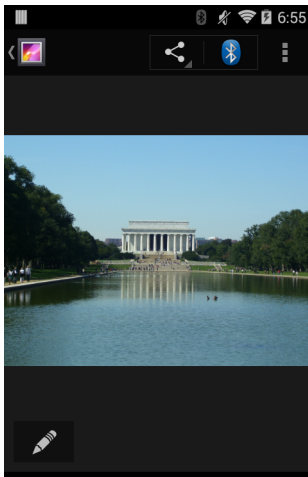
## Working with Photos

Use Gallery to view photos and edit and share photos.

## Viewing and Browsing Photos

To view a photo:


1. Touch  > .
2. Touch an album to open it.
3. Touch a photo.



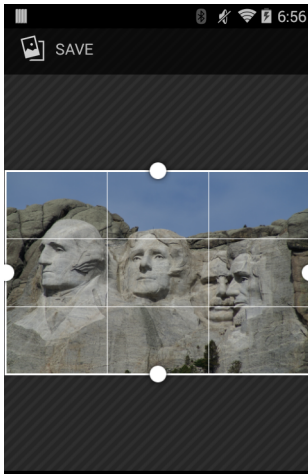
**Figure 5-14** *Photo Example*

4. Swipe left or right to view the next or previous photo in the album.
5. Touch the photo to view the controls.
6. Double-tap the screen to zoom in or pinch two fingers together or spread them apart to zoom in or out.
7. Drag the photo to view parts that are not in view.

## Cropping a Photo

1. In Gallery, touch a photo to view the controls.
2. Touch  .
3. Touch **Crop**. The white cropping tool appears.
4. Use the cropping tool to select the portion of the photo to crop.
  - Drag from the inside of the cropping tool to move it.
  - Drag an edge of the cropping tool to resize it to any proportion.
  - Drag a corner of the cropping tool to resize it with fixed proportions.











**Figure 5-15** *Cropping Tool*

5. Touch **SAVE** to save a copy of the cropped photo. The original version is retained.

### Setting a Photo as a Contact Icon


1. Touch  > .
2. Touch an album to open it.
3. Touch the photo to open it.
4. Touch .
5. Touch **Set picture as**.
6. Touch **Contact photo**.
7. In the Contacts application, touch a contact.
8. Touch the white box and crop the photo accordingly.
9. Touch **OK**.

### Share a Photo

1. Touch  > .
2. Touch an album to open it.
3. Touch a photo to open it.
4. Touch .
5. Touch the application to use to share the selected photo. The application selected opens with the photo attached to a new message.

### Deleting a Photo



1. Touch  > .

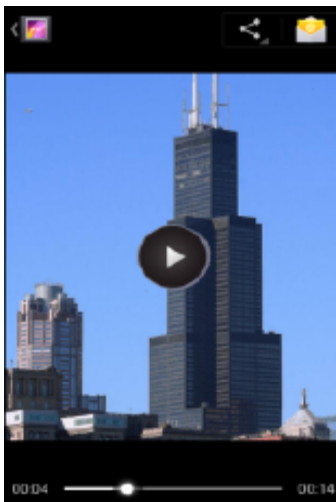
2. Touch an album to open it.
3. Touch a photo to open it.
4. Touch  .
5. Touch **Delete**.
6. In the **Delete selected item** dialog, touch **OK** to delete the photo.

## Working with Videos


Use Gallery to view videos and share videos.

### Watching Videos




1. Touch  >  .
2. Touch an album to open it.
3. Touch a video.






**Figure 5-16** *Video Example*

4. Touch  . The video begins to play.
5. Touch the screen to view the playback controls.

### Sharing a Video

1. Touch  >  .
2. Touch an album to open it.
3. Touch a video to open it.
4. Touch  . The Share menu appears.
5. Touch the application to use to share the selected video. The application selected opens with the video attached to a new message.

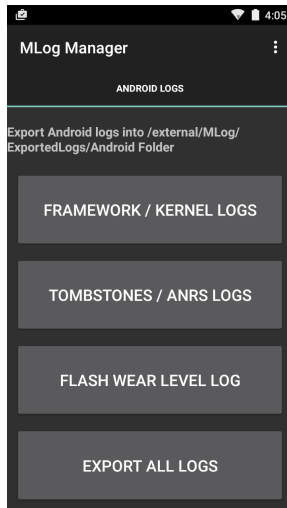
## Deleting a Video

1. Touch  > .
2. Touch an album to open it.
3. Touch a video to open it.
4. Touch .
5. Touch **Delete**.
6. In the **Delete selected item** dialog, touch **OK** to delete the video.

---

## MLog Manager

Use **MLog Manager** to capture log files for diagnostics. See the *TC8000 Integrator Guide* for detailed information on configuring the application.



**Figure 5-17** *MLog Manager*

---

## Print Station

Use the **Print Station** application to print labels and receipts directly to a Zebra ZPL printer via USB, Bluetooth or WLAN.

Features include:

- Discovering and pairing with Zebra printers via a Bluetooth, WLAN or USB connection.
- Retrieving and displaying a list of document templates stored on the device and on the printer.
- Using document templates to generate on-screen prompts allowing data entry at print time.
- Using the camera on the device to scan bar codes for data entry.
- Supports multiple Zebra printer models using the ZPL command language.

## PTT Express Voice Client

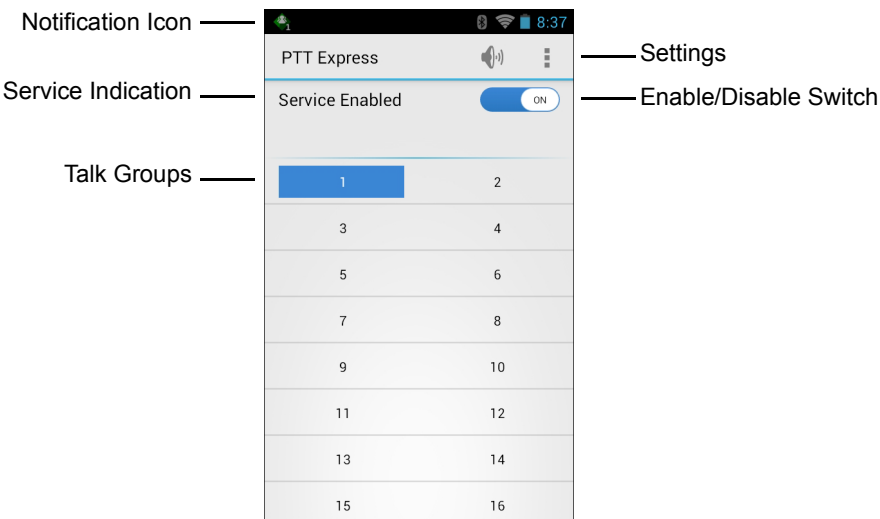
✓ **NOTE** PTT Express Voice Client creates Push-To-Talk (PTT) communication capability between disparate enterprise devices. Leveraging existing Wireless Local Area Network (WLAN) infrastructure, PTT Express delivers simple PTT communication without the need of a voice communication server.

- Group Call: Press and hold the PTT (Talk) button to start communicating with other voice client users.

### PTT Audible Indicators

The following tones provide helpful cues when using the voice client.

- **Talk Tone:** Double chirp. Plays when the Talk button is depressed. This is a prompt for the user to start talking.
- **Access Tone:** Single beep. Plays when another user just finished a broadcast or response. The user is now able to initiate a Group Broadcast or Private Response.
- **Busy Tone:** Continuous tone. Plays when the Talk button is depressed and another user is already communicating on the same talkgroup. Plays after the maximum allowed talk time is reached (60 seconds).
- **Network Tone:**
  - Three increasing pitch beeps. Plays when PTT Express has acquired the WLAN connection and the service is enabled.
  - Three decreasing pitch beeps. Plays when PTT Express has lost the WLAN connection or the service is disabled.



**Figure 5-18** PTT Express Default User Interface








**Table 5-2** PTT Express Default User Interface Descriptions

Item	Description
Notification Icon	Indicates the current state of the PTT Express client.
Service Indication	Indicates the status of the PTT Express client. Options: Service Enabled, Service Disabled or Service Unavailable.
Talk Groups	Lists all 32 Talk Groups available for PTT communication.
Settings	Opens the PTT Express Settings screen.
Enable/Disable Switch	Turns the PTT service on and off.

## Notification Icons

Indicates the current state of the PTT Express Voice client.

**Table 5-3** PTT Express Default User Interface Descriptions

Status Icon	Description
	Indicates that PTT Express Voice client is disabled.
	Indicates that PTT Express Voice client is enabled but not connected to a WLAN.
	Indicates that PTT Express Voice client is enabled, connected to a WLAN and listening on the Talk Group indicated by the number next to the icon.
	Indicates that PTT Express Voice client is enabled, connected to a WLAN and communicating on the Talk Group indicated by the number next to the icon.
	Indicates that PTT Express Voice client is enabled, connected to a WLAN and in a private response.
	Indicates that PTT Express Voice client is enabled and muted.
	Indicates that the PTT Express Voice client is enabled but it is not able to communicate due to a VoIP telephony call is in progress.

## Enabling PTT Communication

1. Touch  > .
2. Slide the **Enable/Disable Switch** to the **ON** position. The button changes to an **ON** button.

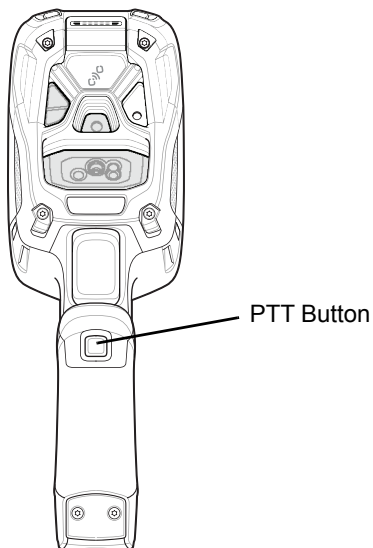
## Selecting a Talk Group

One of 32 Talk Groups can be selected by PTT Express users. However, only one talk group may be enabled at a time on the device. Touch one of the 32 Talk Groups. The selected Talk Group is highlighted.

## PTT Communication

✓ **NOTE** This section describes the default PTT Express client configuration. See the *PTT Express V1.2 User Guide* for detailed information on using the client.

PTT communication may be established as a Group Call. When PTT Express is enabled, the PTT button on the left side of the device is assigned for PTT communication. When the Wired Headset is used, Group Calls can also be initiated using the headset Talk button.



**Figure 5-19** PTT Button



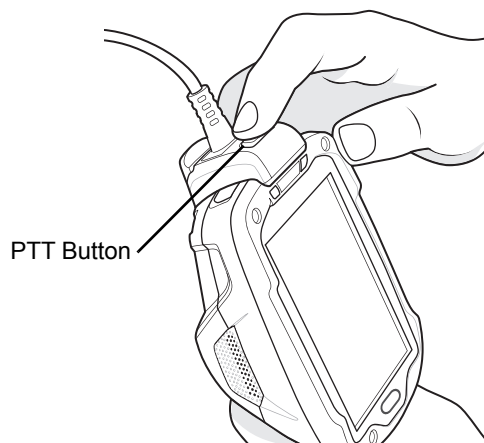


Figure 5-20 *Wired Headset*

## Creating a Group Call

To create a group call:

1. Press and hold the PTT button (or the Talk button on the headset) and listen for the talk tone to play.  
If a busy tone is heard, release the button and wait a moment before making another attempt. Ensure that PTT Express and the WLAN are enabled.
2. Start talking after the talk tone is heard.

✓ **NOTE** If the user holds the button for more than 60 seconds (default), the call is dropped allowing others to make Group calls. The user should release the button when finished talking to allow others to make calls.

3. Release the button when finished talking.

## Disabling PTT Express Voice Client Communication

1. Touch  > .
2. Slide the **Enable/Disable Switch** to the **OFF** position. The button changes to **OFF**.
3. Touch .

## RxLogger

RxLogger is a comprehensive diagnostic tool that provides application and system metrics. It allows for custom plug-ins to be created and work seamlessly with this tool. RxLogger is used to diagnose device and application issues. Its information tracking includes the following: CPU load, memory load, memory snapshots, battery consumption, power states, wireless logging, cellular logging, TCP dumps, Bluetooth logging, GPS logging, logcat, FTP push/pull, ANR dumps, etc. All logs and files generated are saved onto flash storage on the device (internal or external).

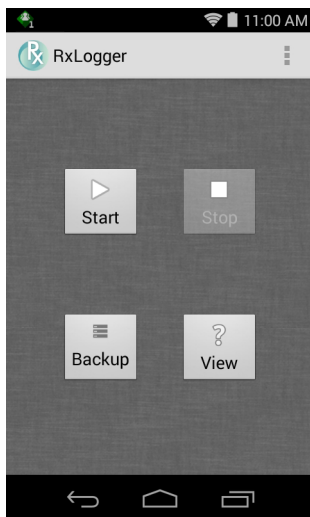



Figure 5-21 RxLogger




### RxLogger Configuration

RxLogger is built with an extensible plug-in architecture and comes packaged with a number of plugins already built-in. The included plug-ins are described below. Touch  > **Settings** to open the configuration screen.

#### Configuration File

RxLogger configuration can be set using an XML file. The *config.xml* configuration file is located on the **Enterprise storage** in the `RxLogger\config` folder. Copy the file from the device to a host computer using a USB connection. Edit the configuration file and then replace the .XML file on the device. There is no need to stop and restart the RxLogger service since the file change is automatically detected.

### Enabling Logging

1. Touch  > .
2. Touch **Start**.
3. Touch .

## Disabling Logging








1. Touch  > .
2. Touch **Stop**.
3. Touch .

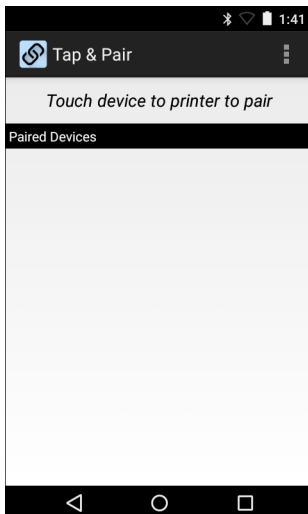
## Extracting Log Files

1. Connect the device to a host computer using an USB connection.
2. Using a file explorer, navigate to the **Internal Storage** in the `/RxLogger` folder.
3. Copy the file from the device to the host computer.
4. Disconnect the device from the host computer.

## Tap & Pair

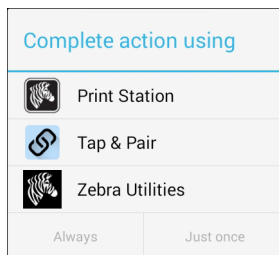
Use the **Tap & Pair** application to easily connect to a Zebra printer.

1. Enable Bluetooth and NFC:
  - a. Touch  >  >  **Bluetooth**.
  - b. Slide the **Bluetooth** switch to the ON position.
  - c. Touch .
  - d. Touch **More**.
  - e. Slide the **NFC** switch to the ON position.
  - f. Touch .
2. Touch  > .



**Figure 5-22** Tap & Pair Application

3. Touch the back of the TC8000 to the NFC logo on the Zebra printer.



**Figure 5-23** Complete Action Dialog Box

4. Tap **Tap & Pair** and then tap **Just once**.

The printer displays the pair code on the display. Verify that this code matches the code shown on the TC8000.

5. Tap **PAIR**.

6. Verify that the Zebra printer is in the list of paired devices.



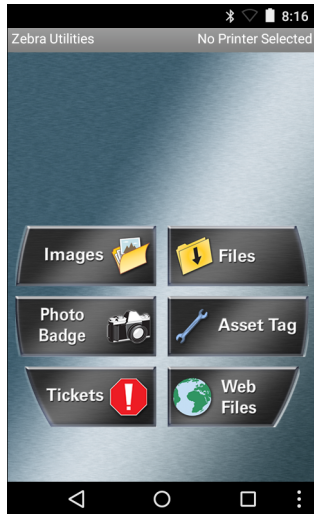
**Figure 5-24** Paired Printer List

7. Tap the Zebra printer in the **Paired Devices** list to print a test page.
8. Tap **OK** to print the test page.

---

## Zebra Utilities

Use the **Zebra Utilities** app to print bar code labels and receipts directly to a Zebra printer via Bluetooth or WLAN.



**Figure 5-25** *Zebra Utilities*

Goto <http://www.zebra.com/support> for more information.

# CHAPTER 6 ACCESSORIES

## Accessories

Table 6-1 *Accessories*

Accessory	Part Number	Description
<b>Cradles</b>		
2-Slot USB Charge Cradle	CRD-TC8X-2SUCHG-01	Provides device and spare battery charging and USB communication with a host computer. Use with power supply, p/n PWRS-14000-148R and country specific grounded AC line cord.
5-Slot Charge Only Cradle	CRD-TC8X-5SCHG-01	Charges up to five TC8000 devices. Use with power supply, p/n PWRS-14000-241R, DC line cord, p/n 50-16002-029R and country specific grounded AC line cord.
5-Slot Ethernet Cradle	CRD-TC8X-5SETH-01	Provides device charging and provides Ethernet communication for up to five devices. Use with power supply, p/n PWRS-14000-241R, DC line cord, p/n 50-16002-029R and country specific grounded AC line cord.
5-Slot Charge Only Cradle with Battery Charger	CRD-TC8X-5SC4BC-01	Charges up to four TC8000 devices and four spare batteries. Use with power supply, p/n PWRS-14000-241R, DC line cord, p/n 50-16002-029R and country specific grounded AC line cord.
5-Slot Ethernet Cradle with Battery Charger	CRD-TC8X-5SE4BC-01	Provides device charging and provides Ethernet communication for up to four devices. Provides charging for four spare batteries. Use with power supply, p/n PWRS-14000-241R, DC line cord, p/n 50-16002-029R and country specific grounded AC line cord.

**Table 6-1** Accessories (Continued)

Accessory	Part Number	Description
<b>Batteries and Chargers</b>		
Battery	BTRY-TC8X-67MA1-01 BTRY-TC8X-67MA1-10	Replacement battery (single pack). Replacement battery (10-pack).
4-Slot Battery Charger	SAC-TC8X-4SCHG-01	Charges up to four spare batteries. Requires power supply, p/n PWRS-14000-148R and country specific grounded AC line cord.
USB and Charging Cable	CBL-TC8X-USBCHG-01	Provides USB communication and power to the device. Requires power supply PWRS-14000-249R and country specific un-grounded AC line cord.
<b>Audio Accessories</b>		
Quick Disconnect Audio Cable	CBL-TC8X-AUDQD-01	Snaps onto the device and provides audio to a wired headset with Quick Disconnect connector.
3.5 mm Audio Cable	CBL-TC8X-AUDBJ-01	Snaps onto the device and provides audio to a wired headset with 3.5 mm plug.
<b>Mounting Brackets</b>		
2-Slot Cradle Desktop Stand	BRKT-SCRD-SSDK-01	Use for mounting a 2-Slot cradle on a desk.
5-Slot Cradle Desktop Stand	BRKT-SCRD-MSDK-01	Use for mounting a 5-Slot cradle on a desk or rack.
Rack Mount Bracket	BRKT-SCRD-SMRK-01	Use for mounting a 5-Slot cradle or four 4-Slot Battery Chargers on a rack.
Desktop Stand	MNT-TC8X-DKPH-01	Un-powered desktop presentation stand. Allows to use the device on a flat surface (i.e. desktop) for hands-free scanning.
Cart Mount	MNT-TC8X-CMKT-01	Un-powered cart mount. Allows to use the device on carts with up to 2" diameter rail/bar and allows to use the device on hands-free scanning mode. Includes RAM Mount required for installation.
Forklift Mount	MNT-TC8X-FMKT-01	Un-powered forklift mount. Allows to install the device on a roll bar or square surface of a forklift and allows to use the device on landscape or portrait mode.
<b>Carrying Solutions</b>		
Hand Strap	SG-TC8X-HDSTP-01	Replacement hand strap.
Wrist Lanyard	50-12500-006	Optional lanyard for holding the device.
Quick Draw Soft Holster	SG-TC8X-QDHLST-01	Use to hold the device. Requires the Universal Belt.
Presentation Soft Holster	SG-TC8X-PMHLST-01	Use to hold the device and for hands-free scanning. Requires the Universal Shoulder Strap or Universal Belt.



**Table 6-1** Accessories (Continued)

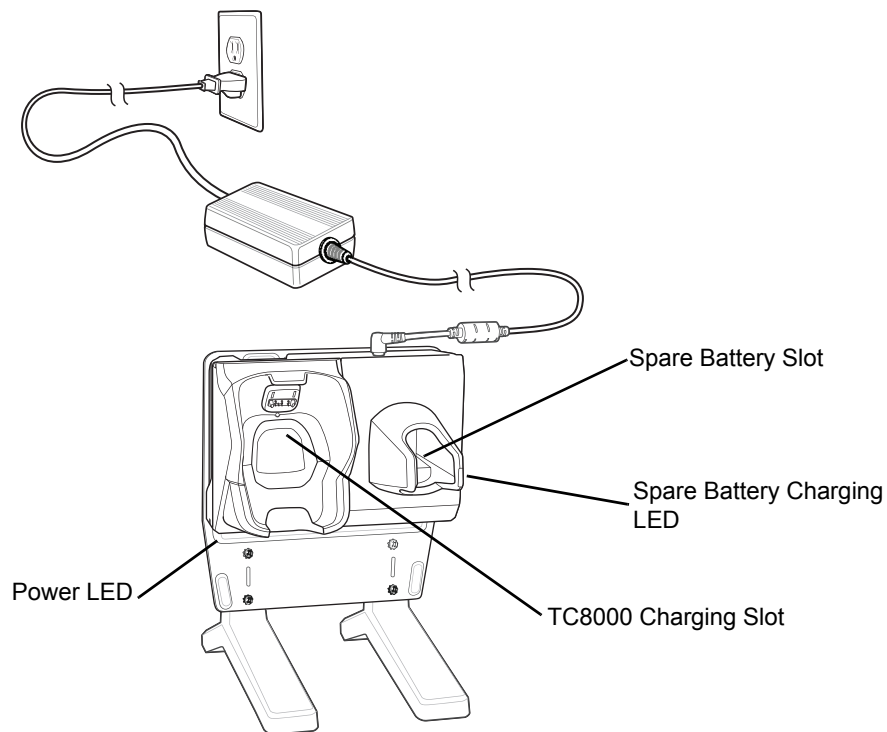
Accessory	Part Number	Description
Universal Belt	11-08062-02R	Use to hold the Quick Draw Soft Holster or the Presentation Soft Holster.
Universal Shoulder Strap	WA6010	Use to hold the Presentation Soft Holster.
<b>Power Supplies</b>		
Power Supply	PWRS-14000-249R	Provides power to the device using the USB and Charging Cable. Requires country specific un-grounded AC line cord.
Power Supply	PWRS-14000-148R	Provides power to the 2-Slot cradles and 4-Slot Spare Battery Charger. Requires country specific grounded AC line cord.
Power Supply	PWRS-14000-241R	Provides power to the 5-Slot Charge Only Cradle, 5-Slot Ethernet Cradle, 5-Slot Charge Only Cradle with Battery Charger and the 5-Slot Ethernet Cradle with Battery Charger. Requires DC Line Cord, p/n 50-16002-029R and country specific grounded AC line cord.
DC Y Cable	25-85993-01R	Provides power from the PWRS-14000-241R power supply to two 4-Slot Battery Chargers.
DC Line Cord	50-16002-029R	Provides power from the power supply to the 5-Slot Charge Only Cradle, 5-Slot Ethernet Cradle, 5-Slot Charge Only Cradle with Battery Charge and 5-Slot Ethernet Cradle with Battery Charger.
<b>Miscellaneous</b>		
Stylus	SG-TC7X-STYLUS-03	Stylus for use with the device (3-pack).
Screen Protectors	MISC-TC8X-SCRN-01	Provides additional protection for display (5-pack).
Replacement Condensation Resistant Back Housing	MISC-TC8X-DSCNT-01	Field replaceable desiccant cartridge for condensation resistant TC8000 models.

## 2-Slot Charge Only Cradle

✓ **NOTE** Ensure that you follow the guidelines for battery safety described in *Battery Safety Guidelines* on page 7-1.

The 2-Slot Charge Only Cradle:

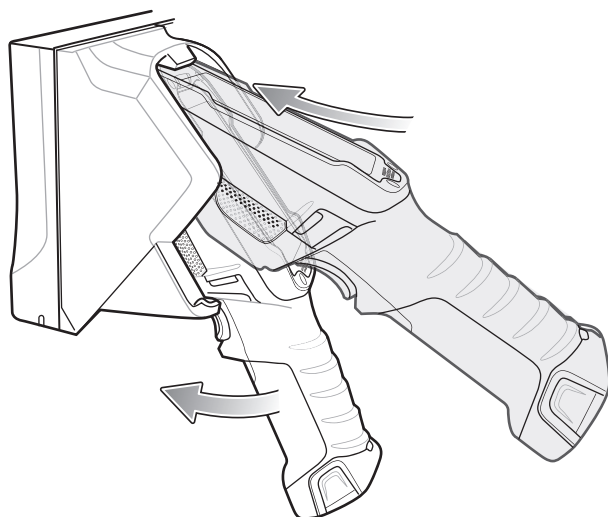
- provides 5 VDC (nominal) power for operating the device
- charges a spare battery.



**Figure 6-1** 2-Slot Charge Only Cradle (shown on optional Desk Mount)

### Charging the Device

1. Insert the device into the TC8000 charge well.



**Figure 6-2** Insert TC8000 into Cradle

2. Ensure the device is seated properly. The Charging/Scan LED blinks indicating charging.

## Charging the Spare Battery

1. Insert a spare battery into the spare battery slot.
2. Ensure the battery is seated properly. The Spare Battery Charging LED blinks indicating charging.

## Battery Charging

### Main Battery Charging

The TC8000 Charging/Scan LED indicates the status of the battery charging in the device. See [Table 1-3 on page 1-10](#). The 6,700 mAh battery fully charges in less than four hours at room temperature.

### Spare Battery Charging

The Spare Battery Charging LED indicates the status of the spare battery charging. The 6,700 mAh battery fully charges in less than four hours at room temperature.

**Table 6-2** Spare Battery Charging LED Indicators

State	Indication
Off	The battery is not charging. The battery is not inserted correctly in the cradle or connected to a power source. Cradle is not powered.
Solid Amber	Healthy battery is charging.
Solid Green	Healthy battery charging is complete.
Fast Blinking Red (2 blinks/second)	Charging error, e.g.: - Temperature is too low or too high. - Charging has gone on too long without completion (typically eight hours).
Solid Red	Unhealthy battery is charging or fully charged.

## Charging Temperature

Charge batteries in temperatures from 0 °C to 40 °C (32 °F to 104 °F). The device or cradle always performs battery charging in a safe and intelligent manner. At higher temperatures (e.g. approximately +37 °C (+98 °F)) the device or cradle may for small periods of time alternately enable and disable battery charging to keep the battery at acceptable temperatures. The device and cradle indicates when charging is disabled due to abnormal temperatures via its LED.

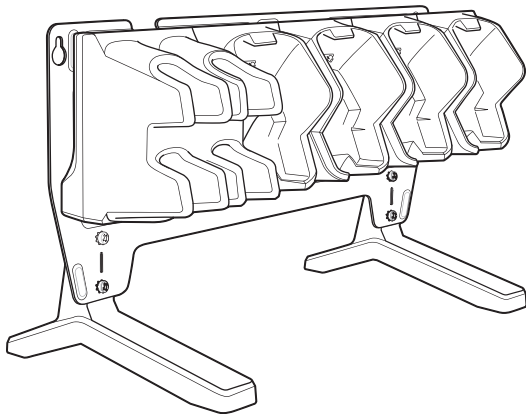
---

## 5-Slot Charge Only Cradle

- ✓ **NOTE** Ensure that you follow the guidelines for battery safety described in *Battery Safety Guidelines* on page 7-1.

The 5-Slot Charge Only Cradle:

- Provides 5 VDC (nominal) power for operating the TC8000.
- Simultaneously charges up to five TC8000s.

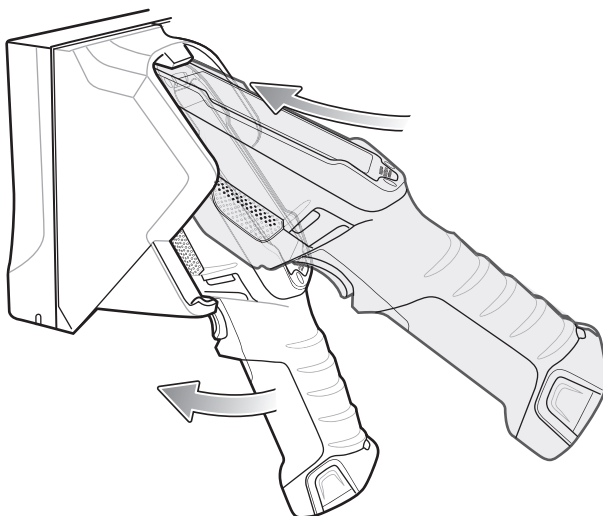


**Figure 6-3** 5-Slot Charge Only Cradle (shown on optional Desk Mount)

## Charging the TC8000

To Charge the TC8000:

1. Insert the TC8000 in a charge well to begin charging.



**Figure 6-4** Insert TC8000 into Cradle

2. Ensure that the TC8000 is properly seated in the charge well.

## Battery Charging

### Main Battery Charging

The TC8000 Charging/Scan LED indicates the status of the battery charging in the device. See [Table 1-3 on page 1-10](#). The 6,700 mAh battery fully charges in less than four hours at room temperature.

### Charging Temperature

Charge batteries in temperatures from 0 °C to 40 °C (32 °F to 104 °F). The battery charger always performs battery charging in a safe and intelligent manner. At higher temperatures (e.g. approximately +37 °C (+98 °F)) the battery charger may for small periods of time alternately enable and disable battery charging to keep the battery at acceptable temperatures. The battery charger indicates when charging is disabled due to abnormal temperatures via its LED.

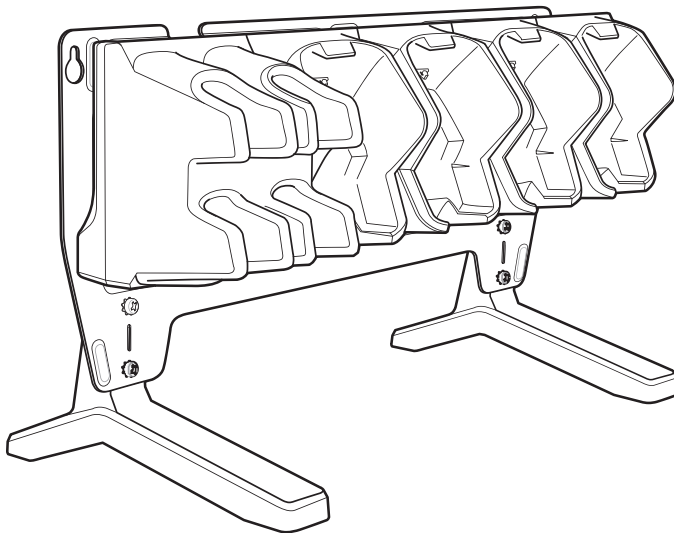
---

## 5-Slot Charge Only Cradle with Battery Charger

✓ **NOTE** Ensure that you follow the guidelines for battery safety described in *Battery Safety Guidelines* on page 7-1.

The 5-Slot Charge Only Cradle with Battery Charger:

- Provides 5 VDC (nominal) power for operating the TC8000.
- Simultaneously charges up to four TC8000s.
- Simultaneously charges up to four spare batteries.

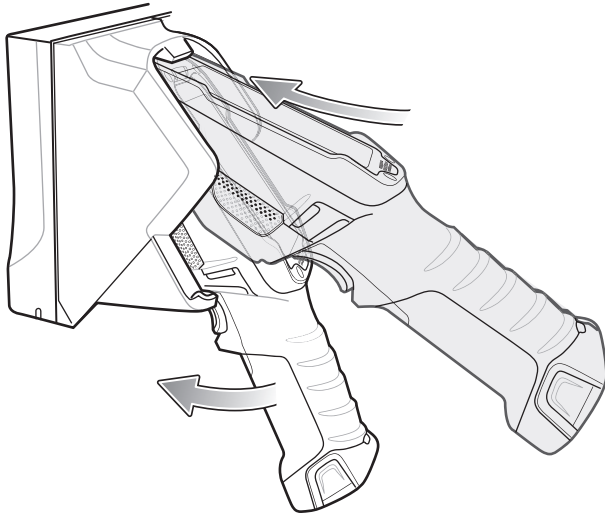


**Figure 6-5** 5-Slot Charge Only Cradle with Battery Charger (shown on optional Desk Mount)

### Charging the Device

To Charge the TC8000:

1. Insert the TC8000 in a charge well to begin charging.



**Figure 6-6** Insert TC8000 into Cradle

2. Ensure that the TC8000 is properly seated in the charge well.

## Charging the Spare Battery

1. Insert a spare battery into the spare battery slot.
2. Ensure the battery is seated properly. The Spare Battery Charging LED blinks indicating charging.

## Battery Charging

### Main Battery Charging

The TC8000 Charging/Scan LED indicates the status of the battery charging in the device. See [Table 1-3 on page 1-10](#). The 6,700 mAh battery fully charges in less than four hours at room temperature.

### Spare Battery Charging

Each Battery Charging LED indicates the status of the battery charging in each slot. The table below describes the Battery Charging LED status. The 6,700 mAh battery fully charges in less than four hours at room temperature.

**Table 6-3** Spare Battery Charging Indicators

State	Indication
Off	Battery is not charging. It is not inserted correctly in the cradle or connected to a power source. Charge is not powered.
Solid Amber	Healthy battery is charging.
Solid Green	Healthy battery charging is complete.



**Table 6-3** Spare Battery Charging Indicators

State	Indication
Fast Blinking Red (2 blinks/second)	Charging error, e.g.: - Temperature is too low or too high. - Charging has gone on too long without completion (typically eight hours).
Solid Red	Unhealthy battery is charging or fully charged.

## Charging Temperature

Charge batteries in temperatures from 0 °C to 40 °C (32 °F to 104 °F). The battery charger always performs battery charging in a safe and intelligent manner. At higher temperatures (e.g. approximately +37 °C (+98 °F)) the battery charger may for small periods of time alternately enable and disable battery charging to keep the battery at acceptable temperatures. The battery charger indicates when charging is disabled due to abnormal temperatures via its LED.

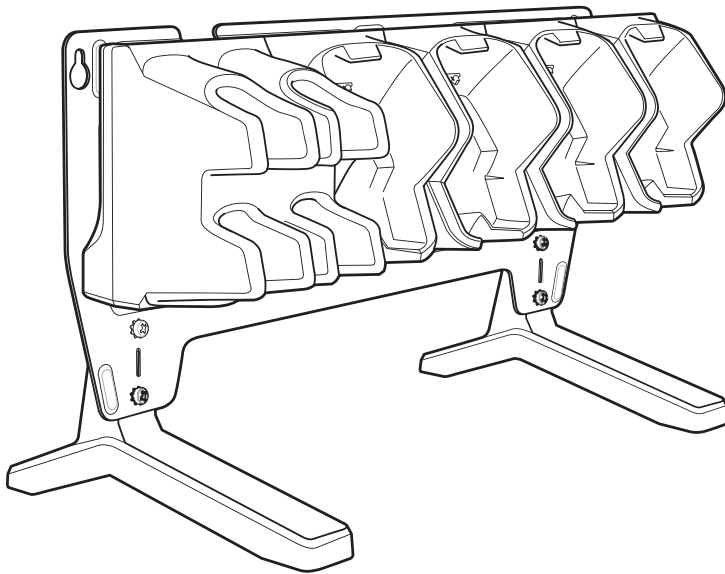
---

## 5-Slot Ethernet Cradle

✓ **NOTE** Ensure that you follow the guidelines for battery safety described in *Battery Safety Guidelines* on page 7-1.

The 5-Slot Ethernet Cradle:

- Provides 5 VDC (nominal) power for operating the TC8000.
- Connects up to five TC8000s to an Ethernet network.
- Simultaneously charges up to five TC8000s.

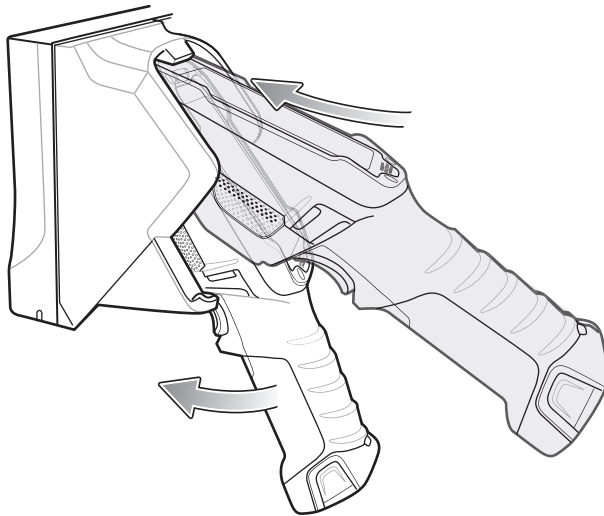


**Figure 6-7** 5-Slot Ethernet Cradle (shown on optional Desk Mount)

## Charging the TC8000

To charge the TC8000:

1. Insert the TC8000 in a charge well to begin charging.



**Figure 6-8** Insert TC8000 into Cradle

2. Ensure that the TC8000 is properly seated in the charge well.

## Battery Charging

### Main Battery Charging





The TC8000 Charging/Scan LED indicates the status of the battery charging in the device. See [Table 1-3 on page 1-10](#). The 6,700 mAh battery fully charges in less than four hours at room temperature.

## Charging Temperature

Charge batteries in temperatures from 0 °C to 40 °C (32 °F to 104 °F). The battery charger always performs battery charging in a safe and intelligent manner. At higher temperatures (e.g. approximately +37 °C (+98 °F)) the battery charger may for small periods of time alternately enable and disable battery charging to keep the battery at acceptable temperatures. The battery charger indicates when charging is disabled due to abnormal temperatures via its LED.

## Establishing Ethernet Communication

✓ **NOTE** Refer to the TC8000 Integrator Guide for information on configuring the Ethernet settings.

1. Touch  >  >  **Ethernet**.
2. Slide the Ethernet switch to the **ON** position.
3. Insert the device into a slot.
4. The  icon appears in the Status bar.
5. Touch **Eth0** to view Ethernet connection details.

### Ethernet LED Indicators

There are two green LEDs on the side of the cradle. These green LEDs light and blink to indicate the data transfer rate.

**Table 6-4** *LED Data Rate Indicators*

<b>Data Rate</b>	<b>1000 LED</b>	<b>100/10 LED</b>
1 Gbps	On/Blink	Off
100 Mbps	Off	On/Blink
10 Mbps	Off	On/Blink

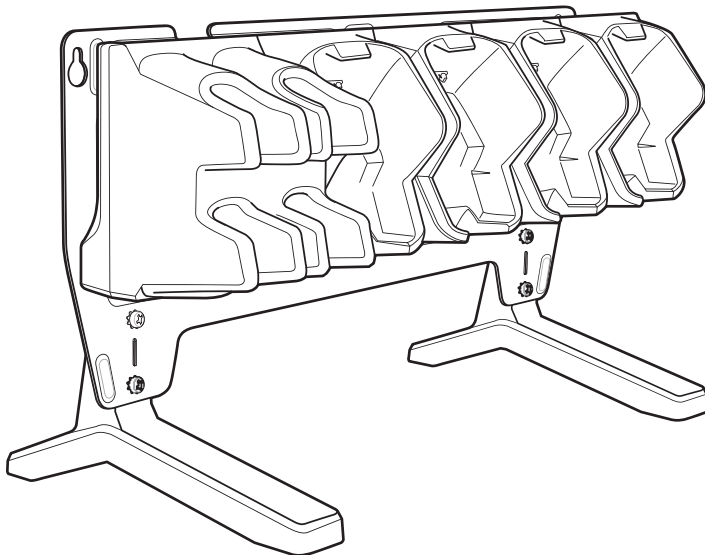
---

## 5-Slot Ethernet Cradle with Battery Charger

✓ **NOTE** Ensure that you follow the guidelines for battery safety described in *Battery Safety Guidelines* on page 7-1.

The 5-Slot Ethernet Cradle:

- Provides 5 VDC (nominal) power for operating the TC8000.
- Connects up to four TC8000s to an Ethernet network.
- Simultaneously charges up to four TC8000s.
- Simultaneously charges up to four spare batteries.

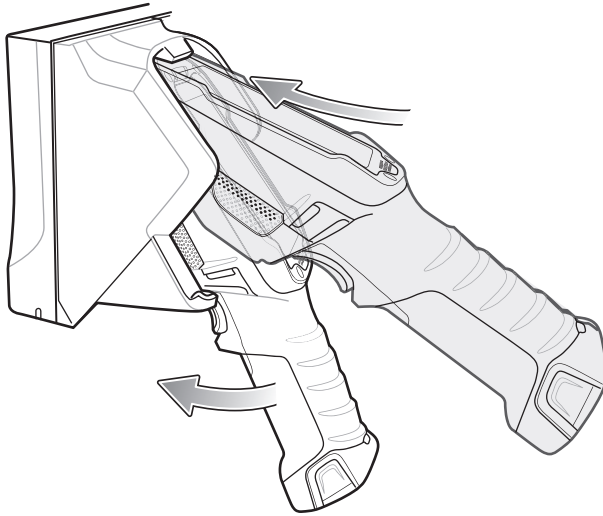


**Figure 6-9** 5-Slot Ethernet Cradle with Battery Charger (shown on optional Desk Mount)

### Charging the TC8000

To charge the TC8000:

1. Insert the TC8000 in a charge well to begin charging.



**Figure 6-10** *Insert TC8000 into Cradle*

2. Ensure that the TC8000 is properly seated in the charge well.

## Charging the Spare Battery

1. Insert a spare battery into the spare battery slot.
2. Ensure the battery is seated properly. The Spare Battery Charging LED blinks indicating charging.

## Battery Charging

### Main Battery Charging

The TC8000 Charging/Scan LED indicates the status of the battery charging in the device. See [Table 1-3 on page 1-10](#). The 6,700 mAh battery fully charges in less than four hours at room temperature.

### Spare Battery Charging

Each Battery Charging LED indicates the status of the battery charging in each slot. The table below describes the Battery Charging LED status. The 6,700 mAh battery fully charges in less than four hours at room temperature.

**Table 6-5** *Battery Charging Indicators*

State	Indication
Off	Battery is not charging. It is not inserted correctly in the cradle or connected to a power source. Charge is not powered.
Solid Amber	Healthy battery is charging.
Solid Green	Healthy battery charging is complete.

**Table 6-5** Battery Charging Indicators (Continued)





State	Indication
Fast Blinking Red (2 blinks/second)	Charging error, e.g.: - Temperature is too low or too high. - Charging has gone on too long without completion (typically eight hours).
Solid Red	Unhealthy battery is charging or fully charged.

## Charging Temperature

Charge batteries in temperatures from 0 °C to 40 °C (32 °F to 104 °F). The battery charger always performs battery charging in a safe and intelligent manner. At higher temperatures (e.g. approximately +37 °C (+98 °F)) the battery charger may for small periods of time alternately enable and disable battery charging to keep the battery at acceptable temperatures. The battery charger indicates when charging is disabled due to abnormal temperatures via its LED.

## Establishing Ethernet Communication

✓ **NOTE** Refer to the *TC8000 Integrator Guide* for information on configuring the Ethernet settings.

1. Touch  >  >  **Ethernet**.
2. Slide the Ethernet switch to the **ON** position.
3. Insert the device into a slot.
4. The  icon appears in the Status bar.
5. Touch **Eth0** to view Ethernet connection details.

### Ethernet LED Indicators

There are two green LEDs on the side of the cradle. These green LEDs light and blink to indicate the data transfer rate.

**Table 6-6** LED Data Rate Indicators

Data Rate	1000 LED	100/10 LED
1 Gbps	On/Blink	Off
100 Mbps	Off	On/Blink
10 Mbps	Off	On/Blink

## 4-Slot Battery Charger

✓ **NOTE** Ensure that you follow the guidelines for battery safety described in *Battery Safety Guidelines* on page 7-1.

The 4-Slot Battery Charger charges up to four TC8000 batteries.

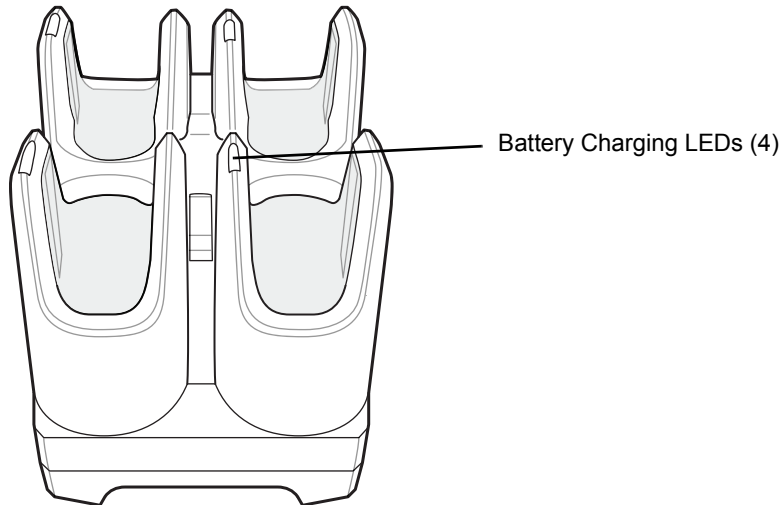


Figure 6-11 4-Slot Battery Charger

## Battery Installation

To install the battery:

1. Insert the battery into a battery slot.
2. Gently press down on the battery until it snaps into place.

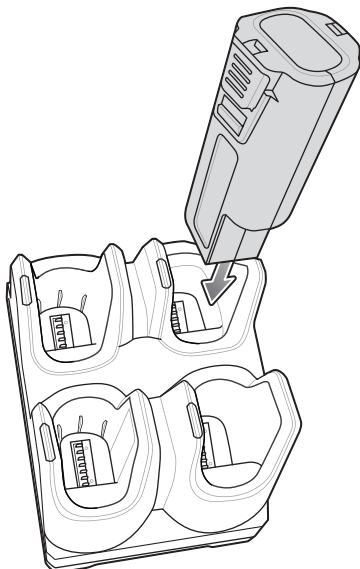


Figure 6-12 Insert Battery into Slot



## Battery Removal

To remove the battery, press the two release latches on each side of the battery and lift the battery out of the battery slot.

## Battery Charging

### Spare Battery Charging

Each Battery Charging LED indicates the status of the battery charging in each slot. The table below describes the Battery Charging LED status. The 6,700 mAh battery fully charges in less than four hours at room temperature.

**Table 6-7** *Battery Charging Indicators*

State	Indication
Off	Battery is not charging. It is not inserted correctly in the cradle or connected to a power source. Charger is not powered.
Solid Amber	Healthy battery is charging.
Solid Green	Healthy battery charging is complete.
Fast Blinking Red (2 blinks/second)	Charging error, e.g.: - Temperature is too low or too high. - Charging has gone on too long without completion (typically eight hours).
Solid Red	Unhealthy battery is charging or fully charged.

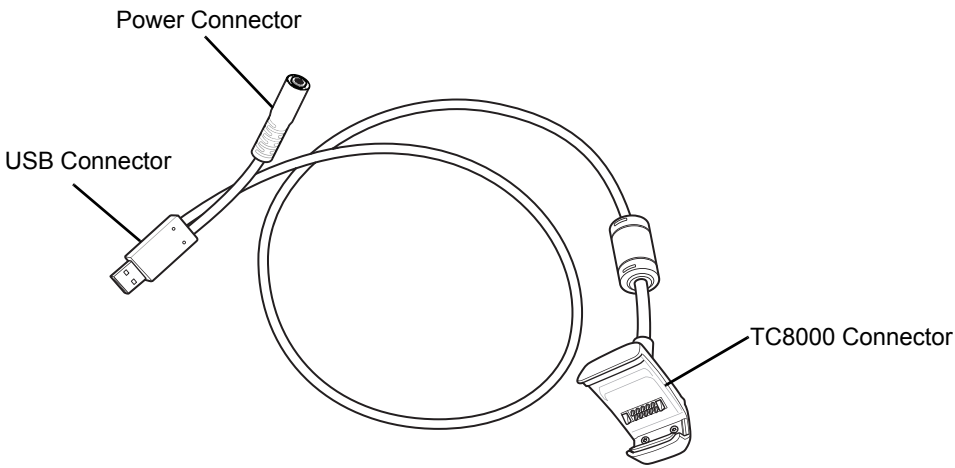
## Charging Temperature

Charge batteries in temperatures from 0 °C to 40 °C (32 °F to 104 °F). The battery charger always performs battery charging in a safe and intelligent manner. At higher temperatures (e.g. approximately +37 °C (+98 °F)) the battery charger may for small periods of time alternately enable and disable battery charging to keep the battery at acceptable temperatures. The battery charger indicates when charging is disabled due to abnormal temperatures via its LED.

## USB and Charging Cable

✓ **NOTE** Ensure that you follow the guidelines for battery safety described in *Battery Safety Guidelines* on page 7-1.

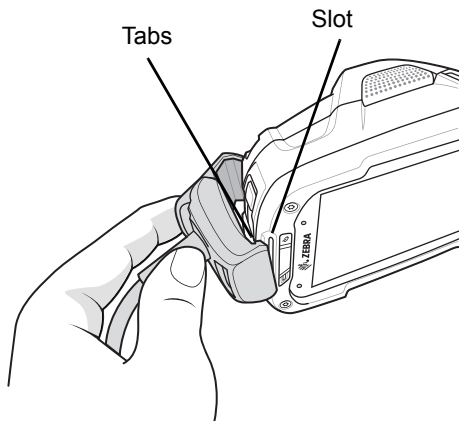
The USB and Charging cable snaps onto the top of the TC8000. When attached to the TC8000, allows the TC8000 to transfer data to a host computer and provide power for charging the TC8000.



**Figure 6-13** Snap-On USB Cable

### Attaching the USB and Charging Cable

1. Align the tabs on the Audio Adapter with the slots on the device.
2. Rotate the Adapter toward the back of the device until the adapter snaps onto the device.



**Figure 6-14** Attach Cable to TC8000

3. Attach the USB connection to the host computer.

## Removing the USB and Charging Cable

To remove the USB and Charging cable:

1. Press the release level toward the cable.
2. Rotate the adapter toward the front of the device and remove.

## Battery Charging

To charge the TC8000, attached the power cable to the Power Connection on the USB and Charging Cable.

### Main Battery Charging

The TC8000 Charging/Scan LED indicates the status of the battery charging in the device. See [Table 1-3 on page 1-10](#). The 6,700 mAh battery fully charges in less than four hours at room temperature.

## Charging Temperature

Charge batteries in temperatures from 0 °C to 40 °C (32 °F to 104 °F). The battery charger always performs battery charging in a safe and intelligent manner. At higher temperatures (e.g. approximately +37 °C (+98 °F)) the battery charger may for small periods of time alternately enable and disable battery charging to keep the battery at acceptable temperatures. The battery charger indicates when charging is disabled due to abnormal temperatures via its LED.

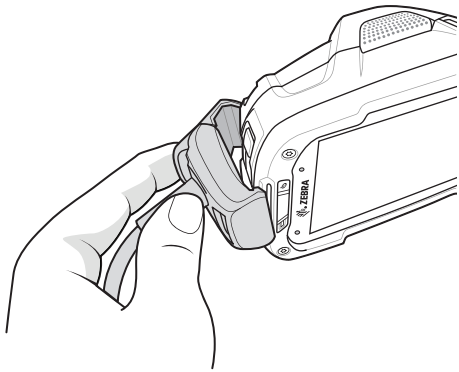
---

## Quick Disconnect Audio Adapter

The Quick Disconnect Audio Adapter snaps onto the top of the TC8000 and removes easily when not in use. When attached to the TC8000, the Quick Disconnect Audio Adapter allows a user to connect a wired headset to the TC8000.

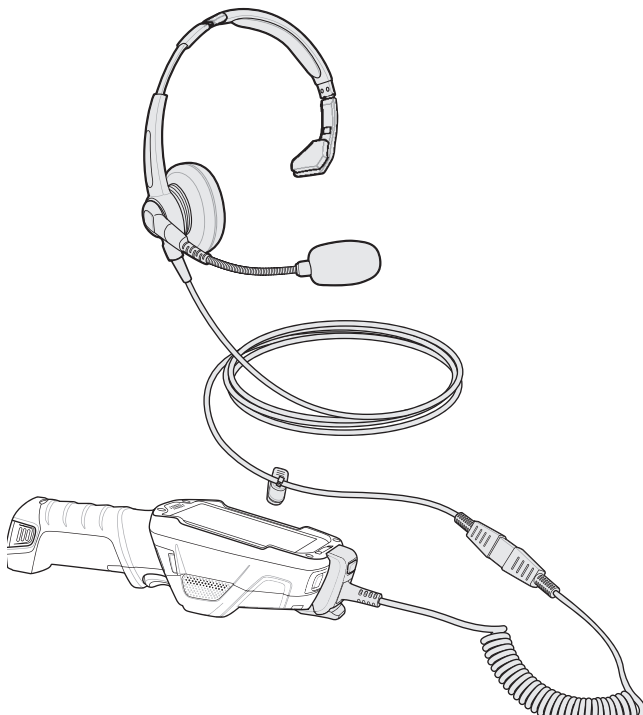
### Attaching the Audio Adapter

1. Align the tabs on the Audio Adapter with the slots on the device.
2. Rotate the Adapter toward the back of the device until the Adapter snaps onto the device.



**Figure 6-15** *Attach Cable to TC8000*

### Connecting the Adapter to a Headset



**Figure 6-16** *Quick Disconnect Audio Adapter Connection to Headset*

## Removing the Audio Adapter

To remove the Audio Adapter:

1. Press the release level toward the cable.
2. Rotate the adapter toward the front of the device and remove.

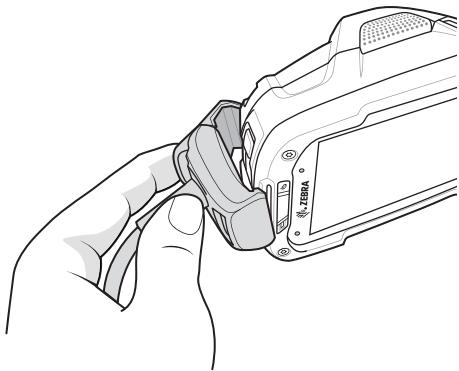
---

## 3.5 mm Audio Adapter

The 3.5 mm Audio Adapter snaps onto the top of the TC8000 and removes easily when not in use. When attached to the TC8000, the Audio Adapter allows a user to connect a wired 3.5 mm headset to the TC8000.

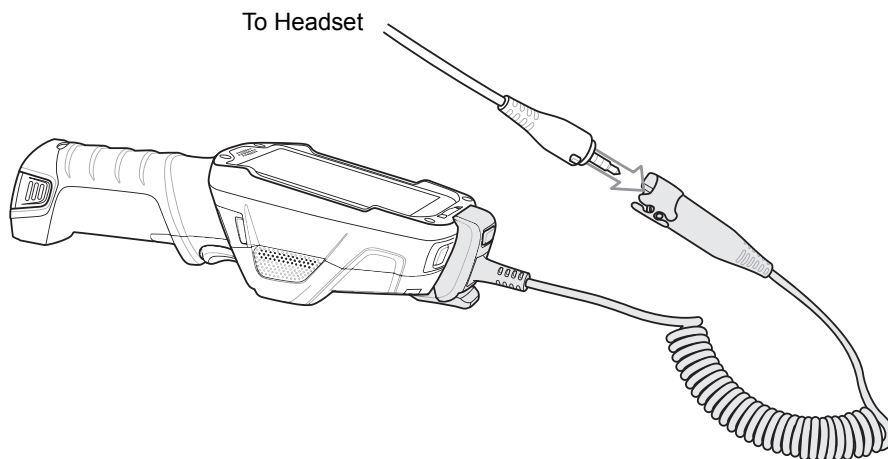
### Attaching the Audio Adapter

1. Align the tabs on the Audio Adapter with the slots on the device.
2. Rotate the Adapter toward the back of the device until the Adapter snaps onto the device.



**Figure 6-17** *Attach Cable to TC8000*

### Connecting the Adapter to a Headset



**Figure 6-18** *3.5 mm Audio Adapter Connection*

## Headset Recommendations

**Table 6-8** *Headset Recommendations*

Headset	Adapter Cable	Voice-Directed Picking	PTT (half duplex)	Voice Calls (full duplex)
Speakerphone mode	N/A	Not Supported	Y	Not Supported
RCH51	QD Adapter Cable CBL-TC8X-AUDQD-01	Y	Y	Y
HS2100 w/QD Cable	QD Adapter Cable CBL-TC8X-AUDQD-01	Y (Preferred)	Y	Y
HS2100 w/3.5 mm Cable	3.5 mm Adapter Cable CBL-TC8X-AUDBJ-01	Not Supported	Y	Y
Palm Garden Over the Ear Headset w/ MIC and PTT - 3.5 mm Cable HSDT-35MM-PTVP-01	3.5 mm Adapter Cable CBL-TC8X-AUDBJ-01	Not Supported	Y	Y

## Removing the Audio Adapter

To remove the Audio Adapter:

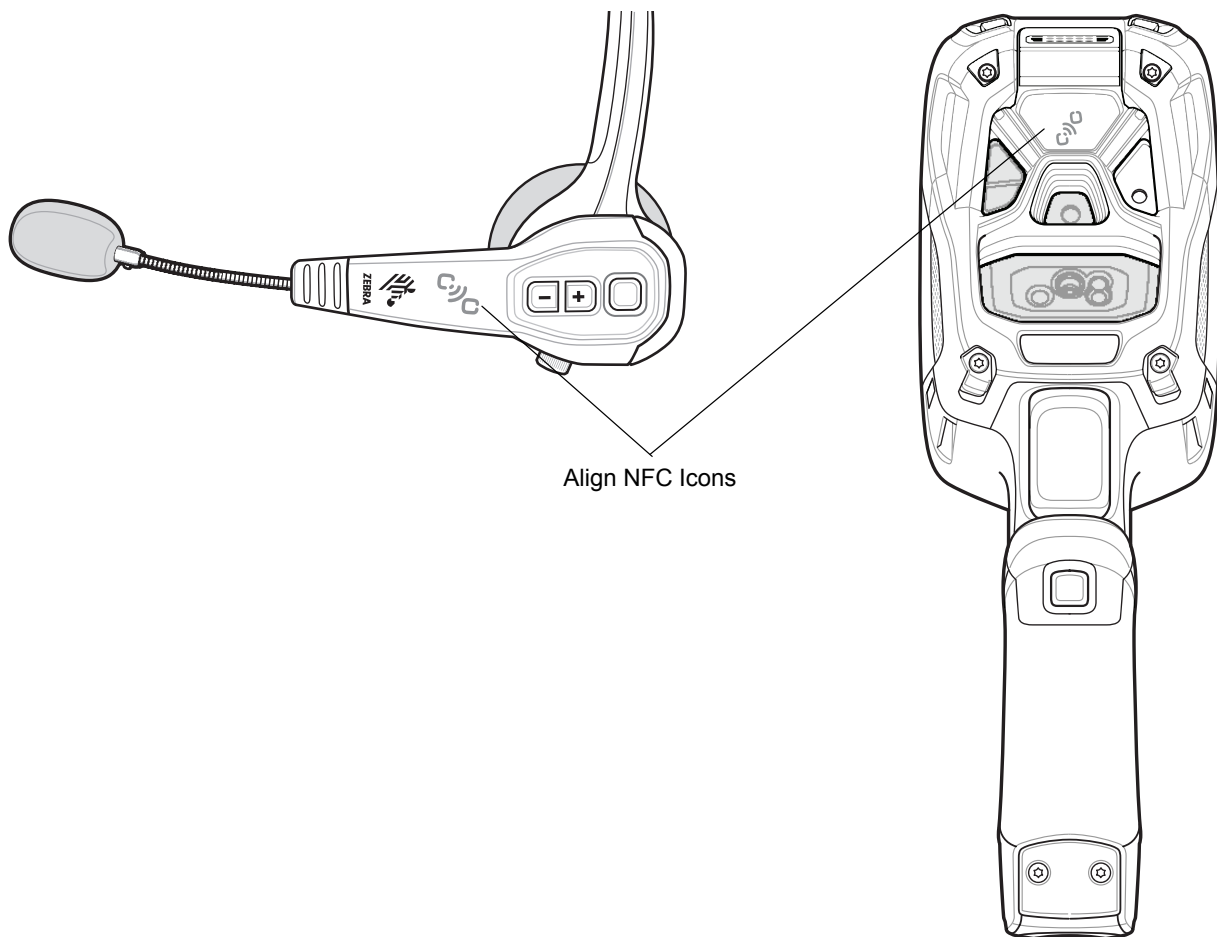
1. Press the release level toward the cable.
2. Rotate the adapter toward the front of the device and remove.

## Pairing the HS3100 Bluetooth Headset to the TC8000

### Pairing Using Near Field Communication

The TC8000 provides the ability to pair the HS3100 bluetooth headset using NFC.

1. Ensure that NFC is enabled on the TC8000.
2. Align the NFC icon on the HS3100 headset with the NFC icon on the TC8000. The headset LED turns solid blue and TC8000 displays a **Pairing Zebra HS3100** notification along with a notification tone which is followed by a **Connecting Zebra HS3100** notification and the headset LED starts blinking blue.



**Figure 6-19** *Align NFC Icons*

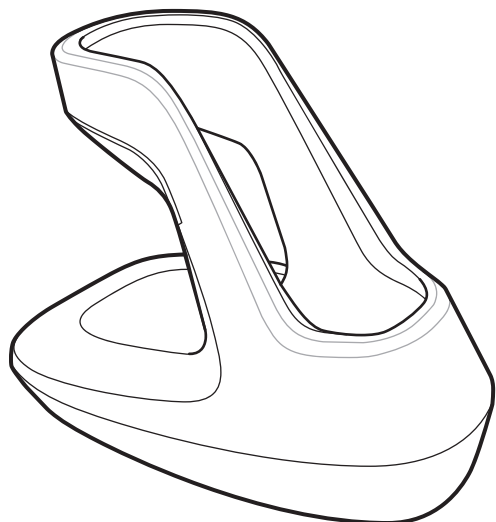
- ✓ **NOTE** On any subsequent NFC Tap-to-Pair, as long as the headset is in the Bluetooth device list, the TC8000 only displays a **Connecting Zebra HS3100** notification along with a notification tone.
- 3. With the HS3100 and the TC8000 connected, perform an NFC Tap-to-Pair and the headset will turn off and a **Disconnecting HS3100 headset** notification displays on the TC8000 along with a notification tone.
- ✓ **NOTE** Not all Zebra devices support NFC readers and the Tap-to-Pair feature.



---

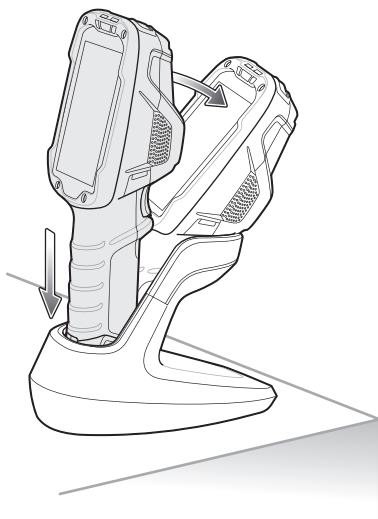
## Desktop Stand

The Desk Stand allows the user place the TC8000 in presentation mode for hands-free scanning.



**Figure 6-20** *Desktop Mount*

Place the handle into the Desk Mount base and then rotate forward.

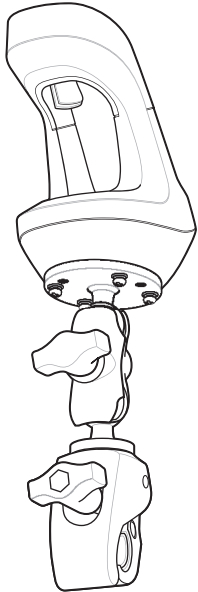


**Figure 6-21** *Insert TC8000 into Desktop Mount*

---

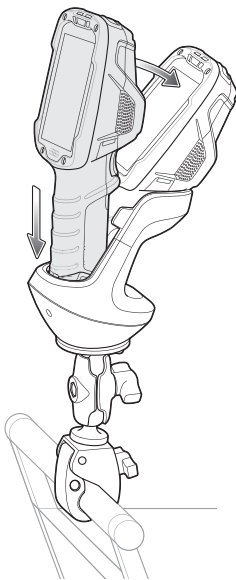
## Cart Mount

The Cart Mount allows the user place the TC8000 in presentation mode for hands-free scanning while installed on a cart.



**Figure 6-22** *Cart Mount*

Place the handle into the Cart Mount base and then rotate forward.



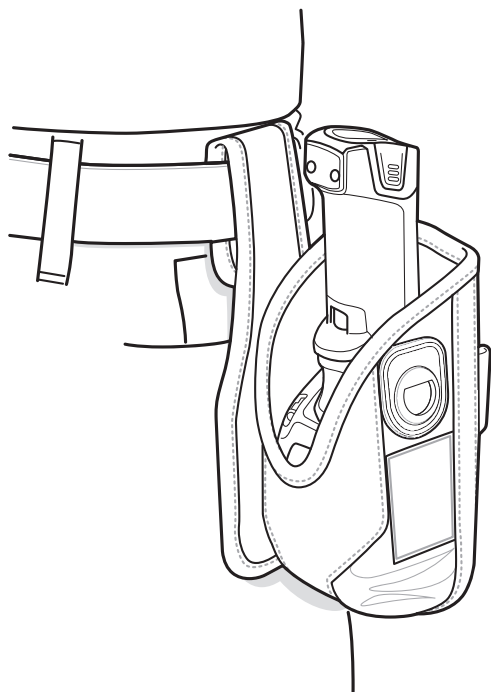
**Figure 6-23** *Insert TC8000 into Cart Mount*

See *TC8000 Integrator Guide* for assembly instructions.

---

## Quick-Draw Soft Holster

Use the Quick-Draw Soft Holster to store the TC8000 when not in use. The holster attaches to a belt and is reversible for wearing on either side of the body.



**Figure 6-24** *Quick-Draw Soft Holster*

---

## Presentation Holster

Use the Presentation Holster for hands-free scanning. Attach to optional shoulder strap or optional belt.



**Figure 6-25** *Presentation Holster with Shoulder Strap*



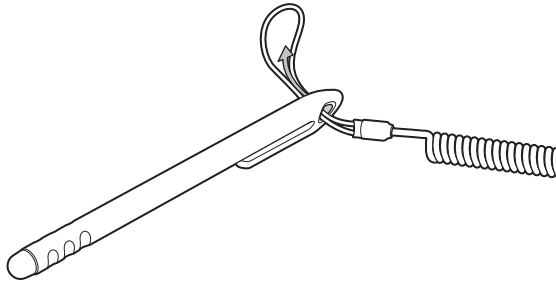
**Figure 6-26** *Presentation Holster on Belt*

---

## Stylus

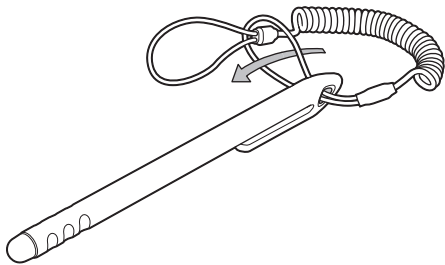
To install the stylus onto the hand strap:

1. Thread the loop of the tether through the hole in the stylus.



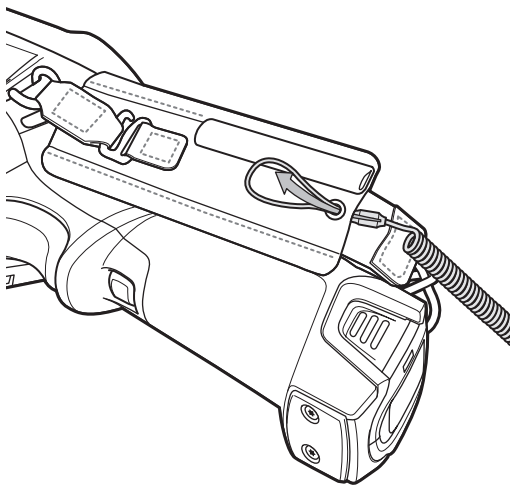
**Figure 6-27** Thread Loop through Stylus Hole

2. Thread the other end of the tether through the loop.



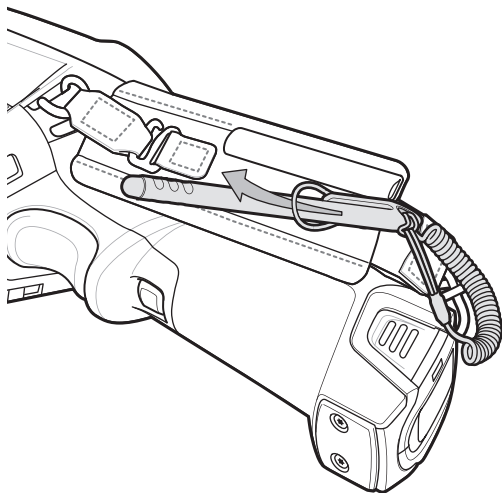
**Figure 6-28** Thread Tether through Loop

3. Insert the tether loop into the hand strap eyelet.



**Figure 6-29** Feed Loop through Hand Strap Eyelet

4. Feed the stylus through the tether loop.



**Figure 6-30** *Feed Stylus Through Loop*

5. Pull stylus through the loop and tighten.

# CHAPTER 7 MAINTENANCE AND TROUBLESHOOTING

---

## Introduction

This chapter includes instructions on cleaning and storing the TC8000, battery maintenance and provides troubleshooting solutions for potential problems during TC8000 operations.

---

## Maintaining the TC8000

For trouble-free service, observe the following tips when using the TC8000:

- Protect the TC8000 from temperature extremes.
- Do not store or use the TC8000 in any location that is extremely dusty, damp, or wet.
- Use a soft lens cloth to clean the scan exit window of the TC8000. If the surface of the TC8000 screen becomes soiled, clean it with a soft cloth moistened with a diluted window-cleaning solution. Do not use bleach or ammonia.
- Take care not to scratch the screen of the TC8000.
- The display of the TC8000 contains glass. Take care not to drop the TC8000 or subject it to strong impact.

---

## Battery Safety Guidelines

- The area in which the TC8000 units are charged should be clear of debris and combustible materials or chemicals. Particular care should be taken where the device is charged in a non-commercial environment.
- Do not use incompatible batteries and chargers. If you have any questions about the compatibility of a battery or a charger, contact Zebra Support. See *Service Information on page xvi* for contact information.
- Do not crush, puncture, or place a high degree of pressure on the battery.
- Follow battery usage, storage, and charging guidelines.
- Improper battery use may result in a fire, explosion, or other hazard.
- To charge the mobile device battery, the battery and charger temperatures must be between +32°F and +104°F (0°C and +40°C)

- Do not disassemble or open, crush, bend or deform, puncture, or shred.
- Severe impact from dropping any battery-operated device on a hard surface could cause the battery to overheat.
- Do not short circuit a battery or allow metallic or conductive objects to contact the battery terminals.
- Do not modify or remanufacture, attempt to insert foreign objects into the battery, immerse or expose to water or other liquids, or expose to fire, explosion, or other hazard.
- Do not leave or store the equipment in or near areas that might get very hot, such as in a parked vehicle or near a radiator or other heat source. Do not place battery into a microwave oven or dryer.
- Battery usage by children should be supervised.
- Please follow local regulations to promptly dispose of used re-chargeable batteries.
- Do not dispose of batteries in fire.
- Seek medical advice immediately if a battery has been swallowed.
- In the event of a battery leak, do not allow the liquid to come in contact with the skin or eyes. If contact has been made, wash the affected area with large amounts of water and seek medical advice.
- If you suspect damage to your equipment or battery, call Customer Support to arrange for inspection. See *Service Information on page xvi* for contact information.

---

## Long Term Storage

When storing the TC8000 for a long period of time, it is recommended to remove the battery.

When returning the TC8000 to everyday operation, install a fully charged battery.

---

## Cleaning



**CAUTION** Always wear eye protection.

Read warning label on compressed air and alcohol product before using.

If you have to use any other solution for medical reasons please contact Zebra for more information.



**WARNING!** Avoid exposing this product to contact with hot oil or other flammable liquids. If such exposure occurs, unplug the device and clean the product immediately in accordance with these guidelines.

## Materials Required

- Alcohol wipes
- Lens tissue
- Cotton tipped applicators
- Isopropyl alcohol
- Can of compressed air with a tube.



## Cleaning the TC8000

### Housing

Using the alcohol wipes, wipe the housing including the Scan key.

### Display

The display can be wiped down with the alcohol wipes, but care should be taken not to allow any pooling of liquid around the edges of the display. Immediately dried the display with a soft, non-abrasive cloth to prevent streaking.

### Scan Exit Window

Wipe the scan exit window periodically with a lens tissue or other material suitable for cleaning optical material such as eyeglasses.

### Power Connector

1. Remove the battery from TC8000.
2. Dip the cotton portion of the cotton tipped applicator in isopropyl alcohol.
3. Rub the cotton portion of the cotton tipped applicator back-and-forth across the connector inside the handle of the TC8000. Do not leave any cotton residue on the connector.
4. Repeat at least three times.
5. Use the cotton tipped applicator dipped in alcohol to remove any grease and dirt near the connector area.
6. Use a dry cotton tipped applicator and repeat steps 3 through 5.
7. Spray compressed air on the connector area by pointing the tube/nozzle about ½ inch away from the surface.



**CAUTION** Do not point nozzle at yourself and others, ensure the nozzle or tube is away from your face.

8. Inspect the area for any grease or dirt, repeat if required.

## Cleaning Cradle Connectors

Use this procedure to clean the connectors on a cradle:

1. Remove power from the cradle.
2. Dip the cotton portion of the cotton tipped applicator in isopropyl alcohol.
3. Rub the cotton portion of the cotton tipped applicator along the pins of the connector. Slowly move the applicator back-and-forth from one side of the connector to the other. Do not let any cotton residue on the connector.
4. All sides of the connector should also be rubbed with the cotton tipped applicator.
5. Spray compressed air in the connector area by pointing the tube/nozzle about ½ inch away from the surface.



**CAUTION** Do not point nozzle at yourself and others, ensure the nozzle or tube is pointed away from your face.

6. Ensure that there is no lint left by the cotton tipped applicator, remove lint if found.
7. If grease and other dirt can be found on other areas of the cradle, use lint free cloth and alcohol to remove.
8. Allow at least 10 to 30 minutes (depending on ambient temperature and humidity) for the alcohol to air dry before applying power to cradle.

If the temperature is low and humidity is high, longer drying time is required. Warm temperature and dry humidity requires less drying time.

### **Cleaning Frequency**

The cleaning frequency is up to the customer's discretion due to the varied environments in which the TC8000 units are used. They may be cleaned as frequently as required. However when used in dirty environments it may be advisable to periodically clean the scanner exit window to ensure optimum scanning performance.

## Troubleshooting

### TC8000

**Table 7-1** Troubleshooting the TC8000

Problem	Cause	Solution
TC8000 does not turn on.	Battery not charged.	Charge or replace the battery in the TC8000.
	Battery not installed properly.	Ensure battery is installed properly. See <i>Installing the Battery on page 1-8</i> .
	System crash.	Perform a soft reset. If the TC8000 still does not turn on, perform a hard reset. See <i>Resetting the TC8000 on page 2-19</i> .
Battery did not charge.	Battery failed.	Replace battery. If the TC8000 still does not operate, try a soft reset, then a hard reset. See <i>Resetting the TC8000 on page 2-19</i> .
	TC8000 removed from cradle before charging completed.	Insert the TC8000 into the cradle and begin charging. The battery fully charges in approximately four hours.
	Ambient temperature of the cradle is too warm or too cold.	The ambient temperature must be between 0 °C and 40 °C (32 °F and 104 °F).
During data communication, no data was transmitted, or transmitted data was incomplete.	TC8000 unplugged from host computer during communication.	Reconnect the programming cable to the host computer and re-transmit.
	Communication software was incorrectly installed or configured.	See system administrator.
TC8000 turns itself off.	TC8000 is inactive.	The TC8000 turns off after a period of inactivity. If the TC8000 is running on battery power, this period can be set to 15 seconds, 30 seconds, 1 minute, 2 minutes, 5 minutes, 10 minutes, or 30 minutes. Change the setting if you need a longer delay before the automatic shutoff feature activates.
	Battery is depleted.	Place the TC8000 in the cradle to re-charge the battery.
	Battery is not inserted properly.	Insert the battery properly (see <i>Installing the Battery on page 1-8</i> ).
	The TC8000's battery is low and it powers down to protect memory content.	Place the TC8000 in the cradle to re-charge the battery.

**Table 7-1** Troubleshooting the TC8000 (Continued)

Problem	Cause	Solution
A message appears stating that the TC8000 memory is full.	Too many files stored on the TC8000.	Delete unused memos and records. You can save these records on the host computer.
	Too many applications installed on the TC8000.	If you have installed additional applications on the TC8000, remove them to recover memory. See <i>TC8000 Integrator Guide</i> .
The TC8000 does not accept scan input.	Unreadable bar code.	Ensure the symbol is not defaced.
	Distance between scanner exit window and bar code is incorrect.	Move the TC8000 closer or further from the bar code to the proper scanning range.
	TC8000 is not programmed for the bar code.	Verify that the TC8000 can read the type of bar code being scanned (See <a href="#">Technical Specifications</a> ). Ensure that the bar code parameters are set properly for the bar code being scanned.
	TC8000 is not programmed to generate a beep.	Verify that a beep on a good decode is used. See <i>TC8000 Integrator Guide</i> for more information.
During USB data communications, no data was transmitted, or transmitted data was incomplete.	Incorrect cable connection.	See <a href="#">Chapter 6, Accessories</a> .
	Communications software is not installed or configured properly.	Perform setup as described in <a href="#">Chapter 6, Accessories</a> .

# APPENDIX A SPECIFICATIONS

## Technical Specifications

The following tables summarize the TC8000's intended operating environment and general technical hardware specifications.

**Table A-1** *Technical Specifications*

Item	Description
<b>Physical and Environmental Characteristics</b>	
Dimensions (H x L x W)	233 mm x 76 mm x 64 mm 9.17 in. x 3.0 in. x 2.52 in.
Weight	Standard: 490 g (17.3 oz) Premium: 500 g (17.6 oz)
Display	Color Transflective LCD, 4 in. diagonal, 480 x 800 pixels, 24 bits (16 million pixels), 400 Nits.
Touch Panel	Multi-Touch projected capacitive; fingertip (bare or gloved) input; conductive stylus supported (sold separately); Corning® Gorilla® Glass
Backlight	Configurable LED backlight control
Battery	PowerPrecision+ rechargeable 3.7 VDC 6,700 mAh Lithium-Ion battery.
Backup Power	Hot Swap backup
Expansion Slot	SDXC complaint microSD cards up to 32 GB (FAT32 format only).
Expansion Port	USB, Serial for ISV developers (optional)
Notification	Audible tone plus multi-color LEDs and vibration
Voice and Audio	Dual Speakers, Bluetooth wireless headset support
<b>Performance Characteristics</b>	
CPU	Dual-Core 1.7 GHz processor

**Table A-1** *Technical Specifications (Continued)*

Item	Description
Operating System	Android-based AOSP and GMS V5.1.X (Lollipop) with Mobility Extensions (Mx), for true enterprise class operating system.
Memory	1 GB RAM: Standard: 4 GB Flash (pSLC) Premium: 8 GB Flash (pSLC) 2 GB RAM: Premium: 16 GB Flash (pSLC)
Application Development	Zebra Android EMDK
<b>User Environment</b>	
Operating Temperature	-20° C to 50° C (-4° F to 122° F)
Storage Temperature	-40° C to 70° C (-40° F to 158° F)
Battery Charging Temperature	0° C to +40° C (32° F to 104° F) ambient temperature range.
Humidity	5% - 95% non-condensing
Drop Specification	Multiple 8 ft./2.4 m drop to concrete at room temperature per MIL-STD 810G; multiple 6 ft./1.8 m drop to concrete across full operating temperature range
Tumble	2,000 1 m (3.28 ft.) tumbles; meets and exceeds IEC tumble specifications
Sealing	IP65
Vibration	Sine 5-2000 Hz, 4 g peak, 1 hour per axis Random 20-2000 Hz, 6 g RMS or 0.04 g2/Hz, 1 hour per axis
ESD	± 20k VDC air discharge ± 10k VDC contact discharge ± 10k VDC indirect discharge
<b>Wireless LAN Data Communications</b>	
Radio	IEEE ® 802.11a/b/g/n/d/h/i
Data Rates	5 GHz: 802.11a/n - up to 150 Mbps; 2.4 GHz: 802.11b/g/n - up to 72.2 Mbps
Operating Channels	Channels 36 - 165 (5180 - 5825 MHz) Channels 1 - 13 (2412 - 2472 MHz) Actual operating channels/frequencies depend on regulatory rules and certification agency
Security and Encryption	WEP, WPA - TKIP, WPA2- TKIP, WPA2-TKIP AES EAP TTLS, PAP, MSCHAP, MSCHAP v2, PEAPv0-MSCHAPv2, PEAPv1- EAP-GTC, EAP-TLS, EAP-FAST, LEAP
Multimedia	Wi-Fi Multimedia™ (WMM)

**Table A-1** *Technical Specifications (Continued)*

Item	Description
Certifications	802.11n, WMM, WMM-PS, Cisco CCXv4, Wi-Fi Direct and Wi-Fi Display (Miracast).
Fast Roam	PMKID Caching, Opportunistic Key Caching (OKC), Cisco CCKM, 802.11r.
<b>Wireless PAN Data Communications</b>	
Bluetooth	Bluetooth 4.0 (Bluetooth Smart Technology)
USB	USB 2.0 Client for service and maintenance.
<b>Data Capture</b>	
Laser Scanning	SE965 1D standard range scan engine.
Imager	SE4750-SR Standard or SE4750-MR medium range next generation omnidirectional 1D/2D imaging engine. SE4850 Extended Range Imager
Camera	8MP Autofocus with flash, f/2.4 aperture (optional).
NFC	Multi-Protocol NFC (optional).
<b>Zebra Interactive Sensor Technology (IST)</b>	
Motion Sensor	3-axis accelerometer; 3-axis gyroscope (optional).
Light Sensor	Automatically adjusts display backlight.
Navigation	Digital Compass (optional).
Proximity	Sensor for auto hands-free scanning.

**Table A-2** *Data Capture Supported Symbolologies*

Item	Description
1D Bar Codes	Chinese 2 of 5, Codabar, Code 11, Code 128, Code 39, Code 93, Discrete 2 of 5, EAN-8, EAN-13, GS1 DataBar, GS1 DataBar 14, GS1 DataBar Expanded GS1, GS1 DataBar Limited, Interleaved 2 of 5, Korean 2 of 5, Matrix 2 of 5, MSI, TLC39, Trioptic 39, UPCA, UPCE, UPCE1
2D Bar Codes	Australian Postal, Aztec, Canadian Postal, Composite AB, Composite C, Data Matrix, Dutch Postal, HAN XIN, Japanese Postal, Mail Mark, Maxi Code, Micro PDF-417, microQR, PDF-417, QR Code, US Planet, UK Postal, US Postnet, USPS 4-state (US4CB), US4state FICS

## SE965 Standard Range Laser Decode Zones

The table below lists the typical distances for selected bar code densities. The minimum element width (or “symbol density”) is the width in mils of the narrowest element (bar or space) in the symbol.

**Table A-3** SE965 Decode Distances

Symbol Density/ Bar Code Type/ W-N Ratio	Bar Code Content/ Contrast <sup>Note 1</sup>	Typical Working Ranges	
		Near	Far
5.0 mil Code 128	1234 80% MRD	1.2 in 3.05 cm	7.7 in 19.56 cm
5.0 mil Code 39; 2.5:1	ABCDEFGH 80% MRD	1.2 in 3.05 cm	12.5 in 31.75 cm
7.5 mil Code 39; 2.5:1	ABCDEF 80% MRD	1.1 in 2.79 cm	18.5 in 46.99 cm
10 mil Code 128	1234 80% MRD	1.2 in <sup>Note 3</sup> 3.05 cm <sup>Note 3</sup>	19.0 in 48.26 cm
13 mil 100% UPC	12345678905 80% MRD	1.6 in 4.06 cm	27.0 in 68.58 cm
15 mil Code 128	1234 80% MRD	1.0 in <sup>Note 3</sup> 2.54 cm <sup>Note 3</sup>	29.5 in 74.93 cm
20 mil Code 39; 2.2:1	123 80% MRD	1.4 in <sup>Note 3</sup> 3.56 cm <sup>Note 3</sup>	52.0 in 132.08 cm
55 mil Code 39; 2.2:1	CD 80% MRD	3.4 in <sup>Note 3</sup> 8.64 cm <sup>Note 3</sup>	100.0 in 254.00 cm
100 mil Code 39; 3.0:1 reflective	123456 80% MRD	2 ft <sup>Note 3</sup> 60.96 cm <sup>Note 3</sup>	17 ft 518.16 cm

### Notes:

1. Contrast measured as Mean Reflective Difference (MRD) at 650 nm.
2. Working range specifications at ambient temperature (23°C), photographic quality symbols.  
Pitch=10°, roll=0°, skew=0°, ambient light < 150 ft-candles using Symbol or equivalent decoder.
3. Dependent on width of bar code.
4. Distances measured from front edge of scan engine chassis.



## SE4750-SR Decode Distances

The table below lists the typical distances for selected bar code densities.

**Table A-4** SE4750-SR Decode Distances

Symbol Density/ Bar Code Type	Typical Working Ranges	
	Near	Far
3 mil Code 39	2.8 in. 7.1 cm	6.2 in. 15.7 cm
5.0 mil Code 128	2.3 in. 5.8 cm	8.7 in. 22.0 cm
5 mil PDF417	3.0 in. 7.6 cm	8.1 in. 20.6 cm
6.67 mil PDF417	2.2 in. 5.6 cm	10.6 in. 26.9 cm
10 mil Data Matrix	2.4 in. 6.1 cm	10.6 in. 26.9 cm
100% UPCA	1.6* in. 4.1* cm	23.0 in. 58.4 cm
15 mil Code 128	2.4* in. 6.1* cm	25.2 in. 64.0 cm
20 mil Code 39	1.6* in. 4.1* cm	36.3 in. 92.2 cm

\* Limited by width of bar code in field of view.

Note: Photographic quality bar code at 18° tilt pitch angle under 30 fcd ambient illumination.  
Distances measured from front edge of scan engine chassis.

## SE4750-MR Decode Zones

The table below lists the typical distances for selected bar code densities.

**Table A-5** SE4750-MR Decode Distances

Symbology	Typical Working Range	
	Near	Far
5 mil Code 128	7.4 in. 18.8 cm	16.0 in. 40.6 cm
5 mil PDF417	8.1 in. 20.6 cm	13.1 in. 33.3 cm
7.5 mil Data Matrix	8.3 in. 21.1 cm	12.8 in. 32.5 cm
10 mil Data Matrix	7.0 in. 17.8 cm	17.0 in. 43.2 cm
13 mil UPCA	2.3* in. 5.8* cm	38.0 in. 96.5 cm
15 mil Code 128	4.0* in. 10.2* cm	40.0 in. 101.6 cm
20 mil Code 39	2.1* in. 5.3* cm	54.0 in. 137.2 cm
100 mil Code 39	11.0 in. 27.9 cm	172.0 in. 436.9 cm
160 mil Data Matrix	11.5 in. 29.2 cm	138.0 in. 350.5 cm

\* Limited by width of bar code in field of view.

Note: Photographic quality bar code at 18° tilt pitch angle under 30 fcd ambient illumination.  
Distances measured from front edge of scan engine chassis.

## SE4850 Decode Zones

The table below lists the typical distances for selected bar code densities.

### SE4850 Decode Distances

Symbology	Typical Working Range @20 Ft-Cd Minimum	
	Near	Far
10 mil Code 39	3.0 in. * 7.6 cm *	85.0 in. 215.9 cm
13 100% UPC	3.5 in. 8.9 cm	90.0 in. 228.6 cm
15 mil Code 128	6.0 in. * 15.2 cm *	100.0 in. 254.0 cm
20 mil Code 39	4.0 in. * 10.2 cm *	172.0 in. 436.9 cm
40 mil Code 39	6.0 in. * 15.2 cm *	340.0 in. ** 863.6 cm **
55 mil Code 39	7.0* in. * 17.8* cm *	430.0 in. ** 1092.2 cm **
100 mil Code 39 (paper)	20.0* in. * 50.8* cm *	700.0 in. ** 1778.0 cm **
100 mil Code 128 (reflective)	30.0 in. * 76.2 cm *	700.0 in. 1778.0 cm
DataMatrix 10	5.0 in. 12.7 cm	45.0 in. 114.3 cm
DataMatrix 55	5.0 in. 12.7 cm	250.0 in. 635.0 cm
15 mil Code 128 (4 in. wide)	8.0 in. * 20.3 cm *	100.0 in. 254.0 cm

\* Limited by width of bar code in field of view.

\*\* Range is reduced under low ambient light level.



# INDEX

## Numerics

2-D bar codes ..... 3-2

## A

accessories ..... 6-1  
airplane mode ..... 1-17  
albums ..... 5-14  
android version .....xiv  
application shortcuts ..... 2-7  
applock administrator ..... 2-13

## B

bar codes  
    two dimensional ..... 3-2  
battery charging temperature ..... A-2  
battery usage ..... 1-15  
browser ..... 2-10  
build number .....xiv  
bullets ..... xv

## C

calculator ..... 2-10  
calendar ..... 2-10  
camera settings ..... 5-6  
cleaning ..... 7-1  
clock ..... 2-11  
configuration ..... xii  
conventions  
    notational ..... xv  
CPU ..... A-1

## D

data capture  
    imager operational modes  
        decode mode ..... 3-2  
        pick list mode ..... 3-2  
    imaging ..... 3-2  
    two dimensional bar codes ..... 3-2  
datawedge ..... 2-11  
decode distances ..... A-4  
decode zones ..... A-6, A-7  
diagnostics ..... 5-10  
dimensions ..... A-1  
display .....xii, A-1  
downloads ..... 2-11  
drop specification ..... A-2  
DWDemo ..... 2-11

## E

EAP ..... 4-1  
Elemesz ..... 5-10  
email ..... 2-11

## F

feedback ..... i-xvi  
file browser ..... 2-11, 5-12  
finger usage ..... 1-19

## G

gallery ..... 2-11

## H

humidity ..... A-2

**I**

imager. See data capture, imaging  
 imaging ..... 3-2  
 information, service .....xvi

**K**

keyboard ..... 2-9

**L**

laser scanning ..... 3-2  
 LED indicators ..... 3-1  
 lithium-ion battery ..... 1-1  
 low battery notification ..... 1-16

**M**

maintenance ..... 7-1  
 memory ..... A-2  
 mobile computer  
     scanning ..... 3-1  
     starting ..... 1-10  
 model number .....xiv  
 multiuser administrator ..... 2-13

**N**

naming folders ..... 2-8

**O**

operating system ..... A-2  
 operating temperature ..... A-2

**P**

parts of the mobile computer ..... 1-1  
 PEAP-GTC ..... 4-1  
 PEAP-MSCHAPv2 ..... 4-1  
 photos ..... 5-2

**R**

recording videos ..... 5-4  
 rotate screen ..... 1-19  
 RS507 scanning ..... 3-7

**S**

scanning  
     angle ..... 3-3  
     imaging ..... 3-2

    range ..... 3-3  
 scanning considerations ..... 3-3  
 screen  
     Symbol splash screen ..... 1-10  
 screen rotation ..... 1-19  
 secure storage administrator ..... 2-13  
 serial number ..... xiv  
 service information ..... xvi  
 set date ..... 1-17  
 set time ..... 1-17  
 set time zone ..... 1-17  
 setting  
     camera ..... 5-6  
     video ..... 5-7  
 settings ..... 2-13  
 sound recorder ..... 2-13  
 starting the mobile computer ..... 1-10  
 storage temperature ..... A-2

**T**

TLS ..... 4-1  
 touch mode ..... 1-19  
 troubleshooting ..... 7-5  
 TTLS  
     TTLS-MSCHAP ..... 4-1  
     TTLS-MSCHAPv2 ..... 4-1  
     TTLS-PAP ..... 4-1

**U**

unpacking ..... 1-1

**V**

video settings ..... 5-7  
 videos ..... 5-2, 5-4

**W**

weight ..... A-1  
 WEP ..... 4-1  
 WLAN radio ..... A-2  
 WPA ..... 4-1





Zebra Technologies Corporation, Inc.  
3 Overlook Point  
Lincolnshire, IL 60069, U.S.A.  
<http://www.zebra.com>

© 2017 ZIH Corp and/or its affiliates. All rights reserved. ZEBRA and the stylized Zebra head are trademarks of ZIH Corp, registered in many jurisdictions worldwide. All other trademarks are the property of their respective owners.