



TC75



Touch Computer

User Guide for Version 5.1.1



TC75 USER GUIDE

MN-002888-02

Rev. A

April 2018

The products described in this document may include copyrighted computer programs. Laws in the United States and other countries preserve for certain exclusive rights for copyrighted computer programs. Accordingly, any copyrighted computer programs contained in the products described in this document may not be copied or reproduced in any manner without the express written permission.

No part of this document may be reproduced, transmitted, stored in a retrieval system, or translated into any language or computer language, in any form or by any means, without the prior written permission.

Furthermore, the purchase of our products shall not be deemed to grant either directly or by implication, estoppel or otherwise, any license under the copyrights, patents or patent applications, except for the normal non-exclusive, royalty-free license to use that arises by operation of law in the sale of a product.

Disclaimer

Please note that certain features, facilities, and capabilities described in this document may not be applicable to or licensed for use on a particular system, or may be dependent upon the characteristics of a particular mobile subscriber unit or configuration of certain parameters. Please refer to your contact for further information.

Revision History

Changes to the original guide are listed below:

Change	Date	Description
-01 Rev A	7/2016	Initial release.
-02 Rev. A	3/2018	Update approved cleaner active ingredients on page 210.

TABLE OF CONTENTS

Disclaimer	ii
Trademarks	ii
Revision History	iii

About This Guide

Introduction	i
Documentation Set	i
Configurations	i
Software Versions	ii
Chapter Descriptions	ii
Notational Conventions	iii
Icon Conventions	iii
Related Documents	iii
Service Information	iv

Chapter 1: Getting Started

Introduction	1-1
Unpacking	1-1
Features	1-2
Setup	1-4
Installing the SIM Card	1-4
Installing the SAM Card	1-5
Installing a microSD Card	1-6
Installing the Hand Strap and Battery	1-7
Installing the Battery	1-8
Charging the Battery	1-9
Charging Indicators	1-10
Google Account Setup	1-10
Replacing the Battery	1-10
Replacing the SIM or SAM Card	1-12
Replacing the microSD Card	1-15
Battery Management	1-16

Monitor Battery Usage	1-16
Low Battery Notification	1-17
Battery Optimization	1-17
Turning Off the Radios	1-17
Setting the Date and Time	1-18
Display Setting	1-18
Setting the Screen Brightness	1-18
Setting Screen Rotation	1-18
Setting Screen Timeout Setting	1-19
Setting Font Size	1-19
Setting Touch Key Light	1-19
Touch Mode	1-20
General Sound Setting	1-22
Sound	1-22
Notification	1-24
Wake-Up Sources	1-24

Chapter 2: Using the TC75

Introduction	2-1
Google Mobile Services	2-1
Home Screen	2-2
Status Bar	2-3
Status Icons	2-3
Notification Icons	2-5
Managing Notifications	2-6
Quick Settings	2-7
Application Shortcuts and Widgets	2-8
Adding an Application or Widget to the Home Screen	2-8
Moving Items on the Home Screen	2-9
Removing an App or Widget from the Home Screen	2-9
Folders	2-9
Creating a Folder	2-9
Naming Folders	2-9
Removing a Folder	2-10
Home Screen Wallpaper	2-10
Changing the Home Screen Wallpaper	2-10
Using the Touchscreen	2-10
Using the On-screen Keyboard	2-11
Editing Text	2-11
Entering Numbers, Symbols and Special Characters	2-11
Applications	2-11
Accessing Applications	2-15
Switching Between Recent Applications	2-16
Un-Locking the Screen	2-17
Single User Mode	2-17
MultiUser Mode	2-21
MultiUser Login	2-21
MultiUser Logout	2-22
Resetting the Device	2-22

Performing a Soft Reset	2-22
Performing a Hard Reset	2-23
Suspend Mode	2-23

Chapter 3: Calls

Introduction	3-1
Emergency Calling	3-1
Audio Modes	3-1
Using a Bluetooth Headset	3-1
Using a Wired Headset	3-2
Adjusting Audio Volume	3-2
Making a Call Using the Dialer	3-2
Dialer Dialing Options	3-5
Making a Call Using Contacts	3-6
Using the Dialer	3-6
Using the Contacts application	3-6
Making a Call Using Call History	3-8
Making a Conference Call	3-9
Making a Call Using a Bluetooth Headset	3-12
Answering Calls	3-13
Call Settings	3-14
General settings	3-15
Call settings	3-15

Chapter 4: Applications

Introduction	4-1
Battery Manager	4-1
File Browser	4-3
Messaging	4-5
Sending a Text Message	4-5
Sending a Multimedia Message	4-5
Contacts	4-7
Adding Contacts	4-7
Editing People	4-7
Deleting People	4-7
Camera	4-8
Taking Photos	4-8
Taking a Panoramic Photo	4-10
Recording Videos	4-11
Photo Settings	4-13
Rear Camera	4-13
Front Camera	4-15
Video Settings	4-15
Rear Camera	4-15
Front Camera	4-16
Gallery	4-17
Working with Albums	4-18
Share an Album	4-18

Get Album Information	4-18
Deleting an Album	4-19
Working with Photos	4-19
Viewing and Browsing Photos	4-19
Cropping a Photo	4-20
Setting a Photo as a Contact Icon	4-20
Share a Photo	4-21
Deleting a Photo	4-21
Working with Videos	4-21
Watching Videos	4-21
Sharing a Video	4-22
Deleting a Video	4-22
DataWedge Demonstration	4-23
Sound Recorder	4-25
PTT Express Voice Client	4-26
PTT Audible Indicators	4-26
Notification Icons	4-27
Enabling PTT Communication	4-28
Selecting a Talk Group	4-28
PTT Communication	4-28
Creating a Group Call	4-29
Disabling PTT Express Voice Client Communication	4-29
MLog Manager	4-30
SimulScan Demo	4-31
Exporting Sample Forms	4-31
Postal, Transportation and Logistics Example	4-32
Manufacturing Example	4-34
Settings	4-36
Advanced Settings	4-37
Demo Customization	4-38
Default Templates	4-39
RxLogger	4-40
Elemex	4-41
Disabling Elemex Data Collection	4-41
Enabling Elemex Data Collection	4-42

Chapter 5: Data Capture

Introduction	5-1
Imaging	5-1
Operational Modes	5-1
Digital Camera	5-2
RS507 Hands-Free Imager	5-2
Scanning Considerations	5-2
Imager Scanning	5-3
Bar Code Capture with Integrated Camera	5-4
Bar Code Capture with RS507 Hands-Free Imager	5-5
Pairing the RS507 Hands-Free Imager Using SSI	5-6
Pairing the RS507 Hands-Free Imager Bluetooth HID	5-7
DataWedge	5-8

Enabling DataWedge	5-8
Disabling DataWedge	5-8

Chapter 6: Wireless

Introduction	6-1
Wireless Wide Area Networks	6-1
Sharing the Mobile Data Connection	6-1
USB Tethering	6-2
Bluetooth Tethering	6-2
Portable Wi-Fi Hotspot	6-2
Data Usage	6-3
Set Data Usage Warning	6-5
Set Auto-Sync	6-5
Disabling Data When Roaming	6-5
Limiting Data Connection to 2G Networks	6-5
Locking the SIM Card	6-5
Editing the Access Point Name	6-6
Wireless Local Area Networks	6-7
Scan and Connect to a Wi-Fi Network	6-7
Configuring a Wi-Fi Network	6-9
Manually Adding a Wi-Fi Network	6-11
Configuring for a Proxy Server	6-12
Configuring the Device to Use a Static IP Address	6-12
Advanced Wi-Fi Settings	6-13
Additional Settings	6-14
Remove a Wi-Fi Network	6-16
Bluetooth	6-16
Adaptive Frequency Hopping	6-17
Security	6-17
Bluetooth Profiles	6-18
Bluetooth Power States	6-18
Bluetooth Radio Power	6-18
Enabling Bluetooth	6-18
Disabling Bluetooth	6-19
Discovering Bluetooth Device(s)	6-19
Changing the Bluetooth Name	6-19
Connecting to a Bluetooth Device	6-20
Selecting Profiles on the Bluetooth Device	6-20
Unpairing a Bluetooth Device	6-20
Near Field Communications	6-20
Enabling NFC	6-22
Disabling NFC	6-22
Reading NFC Cards	6-22
Sharing Information Using NFC	6-23
Enterprise NFC Settings	6-23
Reader Mode	6-24

Chapter 7: Accessories

Introduction	7-1
Accessories	7-1
2-Slot Charge Only Cradle	7-5
Charging the Device	7-5
Charging the Spare Battery	7-6
Battery Charging	7-7
Main Battery Charging	7-7
Spare Battery Charging	7-7
Charging Temperature	7-7
2-Slot USB/Ethernet Cradle	7-8
Charging the Device	7-8
Charging the Spare Battery	7-9
Battery Charging	7-10
Main Battery Charging	7-10
Spare Battery Charging	7-10
Charging Temperature	7-11
USB/Ethernet Communication	7-11
Ethernet LED Indicators	7-11
Establishing Ethernet Connection	7-12
5-Slot Charge Only Cradle	7-13
Charging the TC75	7-13
Battery Charging	7-15
Main Battery Charging	7-15
Spare Battery Charging	7-15
Charging Temperature	7-15
5-Slot Ethernet Cradle	7-16
Charging the TC75	7-17
Battery Charging	7-19
Main Battery Charging	7-19
Spare Battery Charging	7-19
Charging Temperature	7-20
Establishing Ethernet Connection	7-20
LED Indicators	7-20
4-Slot Battery Charger	7-21
Charging Spare Batteries	7-21
Battery Charging	7-21
Spare Battery Charging	7-21
Charging Temperature	7-22
Magnetic Stripe Reader	7-23
Attaching the MSR	7-23
Removing the MSR	7-23
Reading Magnetic Stripe Cards	7-24
2.5 mm Audio Adapter	7-26
Attaching the 2.5 mm Audio Adapter	7-26
Connecting a Headset to the Audio Adapter	7-27
Device with Audio Adapter in Holster	7-27
Removing the 2.5 mm Audio Adapter	7-28
3.5 mm Audio Adapter	7-29
Connecting a Headset to the 3.5 mm Audio Adapter	7-29

Attaching the 3.5 mm Audio Adapter	7-30
Device with 3.5 mm Audio Adapter in Holster	7-30
Removing the 3.5 mm Audio Adapter	7-30
Snap-On USB Cable	7-32
Connecting to TC75	7-32
USB Communication	7-32
Charging the TC75	7-33
Disconnecting from TC75	7-33
Battery Charging	7-34
Main Battery Charging	7-34
Charging Temperature	7-34
Charging Cable Cup	7-35
Charging the TC75	7-35
Battery Charging	7-36
Main Battery Charging	7-36
Charging Temperature	7-36
Snap-On DEX Cable	7-36
Connecting to TC75	7-36
DEX Communication	7-37
Disconnecting from TC75	7-37
Trigger Handle	7-39
Installing the Trigger Handle Plate	7-39
Inserting the Device into the Trigger Handle	7-40
Removing the Device from the Trigger Handle	7-41
Vehicle Charging Cable Cup	7-42
Charging the TC75	7-42
Battery Charging	7-44
Main Battery Charging	7-44
Charging Temperature	7-44
Vehicle Cradle	7-44
TC75 Insertion and Removal	7-45
Battery Charging	7-47

Chapter 8: Maintenance and Troubleshooting

Introduction	8-1
Maintaining the TC75	8-1
Battery Safety Guidelines	8-1
Cleaning Instructions	8-2
Approved Cleanser Active Ingredients	8-2
Harmful Ingredients	8-3
Cleaning Instructions	8-3
Special Cleaning Notes	8-3
Cleaning Materials Required	8-3
Cleaning Frequency	8-3
Cleaning the TC75	8-4
Housing	8-4
Display	8-4
Camera and Exit Window	8-4
Connector Cleaning	8-4

Cleaning Cradle Connectors	8-4
Troubleshooting	8-6
TC75	8-6

Appendix A: Technical Specifications

Introduction	A-1
TC75	A-1

ABOUT THIS GUIDE

Introduction

This guide provides information about using the TC75 mobile computer and accessories.



NOTE Screens and windows pictured in this guide are samples and can differ from actual screens.

Documentation Set

The documentation set for the TC75 provides information for specific user needs, and includes:

- *TC75 Quick Start Guide* - describes how to get the TC75 up and running.
- *TC75 User Guide* - describes how to use the TC75.
- *TC75 Integrator Guide* - describes how to set up the TC75 and accessories.

Configurations



This guide covers the following configurations:

Configuration	Radios	Display	Memory	Data Capture Options	Operating System
TC75AH Professional (without Google Mobile Services (GMS))	WWAN: LTE WLAN: 802.11 a/b/g/n/d/h/i/k/r WPAN: Bluetooth v4.0 Low Energy	4.7" High Definition (1280 x 720) LCD	1 GB RAM / 8 GB Flash (SLC High Reliability Flash)	2D imager and integrated NFC	Android-based, Android Open-Source Project 5.1.1.
TC75BH Professional (without Google Mobile Services (GMS))	WWAN: HSPA+ WLAN: 802.11 a/b/g/n/d/h/i/k/r WPAN: Bluetooth v4.0 Low Energy	4.7" High Definition (1280 x 720) LCD	1 GB RAM / 8 GB Flash (SLC High Reliability Flash)	2D imager and integrated NFC	Android-based, Android Open-Source Project 5.1.1.
TC75AH Standard (with GMS)	WWAN: LTE WLAN: 802.11 a/b/g/n/d/h/i/k/r WPAN: Bluetooth v4.0 Low Energy	4.7" High Definition (1280 x 720) LCD	1 GB RAM / 8 GB Flash (SLC High Reliability Flash)	2D imager and integrated NFC	Android-based, Android Open-Source Project 5.1.1 with GMS.
TC75BH Standard (with GMS)	WWAN: HSPA+ WLAN: 802.11 a/b/g/n/d/h/i/k/r WPAN: Bluetooth v4.0 Low Energy	4.7" High Definition (1280 x 720) LCD	1 GB RAM / 8 GB Flash (SLC High Reliability Flash)	2D imager and integrated NFC	Android-based, Android Open-Source Project 5.1.1 with GMS.

Software Versions

To determine the current software versions touch  >  **About phone**.

- **Model number**- Displays the model number.
- **Android version** - Displays the operating system version.
- **Kernel version** - Displays the kernel version number.
- **Build number** - Displays the software build number.

To determine the device serial number touch  >  **About phone** > **Status**.

- **Serial number** - Displays the serial number.

Chapter Descriptions

Topics covered in this guide are as follows:

- [Chapter 1, Getting Started](#) provides information on getting the TC75 up and running for the first time.
- [Chapter 2, Using the TC75](#) provides information for operating the TC75.
- [Chapter 3, Calls](#) provides instructions for making phone calls.
- [Chapter 4, Applications](#) provides information on using applications installed on the TC75.
- [Chapter 5, Data Capture](#) provides information for capturing bar code data using the imager.
- [Chapter 6, Wireless](#) provides information on the various wireless options.

- [Chapter 7, Accessories](#) provides information for using the accessories for the TC75.
- [Chapter 8, Maintenance and Troubleshooting](#) includes instructions on cleaning and provides troubleshooting solutions for potential problems during TC75 operation.
- [Appendix A, Technical Specifications](#) provides the technical specifications for the TC75.

Notational Conventions

The following conventions are used in this document:

- *Italics* are used to highlight the following:
 - Chapters and sections in this and related documents
 - Icons on a screen.
- **Bold** text is used to highlight the following:
 - Dialog box, window, and screen names
 - Drop-down list and list box names
 - Check box and radio button names
 - Button names on a screen.
- Bullets (•) indicate:
 - Action items
 - Lists of alternatives
 - Lists of required steps that are not necessarily sequential
- Sequential lists (for example, lists that describe step-by-step procedures) appear as numbered lists.

Icon Conventions

The documentation set is designed to give the reader more visual clues. The following graphic icons are used throughout the documentation set. These icons and their associated meanings are described below.



WARNING! The word **WARNING** with the associated safety icon implies information that, if disregarded, could result in death or serious injury, or serious product damage.



CAUTION The word **CAUTION** with the associated safety icon implies information that, if disregarded, may result in minor or moderate injury, or serious product damage.



NOTE NOTE contains information more important than the surrounding text, such as exceptions or preconditions. They also refer the reader elsewhere for additional information, remind the reader how to complete an action (when it is not part of the current procedure, for instance), or tell the reader where something is located on the screen. There is no warning level associated with a note.

Related Documents

- *TC75 Quick Start Guide*, p/n MN001727Axx.

- *TC75 Regulatory Guide*, p/n MN001704Axx.
- *TC75 Integrator Guide*, p/n MN001975Axx.

For the latest version of this guide and all guides, go to: <http://www.zebra.com/support>.

Service Information

If you have a problem with the equipment, contact Customer Support in the region. Contact information is available at: <http://www.zebra.com/support>.

When contacting support, please have the following information available:

- Serial number of the unit (found on manufacturing label)
- Model number or product name (found on manufacturing label)
- Software type and version number

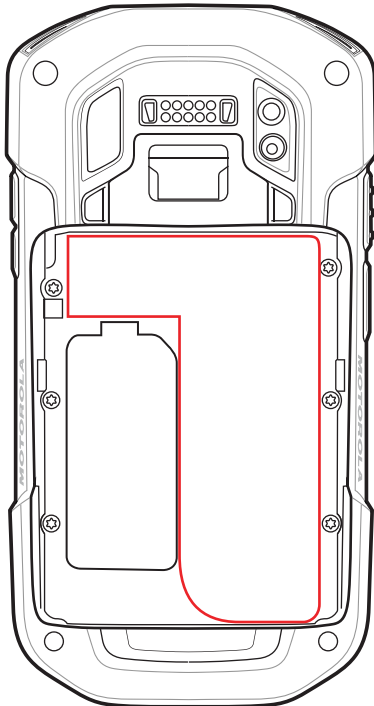

Customer Support responds to calls by email or telephone within the time limits set forth in support agreements.

If the problem cannot be solved by Customer Support, the user may need to return the equipment for servicing and will be given specific directions. We are not responsible for any damages incurred during shipment if the approved shipping container is not used. Shipping the units improperly can possibly void the warranty. Remove the SIM card and/or microSD card from the device before shipping for service.

If the device was purchased from a business partner, contact that business partner for support.

CHAPTER 1 GETTING STARTED

Introduction

This chapter provides information for getting the device up and running for the first time.

Unpacking

1. Carefully remove all protective material from the TC75 and save the shipping container for later storage and shipping.
2. Verify that the following were received:
 - TC75 mobile computer
 - 4,620 mAh Lithium-ion battery
 - Hand strap
 - Regulatory Guide
 - Quick Start Guide.
3. Inspect the equipment for damage. If any equipment is missing or damaged, contact the Global Customer Support center immediately.
4. Prior to using the TC75 for the first time, remove the protective shipping film that covers the scan window, display and camera window.

Features

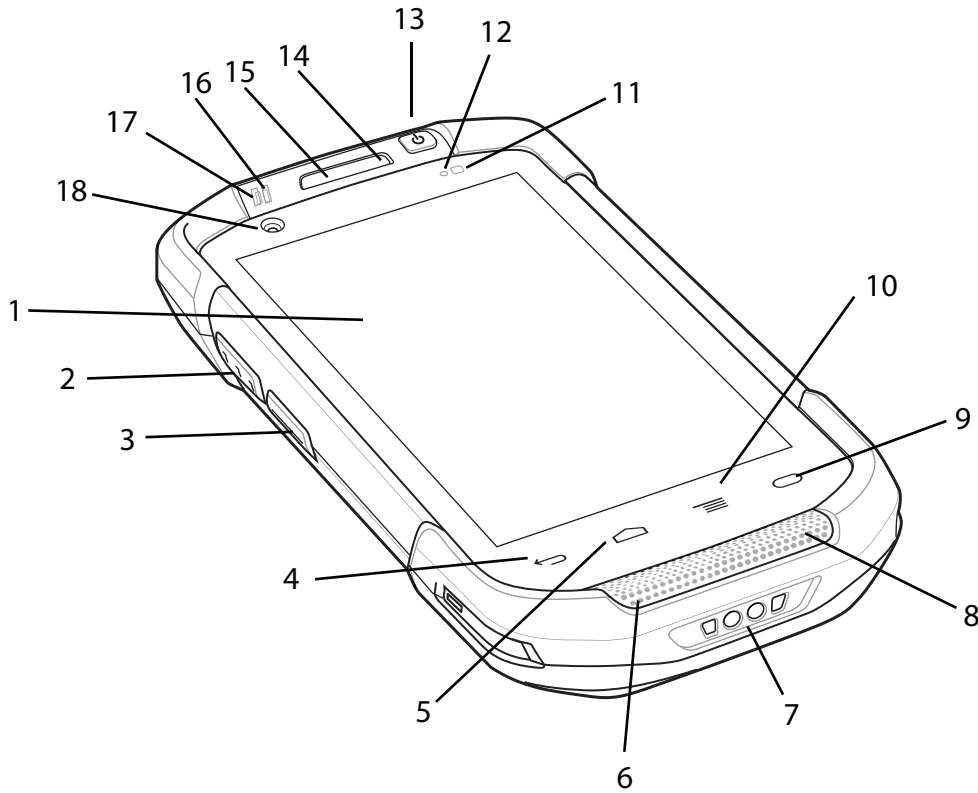

Figure 1-1 TC75 Front View

Table 1-1 Front View Features

Number	Item	Function
1	Touch Screen	Displays all information needed to operate the TC75.
2	Scan Button	Initiates data capture (programmable).
3	PTT Button	Initiates push-to-talk communications (programmable).
4	Back Button	Displays the previous screen.
5	Home Button	Displays the Home screen with a single press. Displays recently used applications when held for a short period of time. On TC75 with GMS, opens the Google Now screen when held for a short period of time.
6	Microphone	Use for communications in Handset mode.
7	Charging Contacts	Provides power to the device from cables and cradles.
8	Speaker	Provides audio output for video and music playback. Provides audio in speakerphone mode.

Table 1-1 Front View Features (Continued)

Number	Item	Function
9	Search Button	Opens the search application (programmable). On TC75 with GMS, opens the Recent App screen.
10	Menu Button	Opens a menu with items that affect the current screen or application.
11	Light Sensor	Determines ambient light for controlling display backlight intensity.
12	Proximity Sensor	Determines proximity for turning off display when in handset mode.
13	Power Button	Turns the display on and off. Press and hold to reset the device or power off.
14	Microphone	Use for communications in Speakerphone mode.
15	Receiver	Use for audio playback in Handset mode.
16	Charging/Notification LED	Indicates battery charging status while charging and application generated notifications.
17	Data Capture LED	Indicates data capture status.
18	Front Facing Camera	Use to take photos and videos.

**Figure 1-2** TC75 Rear View

Table 1-2 Back View Features

Number	Item	Function
19	Interface Connector	Provides USB host and client communications, audio and device charging via cables and accessories.
20	Exit Window	Provides data capture using the imager.
21	Microphone	Use during video recording and for noise cancellation.
22	Volume Up/Down Button	Increase and decrease audio volume (programmable).
23	Battery Release Latches	Press to remove the battery.
24	Elastic Sleeve	Use to hold optional stylus.
25	Battery	Provides power to the device.
26	Hand strap	Use to securely hold the device in your hand.
27	Hand strap Mounting Point	Provides latching point for the hand strap.
28	Camera	Takes photos and videos.
29	Camera Flash	Provides illumination for the camera.

Setup

Perform this procedure to start using the TC75 for the first time.

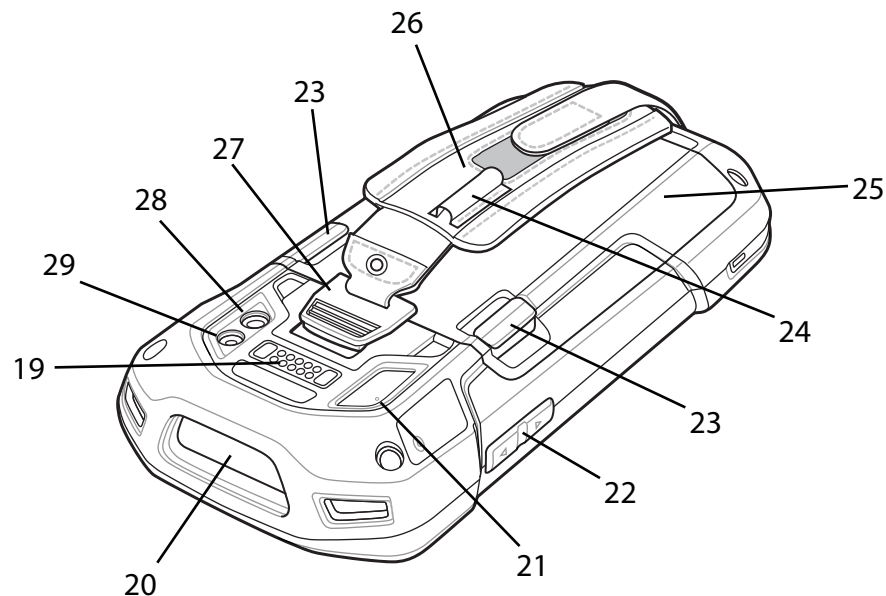
1. Install a SIM card.
2. Install a micro secure digital (SD) card (optional).
3. Install hand strap (optional).
4. Install the battery.
5. Charge the TC75.
6. Power on the TC75.

Installing the SIM Card



CAUTION For proper electrostatic discharge (ESD) precautions to avoid damaging the SIM card. Proper ESD precautions include, but not limited to, working on an ESD mat and ensuring that the user is properly grounded.



NOTE The TC75 may contain one mini SIM slot and two nano SIM slots. If using a micro SIM card, a third-party SIM adapter is required. By default, use a nano SIM card in slot 1.

1. Remove access cover.

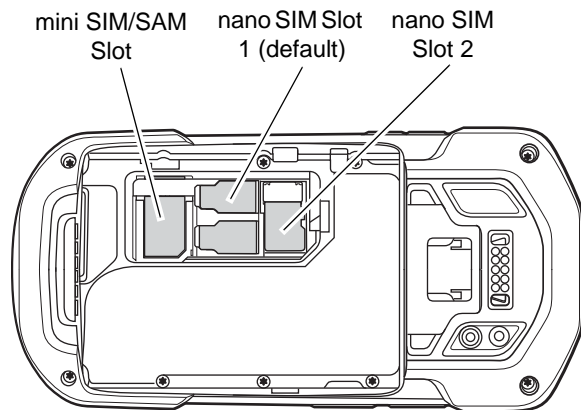

Figure 1-3 SIM Slot Locations

2. Insert a SIM card into the SIM slot with the cut edge toward the middle of the device and the contacts facing down.

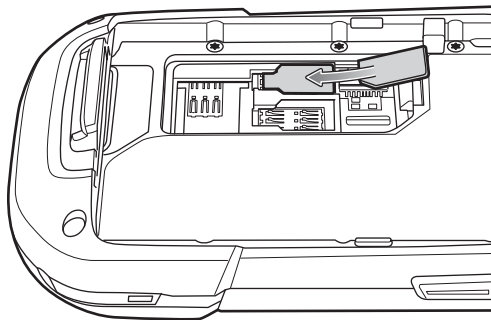

Figure 1-4 nano SIM Card Installation

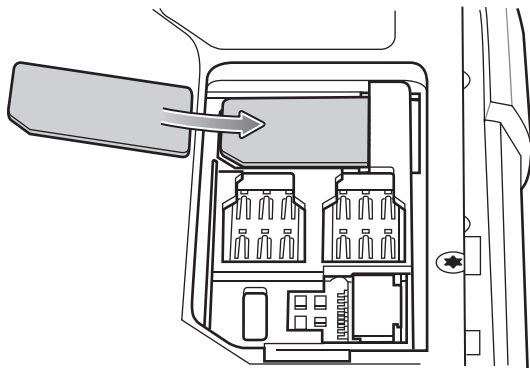

Figure 1-5 Mini SIM Card Installation

3. Ensure that the SIM card is seated properly.

Installing the SAM Card



CAUTION For proper electrostatic discharge (ESD) precautions to avoid damaging the Secure Access Module (SAM) card. Proper ESD precautions include, but not limited to, working on an ESD mat and ensuring that the user is properly grounded.

- ✓ **NOTE** The TC75 contains one slot for a mini SAM card. If using a micro SAM card, a third-party adapter is required. When using a SAM card, only a nano SIM card can be used.

1. Remove access cover.
2. Insert a SAM card into the SAM slot with the cut edge toward the middle of the device and the contacts facing down.

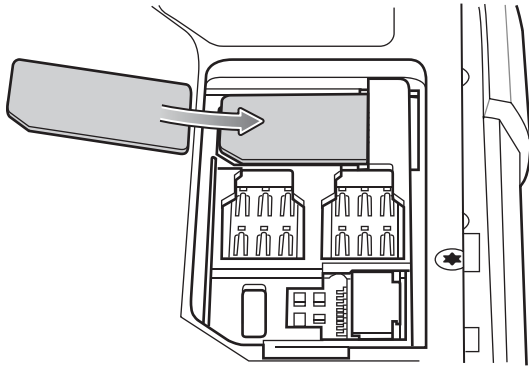

Figure 1-6 SAM Card Installation

3. Ensure that the SAM card is seated properly.

Installing a microSD Card

The microSD card slot provides secondary non-volatile storage. The slot is located under the battery pack. Refer to the documentation provided with the card for more information, and follow the manufacturer's recommendations for use.



CAUTION Follow proper electrostatic discharge (ESD) precautions to avoid damaging the microSD card. Proper ESD precautions include, but are not limited to, working on an ESD mat and ensuring that the operator is properly grounded.

1. Remove the hand strap, if installed.
2. Lift the access door.

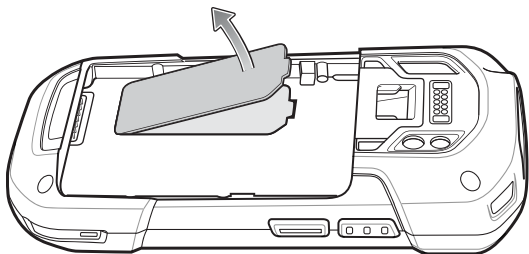

Figure 1-7 Lift Access Door

3. Insert the microSD card into the card holder door ensuring that the card slides into the holding tabs on each side of the door.

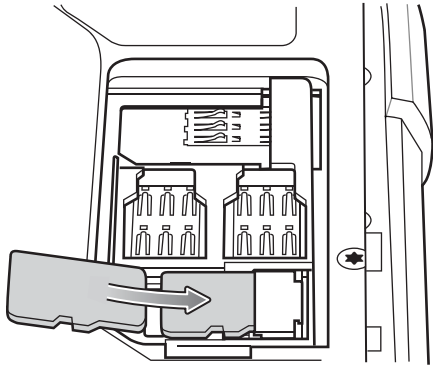

Figure 1-8 *Insert microSD Card in Holder*

4. Re-install the access door.

Installing the Hand Strap and Battery

✓ **NOTE** Installation of the hand strap is optional. Skip this section if not installing the hand strap.

1. Remove the hand strap filler from the hand strap slot. Store the hand strap filler in a safe place for future replacement.

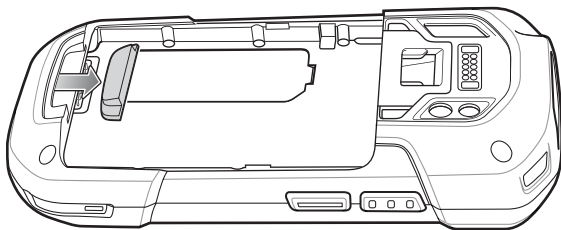

Figure 1-9 *Remove Filler*

2. Insert the hand strap plate into the hand strap slot.

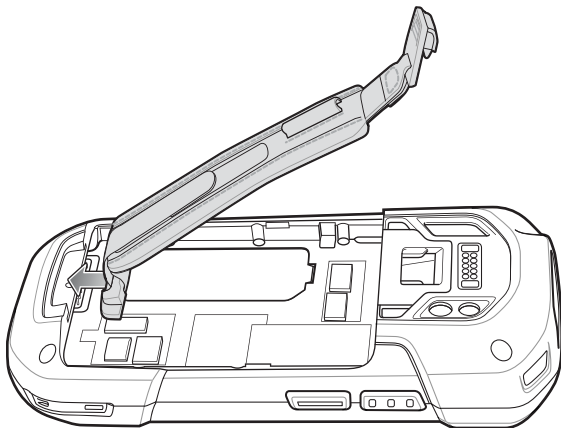

Figure 1-10 *Insert Hand Strap*

3. Insert the battery, bottom first, into the battery compartment in the back of the TC75.

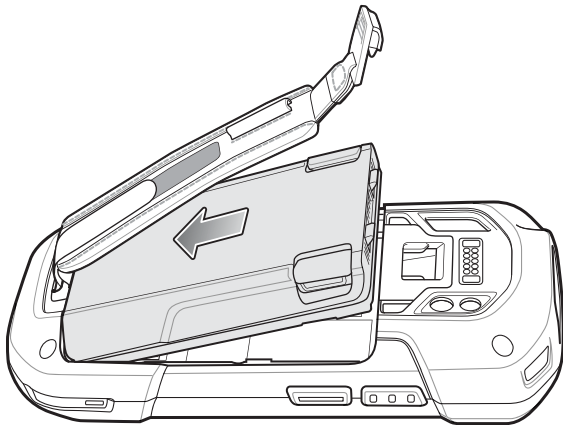

Figure 1-11 *Insert Bottom of Battery into Battery Compartment*

4. Rotate the top of the battery into the battery compartment.
5. Press the battery down into the battery compartment until the battery release latches snap into place.

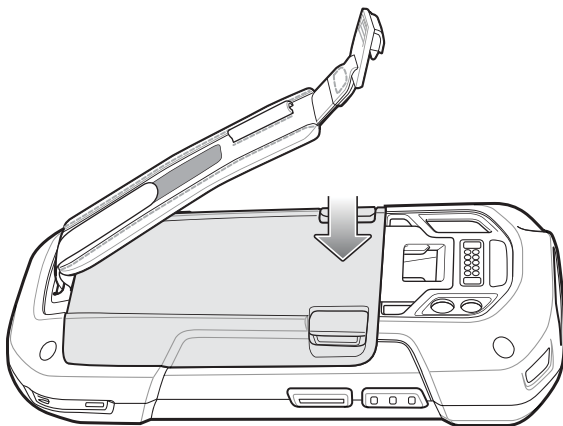

Figure 1-12 *Press Down on Battery*

6. Place hand strap clip into hand strap mounting slot and pull down until it snaps into place.

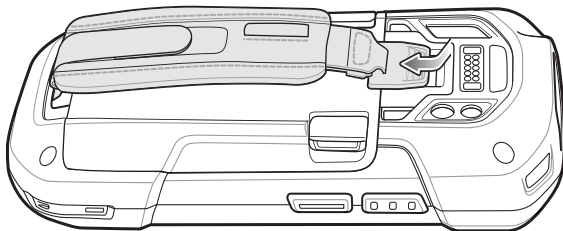

Figure 1-13 *Secure Hand Strap Clip*

Installing the Battery

1. Insert the battery, bottom first, into the battery compartment in the back of the TC75.

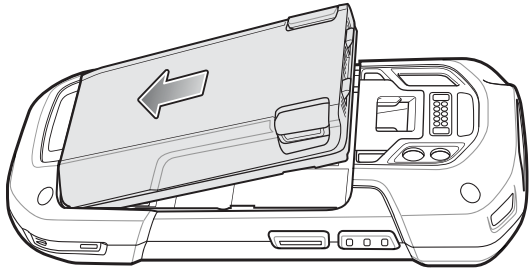

Figure 1-14 *Insert Bottom of Battery into Battery Compartment*

2. Rotate the top of the battery into the battery compartment.
3. Press the battery down into the battery compartment until the battery release latches snap into place.

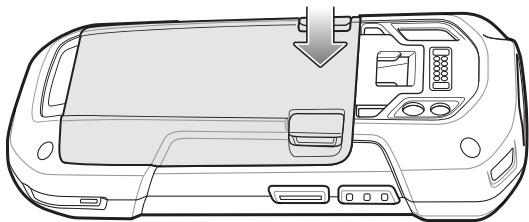

Figure 1-15 *Press Down on Battery*

Charging the Battery

Before using the TC75 for the first time, charge the main battery until the green Charging/Notification light emitting diode (LED) remains lit. To charge the TC75, use a cable or a cradle with the appropriate power supply. For information about the accessories available for the TC75, see [Chapter 7, Accessories](#) for more information.

- Snap-On USB Cable
- Charging Cable Cup
- 2-Slot Charge Only Cradle
- 2-Slot USB/Ethernet Cradle
- 5-Slot Charge Only Cradle
- 5-Slot Ethernet Cradle
- Charge Only Vehicle Cradle
- Auto Charging Cable Cup.
- Serial Cable Cup

The 4,620 mAh battery fully charges in approximately six hours at room temperature.

Charge batteries in temperatures from 0 °C to 40 °C (32 °F to 104 °F). The TC75 or accessory always performs battery charging in a safe and intelligent manner. At higher temperatures (e.g. approximately +37 °C (+98 °F)) the TC75 or accessory may for small periods of time alternately enable and disable battery charging to keep the battery at acceptable temperatures. The TC75 or accessory indicates when charging is disabled due to abnormal temperatures via its LED.

1. To charge the main battery, connect the charging accessory to the appropriate power source.
2. Insert the TC75 into a cradle or attach to a cable. The TC75 turns on and begins charging. The Charging/Notification LED blinks amber while charging, then turns solid green when fully charged.

Charging Indicators

Table 1-3 Charging/Notification LED Charging Indicators

State	Indication
Off	TC75 is not charging. TC75 is not inserted correctly in the cradle or connected to a power source. Charger/cradle is not powered.
Slow Blinking Amber (1 blink every 2 seconds)	TC75 is charging.
Solid Green	Charging complete.
Fast Blinking Amber (2 blinks/second)	Charging error, e.g.: <ul style="list-style-type: none"> • Temperature is too low or too high. • Charging has gone on too long without completion (typically eight hours).
Slow Blinking Red (1 blink every 2 seconds)	TC75 is charging but the battery is at end of useful life.
Solid Red	Charging complete but the battery is at end of useful life.
Fast Blinking Red (2 blinks/second)	Charging error but the battery is at end of useful life., e.g.: <ul style="list-style-type: none"> • Temperature is too low or too high. • Charging has gone on too long without completion (typically eight hours).

Google Account Setup



NOTE The TC75 has to be connected to the internet, either through WAN or Wi-Fi, in-order to set up a Google account.

The first time the TC75 starts, the Setup Wizard displays. Follow the on-screen instructions to set up a Google account, configure Google Wallet for purchasing items from the Play Store, entering your personal information, and enabling backup/restore features.

Replacing the Battery



CAUTION Do not add or remove SIM, SAM or microSD card during battery replacement.

1. Remove any accessory attached to the device.
2. Press the Power button until the menu appears.
3. Touch **Battery Swap**.
4. Follow the on-screen instructions.
5. Wait for the LED to turn off.

6. If hand strap is attached, slide the hand strap clip up toward the top of the TC75 and then lift.

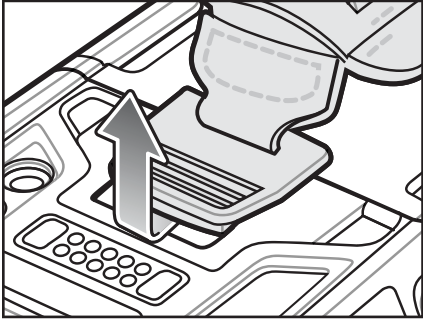

Figure 1-16 *Remove Hand Strap Clip*

7. Press the two battery latches in.

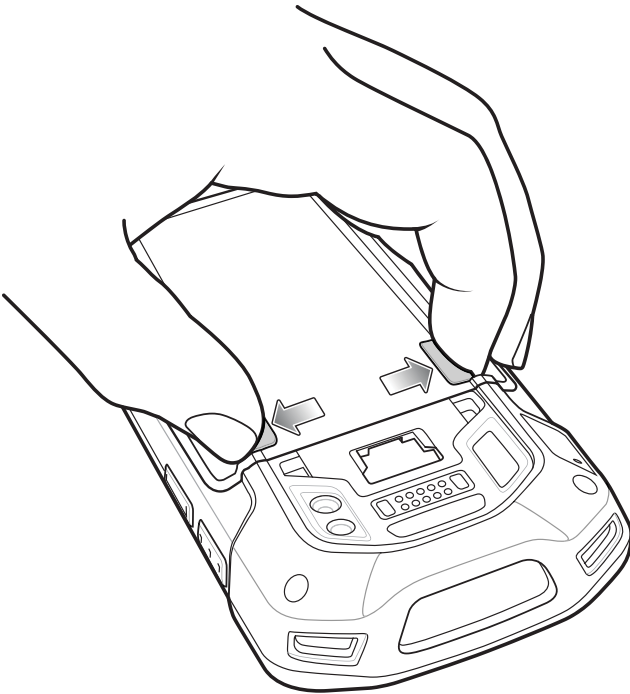

Figure 1-17 *Press Battery Latches*

8. Lift the battery from the TC75.

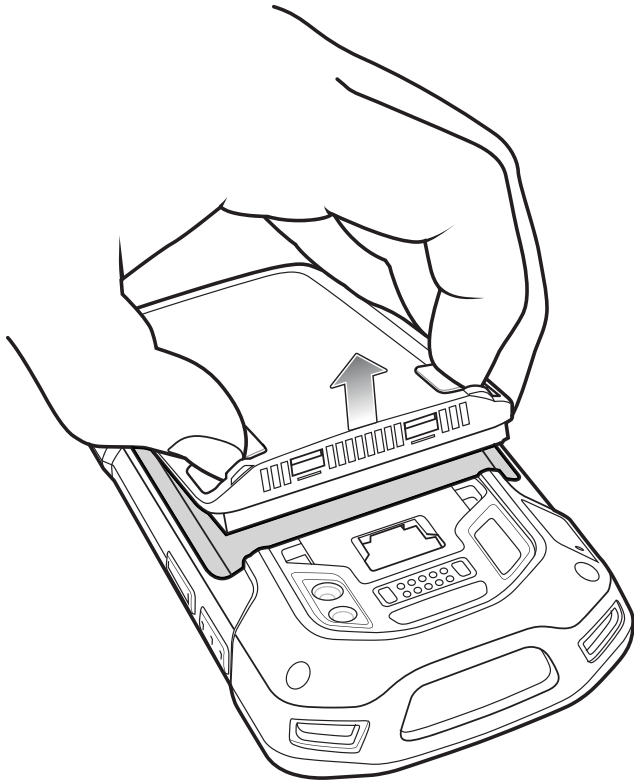

Figure 1-18 *Lift the Battery*



CAUTION Replace the battery within two minutes. After two minutes the device reboots and data may be lost.

9. Insert the replacement battery, bottom first, into the battery compartment in the back of the TC75.
10. Press the battery down until the battery release latch snaps into place.
11. Replace the hand strap, if required.
12. Press and hold the Power button to turn on the TC75.

Replacing the SIM or SAM Card

To replace the SIM or SAM card:

1. Press and hold the Power button until the menu appears.
2. Touch **Power off**.
3. Touch **OK**.
4. If hand strap is attached, slide the hand strap clip up toward the top of the TC75 and then lift.

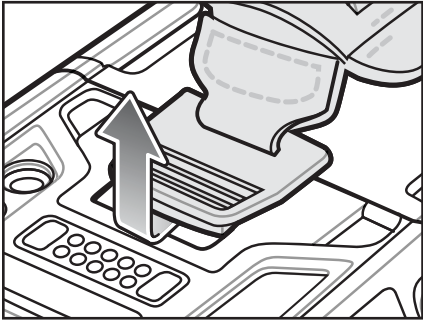

Figure 1-19 *Remove Hand Strap Clip*

5. Press the two battery latches in.
6. Lift the battery from the TC75.
7. Lift the access door.

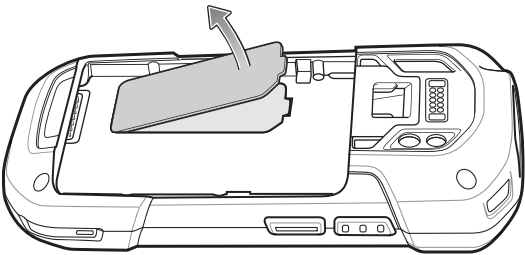

Figure 1-20 *Remove Access Door*

8. Remove card from holder.

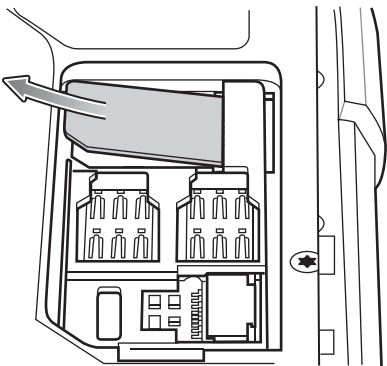

Figure 1-21 *Remove Mini SIM/SAM Card*

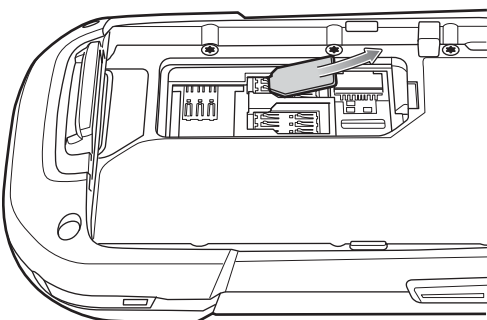

Figure 1-22 *Remove Nano SIM Card*

9. Insert the replacement card.

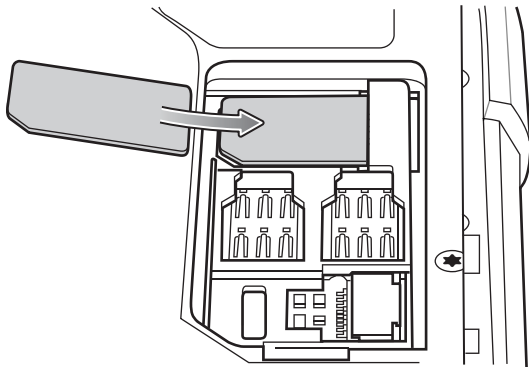

Figure 1-23 *Insert Mini SIM/SAM Card*

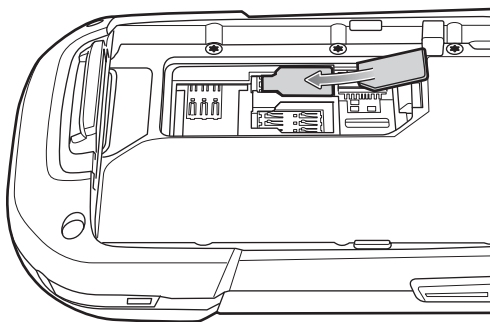

Figure 1-24 *Insert Nano SIM Card*

10. Replace the access door.

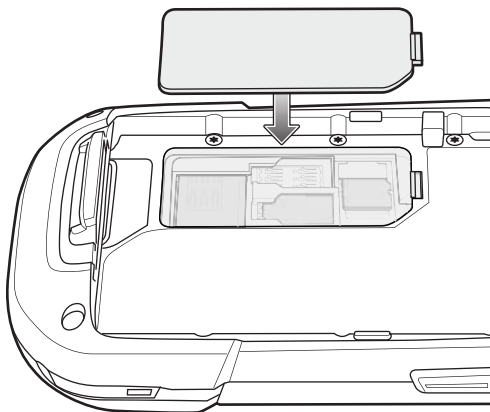

Figure 1-25 *Replace Access Door*

11. Press the access door down and ensure that it is properly seated.
12. Insert the battery, bottom first, into the battery compartment in the back of the TC75.
13. Press the battery down until the battery release latch snaps into place.
14. Replace the hand strap, if required.
15. Press and hold the Power button to turn on the TC75.

Replacing the microSD Card

To replace the microSD card:

1. Press the Power button until the menu appears.
2. Touch **Power off**.
3. Touch **OK**.
4. If hand strap is attached, slide the hand strap clip up toward the top of the TC75 and then lift.

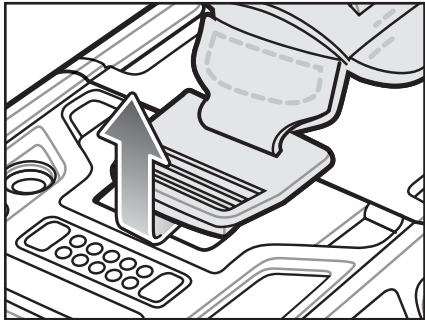

Figure 1-26 Remove Hand Strap Clip

5. Press the two battery latches in.
6. Lift the battery from the TC75.
7. Lift the access door.

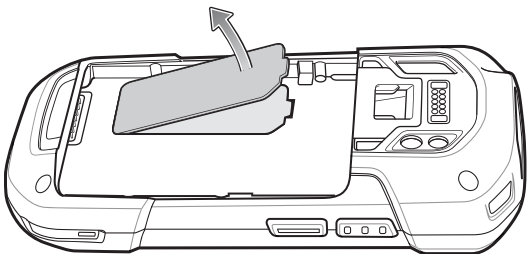

Figure 1-27 Remove Access Door

8. Remove microSD card from holder.
9. Press the access door down and ensure that it is properly seated.
10. Insert the replacement microSD card.
11. Replace the access door.

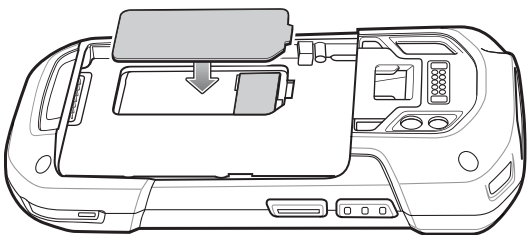





Figure 1-28 Replace Access Door

12. Insert the battery, bottom first, into the battery compartment in the back of the TC75.

13. Press the battery down until the battery release latch snaps into place.
14. Replace the hand strap, if required.
15. Press and hold the Power button to turn on the TC75.

Battery Management

✓ **NOTE** Prior to checking the battery charge level, remove the TC75 from any AC power source (cradle or cable).

To check the charge status of the main battery, on the Home screen touch  >  >  **About phone** > **Battery Information**.

Battery status indicates that the battery is discharging and **Battery level** lists the battery charge (as a percentage of fully charged).

Monitor Battery Usage

The **Battery** screen lists which applications consume the most battery power. Also use it to turn off applications that were downloaded if they are consuming too much power.

Touch  >  >  **Battery**.

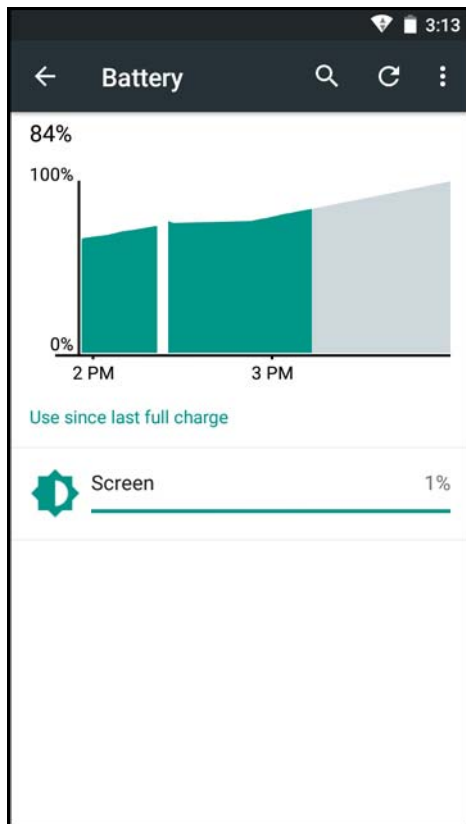

Figure 1-29 Battery Screen

The Battery screen lists the applications using the battery. The discharge graph at the top of the screen shows the rate of the battery discharge since last charged (short periods of time when connected to a charger are shown as thin green lines at the bottom of the chart), and how long it has been running on battery power.

Touch an application in the Battery screen to display details about its power consumption. Different applications display different information. Some applications include buttons that open screens with settings to adjust power use.

Low Battery Notification

When the battery charge level drops below 18%, the TC75 displays a notice to connect the TC75 to power. The user should charge the battery using one of the charging accessories.

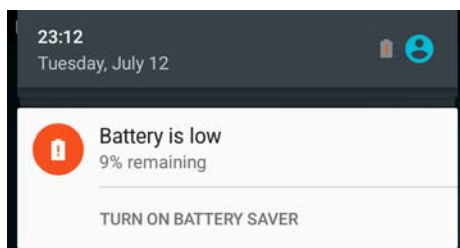

Figure 1-30 *Low Battery Notification*

When the battery charge drops below 10%, the TC75 displays a notice to turn on battery saver. The user must charge the battery using one of the charging accessories.

When the battery charge drops below 4%, the TC75 turns off.

The user must charge the TC75 using one of the charging accessories.

Battery Optimization

Observe the following battery saving tips:

- Disable DataWedge Launcher profile. Refer to the *TC75 Integrator Guide* for instructions.
- Remove Snap-on accessories when not in use.
- Set the screen to turn off after a short period of non-use. See [Setting Screen Timeout Setting on page 1-19](#).
- Reduce screen brightness. See [Setting the Screen Brightness on page 1-18](#).
- Turn off all wireless radios when not in use. Note that the global positioning system (GPS) receiver is only turned on when a GPS application is using the GPS radio.
- Turn off automatic syncing for Email, Calendar, Contacts and other applications.
- Minimize use of applications that keep the TC75 from suspending, for example, music, GPS and video applications.





Turning Off the Radios

To turn off all the radios:

1. Press the Power button until the menu appears.
2. Touch  **Airplane mode**. The airplane icon  appears in the Status bar indicating that all the radios are off.

Setting the Date and Time

The date and time is automatically synchronized using a NITZ server when the TC75 is connected to a cellular network. The user is only required to set the time zone or set the date and time when not connected to a cellular network or if the wireless LAN does not support Network Time Protocol (NTP).

1. On the Home screen, touch  >  >  **Date & time**.
2. Touch **Automatic date & time** to disable automatic date and time synchronization.
3. Touch **Set date**.
4. Scroll up and down to select the month, date and year.
5. Touch **OK**.
6. Touch **Set time**.
7. Select the hour, minutes and part of the day.
8. Touch **OK**.
9. Touch **Select time zone**.
10. Select the current time zone from the list.
11. Touch .

Display Setting

Use Display settings to change the screen brightness, change the background image, enable screen rotation, set sleep time and change font size.

Setting the Screen Brightness

To set the screen brightness:



1. Touch  >  >  **Display**.
2. **Adaptive brightness** sets the TC75 to automatically adjust the brightness using the built-in light sensor. Touch to disable adaptive brightness and set the brightness manually.
3. Touch **Brightness level**.



Figure 1-31 *Brightness Dialog Box*

4. Touch .

Setting Screen Rotation

By default, screen rotation is disabled. To enable screen rotation:

1. Touch  >  >  **Display**.
2. Touch **When device is rotated**.





- **Rotate the contents of the screen** - sets the TC75 to automatically switch orientation when the TC75 is rotated.
- **Stay in current orientation** - sets the TC75 to stay in the current orientation when the TC75 is rotated.

✓ **NOTE** The Home screen does not rotate.

3. Touch .





Setting Screen Timeout Setting

To set the screen sleep time:

1. Touch  >  >  **Display**.
2. Touch **Sleep**.
3. Select one of the sleep values.
 - **15 seconds**
 - **30 seconds**
 - **1 minute** (default)
 - **2 minutes**
 - **5 minutes**
 - **10 minutes**
 - **30 minutes**
4. Touch .

Setting Font Size

To set the size of the font in system applications:

1. Touch  >  >  **Display**.
2. Touch **Font size**.
3. Select one of the font size values.
 - **Small**
 - **Normal** (default)
 - **Large**
 - **Huge**
4. Touch .

Setting Touch Key Light

The four touch keys under the screen are backlit. Configure the touch key light to save battery power.

1. Touch  >  >  **Display**.

2. Touch **Touch key light**.
3. Select one of the options.
 - **Always off** - The touch key light is off.
 - **6 seconds** - The touch key light stays on for six seconds and then turns off (default).
 - **10 seconds** - The touch key light stays on for 10 seconds and then turns off.
 - **15 seconds** - The touch key light stays on for 15 seconds and then turns off.
 - **30 seconds** - The touch key light stays on for 30 seconds and then turns off.
 - **1 minute** - The touch key light stays on for one minute and then turns off.
 - **Always on** - The touch key light is on when the screen is on.

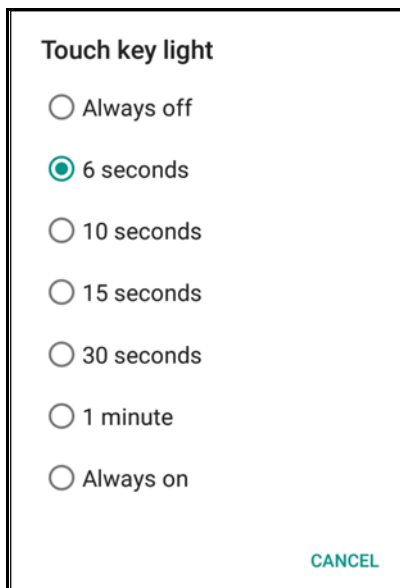

Figure 1-32 Touch Key Light Dialog Box

4. Touch .

Touch Mode

The TC75 display is able to detect touches using a finger, a conductive-tip stylus or gloved finger.

- ✓ **NOTE** A glove can be made of medical latex, leather, cotton or wool.
For optimal performance use Zebra certified stylus.

1. Touch  >  >  **Display**.
2. Touch **Touch Mode**.

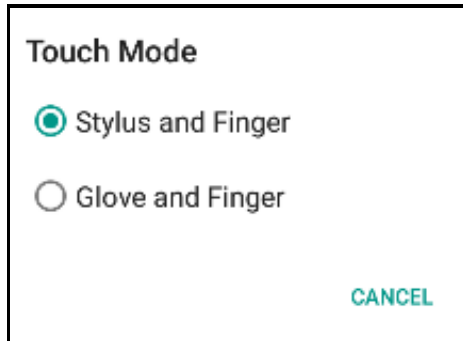





Figure 1-33 *Touch Mode Dialog Box*

3. Touch **Stylus and Finger** (default) to use a finger or a stylus on the screen or touch **Glove and Finger** to use a finger or a gloved finger on the screen.
4. Touch .

General Sound Setting

Use the Sounds settings to configure media and alarm volumes.

On the Home screen, touch  >  >  **Sound & notification**.

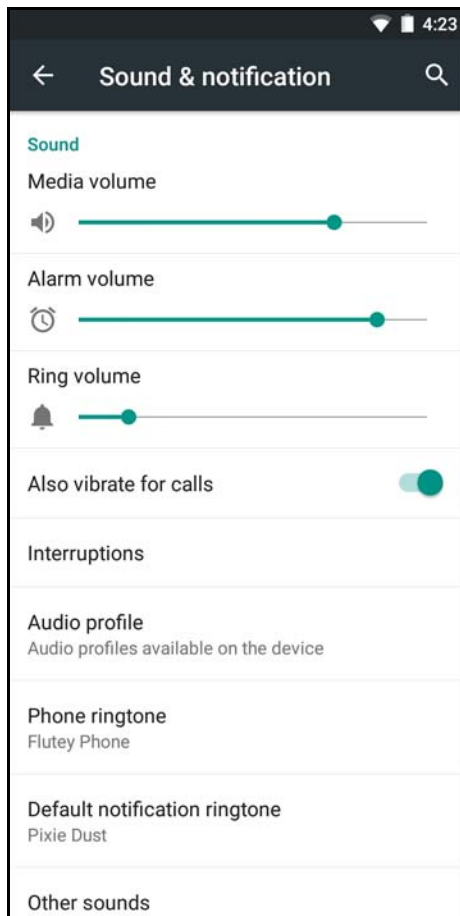





Figure 1-34 *Sound & Notification Screen*

Sound

Use the sound settings to change the volume of media, ringtones, notifications and alarms.

- **Media Volume**  - Controls the music and media volume.
- **Alarm Volume**  - Controls the alarm clock volume.
- **Ring Volume**  - Controls the ringtone volume.
- **Also vibrate for calls** - Touch to set the phone to ring even when the ring volume is up (default - enabled).

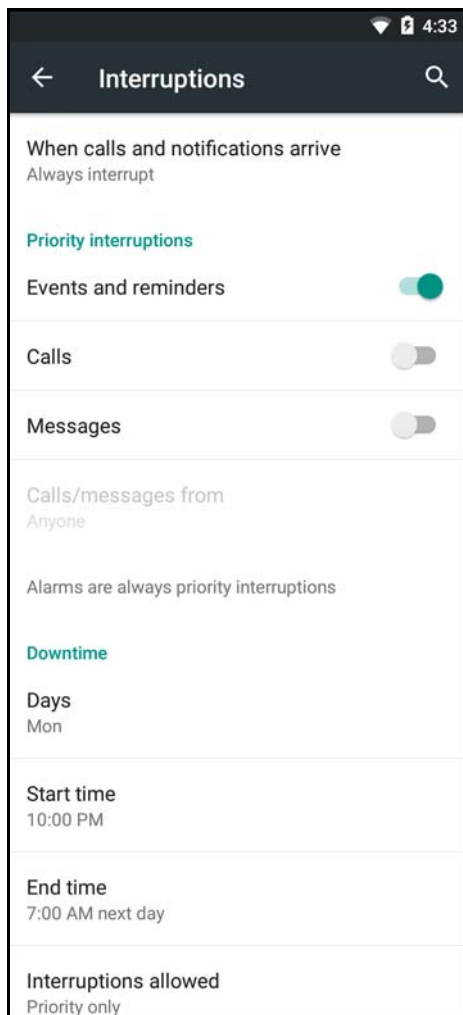

Figure 1-35 *Volumes Dialog Box*

- **Interruptions**
 - **When calls and notifications arrive** - Touch to select when calls and notifications arrive.
 - Priority Interruptions
 - **Events and reminders** - Touch to allow events and reminders notifications to come through.
 - **Calls** - Touch to silence all calls.
 - **Messages** - Touch to allow message notifications to come through.
 - **Calls/messages from** - Touch to choose which types of contacts can come through.
 - **Downtime**
 - **Days** - Touch to choose which days priority interruption settings are enabled.
 - **Start time** - Touch to choose a start time when priority interruption settings are enabled.
 - **End time** - Touch to choose an end time when priority interruption settings are disabled.
 - **Interruptions allowed** - Touch to choose if priority interruptions are allow or no interruptions are allowed.
- **Audio profile** – Touch to set audio profile. On the **Audio profile** screen, touch **Audio profile**.
 - **General** – Standard audio settings (default).

- **Increased clarity** – Increased volume on higher frequencies.

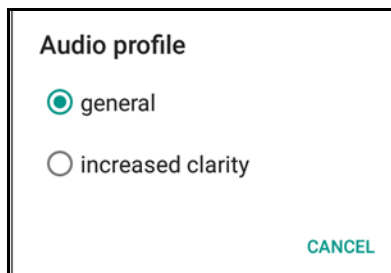





Figure 1-36 Audio Profile Dialog Box

- **Phone ringtone** - Touch to select a ringtone to sound when an incoming call is received.
- **Default notification ringtone**- Touch to select a sound to play for all system notifications.
- Other sounds
 - **Dial pad touch tones** - Check to play a sound when a phone key is touched (default – enabled).
 - **Touch sounds** - Check to play a sound when making screen selections (default – enabled).
 - **Screen lock sounds**- Check to play a sound when locking and unlocking the screen (default – disabled).
 - **Vibrate on touch** - Check to have the device vibrate when touching soft keys and on certain screen interactions (default – enabled).

Notification

Use the notification settings to configure how notifications arrive and which notifications arrive.

On the Home screen, touch  >  >  **Sound & notification**.

- **Pulse notification light**
The Charging/Notification LED lights blue when an application, such as email and VoIP, generates a programmable notification or to indicate when the TC75 is connected to a Bluetooth device. By default, LED notifications are enabled. To change the notification setting:
Touch **Pulse notification light** to toggle the notification on or off.
- **When device is locked** - Manage whether notifications can be seen when the TC75 is locked.
- **App notification** - Modify the notification settings individually for an application. The setting under **When device is locked** always takes precedence over the setting for an individual application.
- **Notification access** - Displays which applications can access notifications.
When a notification arrives, its icon appears at the top of the screen. Icons for pending notifications appear on the left, and system icons on the right.

Wake-Up Sources

By default the TC75 wakes from suspend mode when the user presses the power button. The TC75 can be configured to wake when the user presses the PTT or Scan buttons on the left side of the device.

1. Touch  >  >  **Wake-Up Sources**.
2. Touch **Keypad** checkbox. A blue check appears in the checkbox.

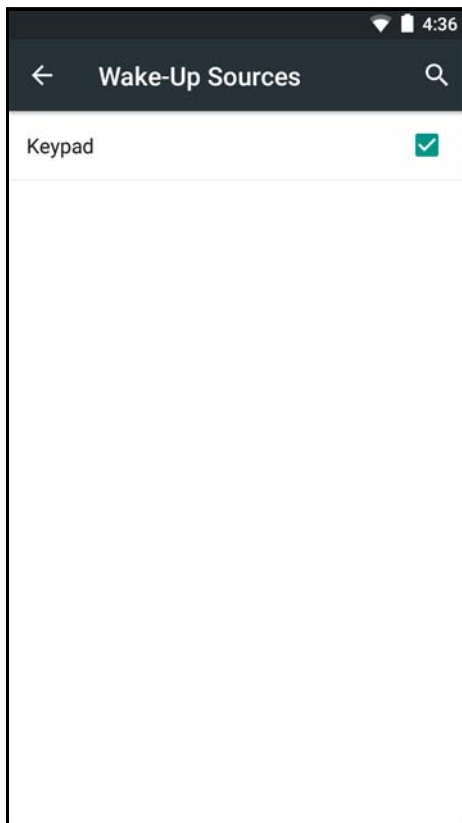



Figure 1-37 *Wake-Up Sources Dialog Box*

3. Touch .

CHAPTER 2 USING THE TC75

Introduction

This chapter explains the buttons, status icons, and controls on the TC75, and provides basic instructions for using the TC75, including resetting the TC75 and entering data.



Google Mobile Services



NOTE This section only applies to TC75 configurations with Google Mobile Services (GMS).

The TC75 with GMS contains applications and services that provide additional functionality to the TC75.

GMS includes:

- **Applications** - GMS adds a variety of Google applications and associated widgets including Chrome, Gmail, Drive and Maps.
- **Services:**
 - **Speech to Text** - Allows for free format speech to text, in many languages for both connected and disconnected network. Launch by touching the microphone icon on the keyboard.
 - **TalkBack Service** - Provides spoken feedback on various parts of the user interface. To enable, go to **Settings > Accessibility**.
 - **Network Location Provider** - Adds a location provider which uses mobile network tower information and Wi-Fi access point information to provide a location without using GPS. To enable, go to  **Settings >  Location access**.
 - **Widevine DRM** - Enables the digital rights management so that protected content can be played. Enable via DRM Info from the Play Store.
 - **Google Cloud Messaging** - Allows the sending of data from your server to your TC75 and also to receive messages from devices on the same connection.
 - **Backup and Restore** - Allows the users settings and applications to be backed up to a Google server and subsequently restored from that server after a factory reset.

- **Google accounts** - Create and use a Google account to synchronize mail, files, music, photos, contacts and calendar events.

Home Screen

The Home screen displays when the TC75 turns on. Depending upon the configuration, the Home screen might appear different. Contact your system administrator for more information.

After a suspend or screen time-out, the Home screen displays with the lock sliders. Slide  up to unlock the screen. For screen locking information see [Un-Locking the Screen on page 2-17](#).



Figure 2-1 Home Screen

Table 2-1 Home Screen Items

Item	Description
1 — Status Bar	Displays the time, status icons (right side), and notification icons (left side). For more information see Status Bar on page 2-3 and Managing Notifications on page 2-6 .
2 — Browser Icons	Opens browser application.
3 — All Apps Icon	Opens the APPS window.

Table 2-1 Home Screen Items (Continued)

Item	Description
4 — Shortcut Icons	Opens applications installed on the TC75. See Application Shortcuts and Widgets on page 2-8 for more information.
5 — Widgets	Launches stand-alone applications that run on the Home screen. See Application Shortcuts and Widgets on page 2-8 for more information.

The Home screen provides four additional screens for placement of widgets and shortcuts. Swipe the screen left or right to view the additional screens.

Status Bar

The Status bar displays the time, notification icons (left side) and status icons (right side).

**Figure 2-2** Notification and Status Icons

If there are more notifications than can fit in the Status bar,  displays indicating that more notifications exist. Open the Notifications panel to view all notifications and status.

Status Icons

Table 2-2 Status Icons







Icon	Description
	Indicates that the Alarm is active.
	Indicates that all sounds except media and alarms are silenced and vibrate mode is active.
	Indicates that all sounds except media and alarms are silenced.
	Indicates that the battery is fully charged.
	Indicates that the battery is partially drained.
	Indicates that the battery charge is low.
	Indicates that the battery charge is very low.

Table 2-2 Status Icons (Continued)











Icon	Description
	Indicates that the battery is charging.
	Indicates that the Airplane Mode is active. All radios are turned off.
	Indicates that Bluetooth is on.
	Connected to a Wi-Fi network.
	No Wi-Fi signal.
	Mobile network signal strength.
	No mobile network signal.
4G LTE	Connected to an 4G LTE network.
4G	Connected to an 4G network.
3G	Connected to a 3G network.
H	Connected to an HSPA network.
E	Connected to an EDGE network.
G	Connected to an GPRS network.
R	Roaming from a network.
	No SIM card installed.

Table 2-2 *Status Icons (Continued)*

Icon	Description
	Connected to an Ethernet network.
	Headset audio cable is connected to the TC75.

Notification Icons

Table 2-3 *Notification Icons*

















Icon	Description
	Indicates that more notifications are available for viewing.
	Indicates that data is syncing.
	Indicates an upcoming event.
	Indicates that an open Wi-Fi network is available.
	Indicates that a song is playing.
	Indicates that a problem with sign-in or sync has occurred.
	Indicates that the TC75 is uploading data.
	Indicates that the TC75 is downloading data when animated and download is complete when static.
	Indicates that the TC75 is connected via USB cable.
	Indicates that the TC75 is connected to or disconnected from virtual private network (VPN).
	Preparing SD card.

Table 2-3 *Notification Icons (Continued)*

Icon	Description
	Indicates that USB debugging is enabled on the TC75.
	Indicates that the MultiUser feature is enabled. Appears only when MultiUser Administrator application is installed.
	Indicates that a new user is logging in. Appears only when MultiUser Administrator application is installed.
	Indicates the status of the PTT Express Voice Client. See Notification Icons for complete list of PTT Express notification icons.
	Indicates that DataWedge application is running on the device.

Managing Notifications

Notification icons report the arrival of new messages, calendar events, and alarms, as well as ongoing events. When a notification occurs, an icon appears in the Status bar with a brief description. See [Notification Icons on page 2-5](#) for a list of possible notification icons and their description. Open the Notifications panel to view a list of all the notifications.

To open the Notification panel drag the Status bar down from the top of the screen.

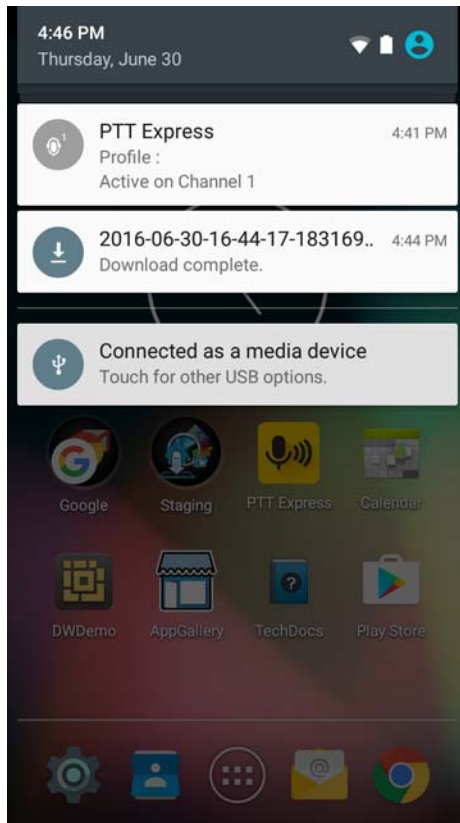



Figure 2-3 *Notification Panel*

To respond to a notification, open the Notifications Panel and then touch a notification. The Notifications Panel closes and the subsequent activity is dependent on the notification.

To clear all notifications, open the Notifications Panel and then touch . All event-based notifications are removed. Ongoing notifications remain in the list.

To close the Notification Panel, swipe the Notifications Panel up or touch .

Quick Settings

Use Quick Settings to get to frequently used settings, like turning on airplane mode. To open Quick Settings, swipe down from the top of the screen with two fingers or twice with one finger.

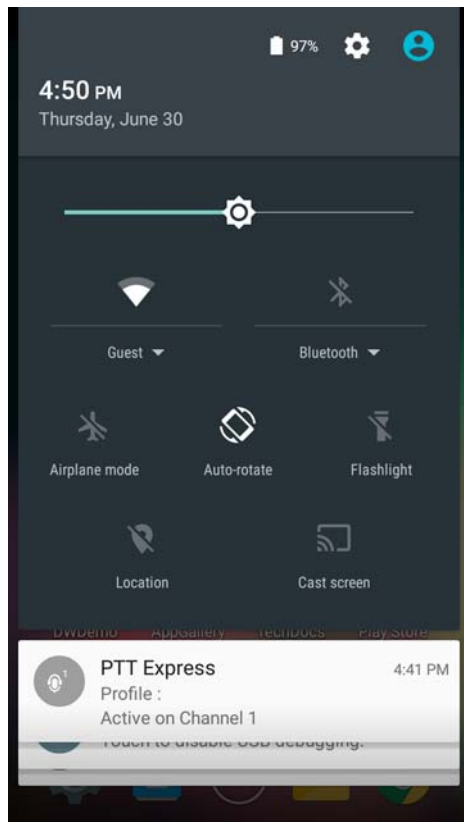





Figure 2-4 Quick Settings

To change a setting, just touch the icon:

- Display brightness: Slide to lower or increase the brightness of the screen.
- Wi-Fi network: Turn Wi-Fi on or off. To open Wi-Fi settings, touch the Wi-Fi network name.
- Bluetooth settings: Turn Bluetooth on or off. To open Bluetooth settings, touch the Bluetooth.
- Airplane mode: Turn airplane mode on or off. Airplane mode means device will not connect to Wi-Fi or Bluetooth.
- Auto-rotate: Lock the device's orientation in portrait or landscape mode or set to automatically rotate.
- Flashlight: Turn the camera LED flash on or off.
- Location: Turn location services on or off. To open location settings, touch  >  **Location**.
- Cast screen: Share phone content on Chromecast or a television with Google Cast built-in. Touch cast screen to display a list of devices, then touch a device to begin casting.

To close the Quick Settings Panel, swipe the Quick Settings Panel up or touch .

Application Shortcuts and Widgets

Application shortcuts placed on the Home screen allow quick and easy access to applications. Widgets are self-contained applications placed on the Home screen to access frequently used features.

Adding an Application or Widget to the Home Screen

1. Go to the desired Home screen.

2. Touch .
3. Swipe right, if necessary, to find the application icon or widget.
4. Touch and hold the icon or widget until the Home screen appears.
5. Position the icon on the screen and then release.

Moving Items on the Home Screen

1. Touch and hold the item until it floats on the screen.
2. Drag the item to a new location. Pause at the edge of the screen to drag the item onto an adjacent Home screen.
3. Lift finger to place the item on the Home screen.

Removing an App or Widget from the Home Screen

1. Go to the desired Home screen.
2. Touch and hold the application shortcut or widget icon until it floats on the screen.
3. Drag the icon to  Remove on the top of the screen and then release.

Folders

Use **Folders** to organize similar applications together. Tap the folder to open and display items in the folder.

Creating a Folder

To create a folder, there must be at least two app icons on the Home screen.

1. Go to the desired Home screen.
2. Touch and hold on one application icon.
3. Drag the icon and stack on top of another icon.
4. Release the icon. A folder is created containing both icons.

Naming Folders

1. Touch the folder.

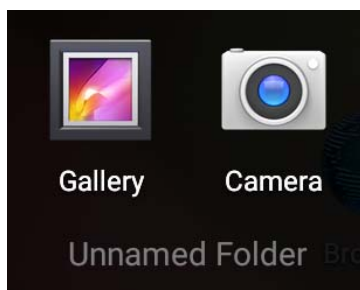

Figure 2-5 *Open Folder*

2. Touch the title area and enter a folder name using the keyboard.
3. Touch **Done** on the keyboard.
4. Touch anywhere on the Home screen to close the folder. The folder name appears under the folder.



Photos

Figure 2-6 *Renamed Folder*

Removing a Folder

1. Touch and hold the folder icon until it enlarges.
2. Drag the icon to Remove and release.

Home Screen Wallpaper

✓ **NOTE** Use of Live Wallpaper may reduce battery life.

Changing the Home Screen Wallpaper

1. Touch .
2. Touch **Wallpaper**.
3. From the **Choose wallpaper from** menu, touch **Gallery**, **Live wallpapers** or **Wallpapers**.
 - **Gallery** - Select to use an image stored on the device.
 - **Live wallpapers** - Select to use an animated wallpaper image.
 - **Wallpapers** - Select to use a wallpaper image.
4. Touch **Set wallpaper**.

Using the Touchscreen

Use the multi-tap sensitive screen to operate the device.

- **Tap** - Tap to:
 - select items on the screen
 - type letters and symbols using the on-screen keyboard
 - press on-screen buttons.
- **Tap and Hold** - Tap and hold:
 - an item on the Home screen to move it to a new location or to the trash.
 - an item in Apps to create a shortcut on the Home screen.
 - the Home screen to open a menu for customizing the Home screen.
 - an empty area on the Home screen until the menu appears.
- **Drag** - Tap and hold an item for a moment and then move finger on the screen until reaching the new position.

- **Swipe**- Move finger up and down or left and right on the screen to:
 - unlock the screen
 - view additional Home screens
 - view additional application icons in the Launcher window
 - view more information on an application's screen.
- **Double-tap** - Tap twice on a web page, map, or other screen to zoom in and out.
- **Pinch** - In some applications, zoom in and out by placing two fingers on the screen and pinching them together (to zoom out) or spreading them apart (to zoom in).

Using the On-screen Keyboard

Use the on-screen keyboard to enter text in a text field. To configure the keyboard settings, touch and hold , (comma) or / (forward slash) >  and then select **Android keyboard settings**.

Editing Text

Edit entered text and use menu commands to cut, copy, and paste text within or across applications. Some applications do not support editing some or all of the text they display; others may offer their own way to select text.

Entering Numbers, Symbols and Special Characters

To enter numbers and symbols:

- Touch and hold one of the top-row keys until a menu appears then select a number. Keys with alternate characters display an ellipsis (...) below the character.
- Touch and hold the Shift key with one finger, touch one or more capital letters or symbols to enter them, and then lift both fingers to return to the lowercase keyboard.
- Touch **?123** to switch to the numbers and symbols keyboard.
- Touch the **=\<** key on the numbers and symbols keyboard to view additional symbols.

To enter special characters, touch and hold a number or symbol key to open a menu of additional symbols.

- A larger version of the key displays briefly over the keyboard.
- Keys with alternate characters display an ellipsis (...) below the character.

Applications

The **APPS** screen displays icons for all installed applications. The table below lists the applications installed on the TC75. Refer to the *TC75 Integrator Guide* for information on installing and uninstalling application.

Table 2-4 Applications















Icon	Description
	AppGallery - Provides links to utilities and demonstration applications that can be installed on the TC75.
	Battery Manager - Displays battery information, including charge level, status, health and wear level.
	Battery Swap – Use to place device in Battery Swap mode when replacing the battery.
	Bluetooth Pairing Utility – Use to pair the RS507 Hans-free Imager with the TC75 by scanning a bar code.
	Browser - Use to access the Internet or intranet. TC75 Professional (without GMS) only.
	Calculator - Provides the basic and scientific arithmetic functions.
	Calendar - Use to manage events and appointments.
	Camera - Take photos or record videos. For more information see Camera on page 4-8 .
	Chrome - Use to access the Internet or intranet. TC75 Standard (with GMS) only.
	Clock - Use to schedule alarms for appointments or as a wake-up.
	Contacts - Use to manage contact information.
	DataWedge - Enables data capture using the imager.
	Downloads - lists all downloads files.
	Drive - Upload photos, videos, documents, and other files to personal storage site. TC75 Professional (with GMS) only.
	DWDemo - Provides a way to demonstrate the data capture features using the imager. See DataWedge Demonstration on page 4-23 for more information.

Table 2-4 Applications (Continued)















Icon	Description
	elemex — Use to provide diagnostic information. See Elemex on page 4-41 for more information.
	Email - Use to send and receive email.
	File Browser - Organize and manage files on the TC75. See File Browser on page 4-3 for more information.
	Gallery - Use to view photos stored on the microSD card. For more information, see Gallery on page 4-17 for more information.
	Gmail - Use to send and receive email using a Google email account. TC75 Standard (with GMS) only.
	Google - Launches Google search application. TC75 Standard (with GMS) only.
	Google Settings - Use to connect applications to Google account, setup Google Plus account, set location settings, set search features and configure Android Device Manager. TC75 Standard (with GMS) only.
	Hangouts - Use to communicate with friends using text messages and photos. TC75 Standard (with GMS) only.
	IST - Use to configure sensor related features and view available sensors on the device, sensor information, and versions of each component in sensor subsystem.
	Maps - Use to see you location on a map (with public transit, traffic or satellite overlays). Search for any business or place of interest. Provides turn-by-turn navigation with voice guidance and traffic-avoidance and alternate routes, for drivers, cyclist, walkers and users of public transportation. TC75 Standard (with GMS) only.
	Messaging - Send SMS and MMS messages. See Messaging on page 4-5 for more information.
	MLog Manager - Use to capture log files for diagnostics. See MLog Manager on page 4-30 for more information.
	MobiControl Stage – Opens the MobiControl Stage application to stage the device.
	MSP Agent - Enables management of the TC75 from an MSP server. Requires the purchase of an appropriate MSP client license per device to suit the level of management functionality required.

Table 2-4 Applications (Continued)























Icon	Description
	MSRN - Use verify authenticity of the paired Snap-on MSR and to provision the Snap-on MSR. See the <i>TC75 Integrator Guide</i> for more information.
	Music - Play music stored on the microSD card. TC75 Professional (without GMS) only.
	Phone - Use to dial a phone number when used with some Voice over IP (VoIP) clients (VoIP telephony ready only).
	Photos - Use to sync photos with Google account. TC75 Standard (with GMS) only.
	Play Movies & TV - View movies and video on your device. TC75 Standard (with GMS) only.
	Play Music - Use to listen to music. TC75 Standard (with GMS) only.
	Play Store - Download music, movies, books, and Android apps and games from the Google Play Store. TC75 Standard (with GMS) only.
	PTT Express - Use to launch PTT Express client for VoIP communication.
	Rapid Deployment - Allows the TC75 to stage a device for initial use by initiating the deployment of settings, firmware and software. Requires the purchase of an MSP client license per device.
	RxLogger - Use to diagnose device and application issues. See the <i>TC75 Integrator Guide</i> for more information.
	Search - Use the Google search engine to search the Internet and the TC75. TC75 Professional (without GMS) only.
	Settings - Use to configure the TC75.
	SimulScan Demo - Use to demonstrate the document capture feature of the TC75.
	Sound Recorder - Use to record audio. TC75 Professional (without GMS) only.
	StageNow - Allows the TC75 to stage a device for initial use by initiating the deployment of settings, firmware and software.

Table 2-4 Applications (Continued)

Icon	Description
	TechDocs - Opens the on-device User Guide for the TC75.
	Voice Dialer - Use to place calls by speaking.
	Voice Search - Use to perform searches by asking questions. TC75 Standard (with GMS) only.
	YouTube - Use to view videos on the YouTube web site. TC75 Standard (with GMS) only.
	AppLock Administrator - Use to configure the Application Lock feature. This icon appears after the optional application is installed.
	MultiUser Administrator - Use to configure the MultiUser feature. This icon appears after the optional application is installed.
	Secure Storage Administrator - Use to configure the Secure Storage feature. This icon appears after the optional application is installed.

Accessing Applications

All applications installed on the device are accessed using the **APPS** window.

1. On the Home screen, touch .

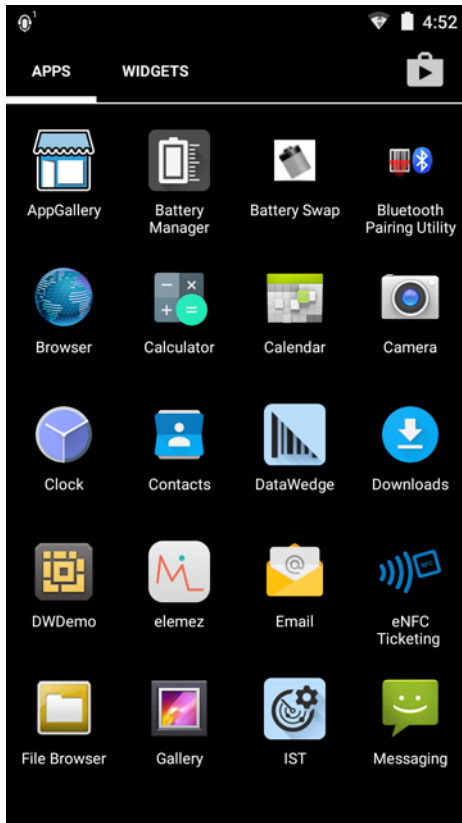

Figure 2-7 APPS Window Example

2. Slide the **APPS** window left or right to view more application icons. Touch an icon to open the application.



NOTE See [Application Shortcuts and Widgets on page 2-8](#) for information on creating a shortcut on the Home screen.

Switching Between Recent Applications

1. Touch and hold  (non-GMS devices) or  (GMS devices). A window appears on the screen with icons of recently used applications.

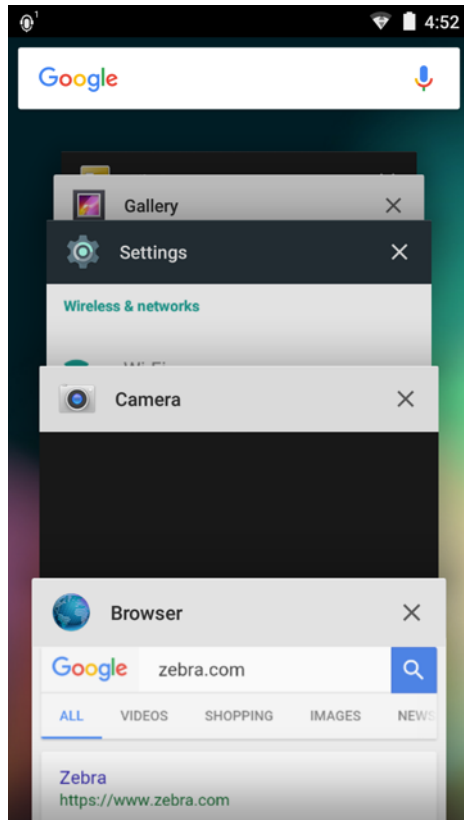



Figure 2-8 *Recently Used Applications*

2. Slide the window up and down to view all recently used applications.
3. Swipe left or right to remove application from the list and force close the application.
4. Touch an icon to open it or touch  to return to the current screen.

Un-Locking the Screen

Use the Lock screen to protect access to data on the TC75. Some email account require locking the screen. Refer to the *TC75 Integrator Guide* for information on setting up the locking feature. The Locking feature functions differently in Single User mode or Multiple User mode.

Single User Mode

When locked, a pattern, PIN or password is required to unlock the device. Press the Power button to lock the screen. The device also locks after a pre-defined time-out.

Press and release the Power button to wake the device.

The Lock screen displays. Slide  up to unlock the screen.

If the Pattern screen unlock feature is enabled, the Pattern screen appears instead of the Lock screen.

If the PIN or Password screen unlock feature is enabled, enter the PIN or password after unlocking the screen.

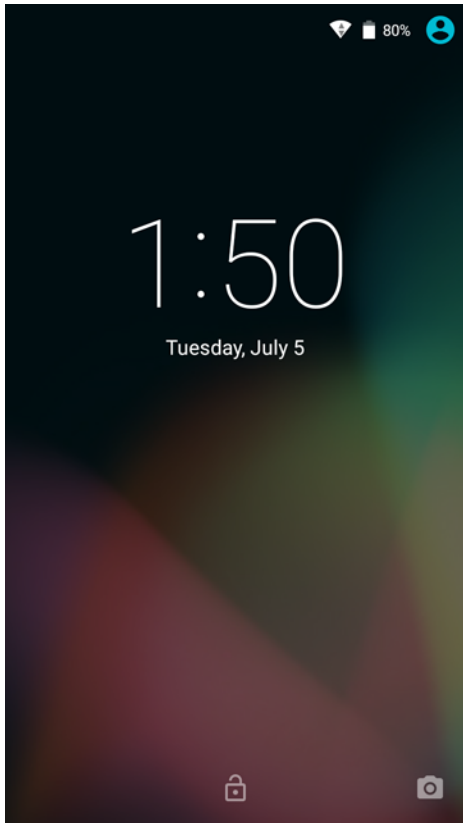

Figure 2-9 *Lock Screen*

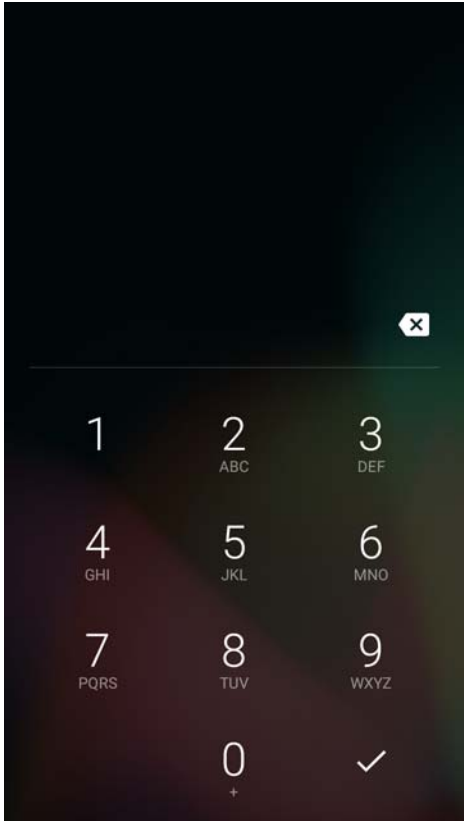

Figure 2-10 PIN Screen

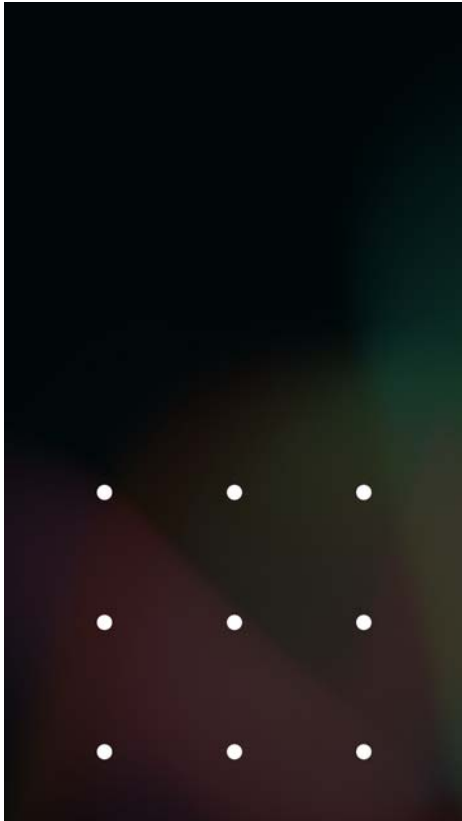

Figure 2-11 *Pattern Screen*

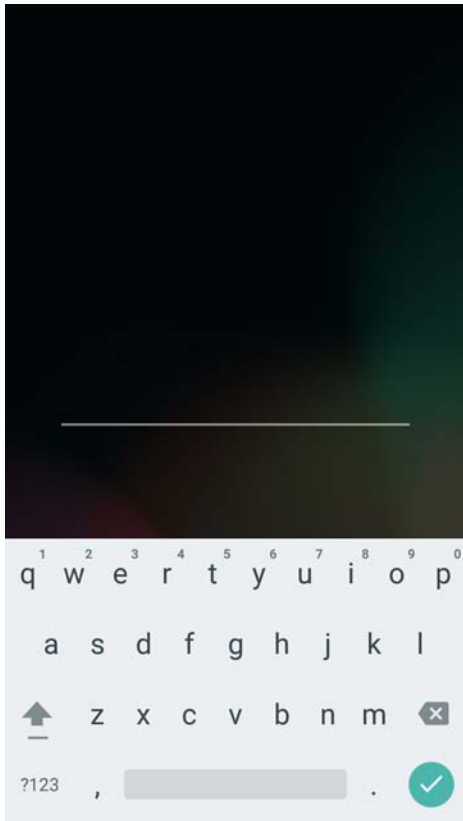

Figure 2-12 *Password Screen*

MultiUser Mode

With MultiUser login, multiple users can log on to the device with each user having access to various applications and features. When enabled, the Login screen appears after powering on, resetting or after the device wakes from suspend mode.

MultiUser Login

1. In the **Login** text field, enter the username.

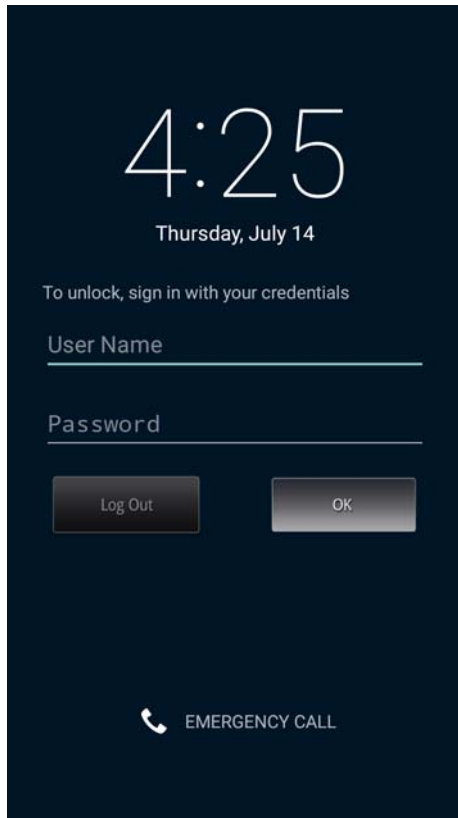

Figure 2-13 *Multiple User Log In Screen*

2. In the **Password** text field, enter the password.
3. Touch **OK**. After a resume from suspend, the user must enter the password.

MultiUser Logout

1. Drag the Status Bar down from the top of the screen.
2. Touch **MultiUser is active**.
3. Touch **Logout**.
4. The **Login** screen appears.

Resetting the Device

There are two reset functions, soft reset and hard reset.

Performing a Soft Reset

Perform a soft reset if applications stop responding.

1. Press and hold the Power button until the menu appears.
2. Touch **Reset**.
3. The device reboots.

Performing a Hard Reset



CAUTION Performing a hard reset with a SD card installed in the TC75 may cause damage or data corruption to the SD card.

Perform a hard reset if the TC75 stops responding.

1. Simultaneously press the Power, Scan and Volume Up buttons for at least four seconds.

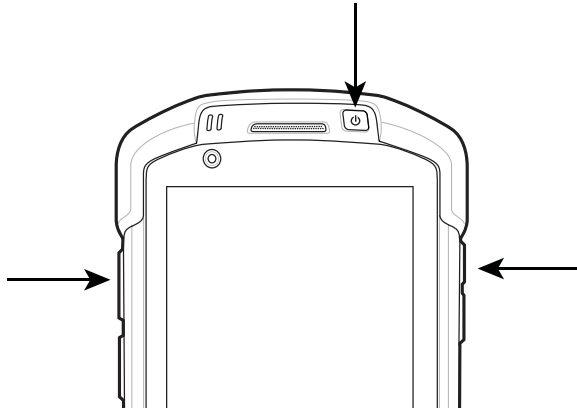



Figure 2-14 Three Button Reset

2. When the screen turns off, release the buttons.
3. The TC75 reboots.

Suspend Mode

The TC75 goes into suspend mode when the user presses the Power button or after a period of inactivity (set in the Display settings window).

To wake the TC75 from Suspend mode, press the Power button.

The Lock screen displays. Slide  up to unlock the screen. If the Pattern screen unlock feature is enabled, the Pattern screen appears instead of the Lock screen. See [Un-Locking the Screen on page 2-17](#).



NOTE If the user enters the PIN, password or pattern incorrectly five times, they must wait 30 seconds before trying again.

If the user forgets the PIN, password or pattern contact the system administrator.

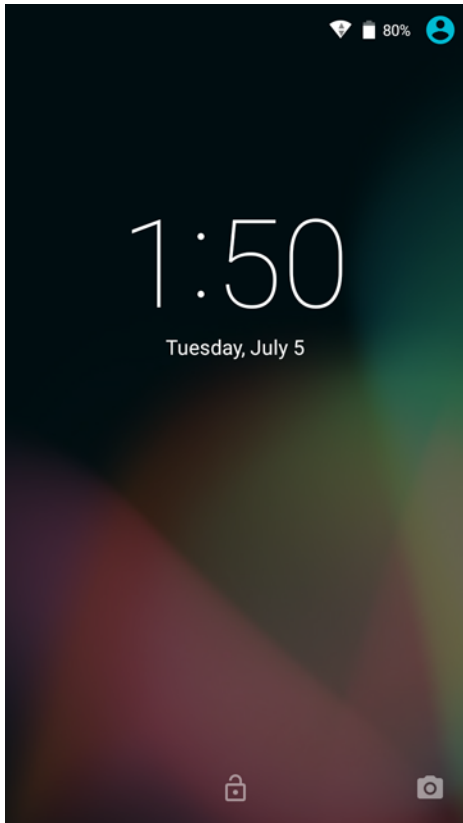

Figure 2-15 *Lock Screen*

CHAPTER 3 CALLS

Introduction

This chapter discusses making a phone call from the **Phone** application, the **Contacts** application or other applications or widgets that display contact information.

Emergency Calling

The service provider programs one or more emergency phone numbers, such as 911 or 999, that the user can call under any circumstances, even when the phone is locked, a SIM card is not inserted or the phone is not activated. The service provider can program additional emergency numbers into the SIM card. However, the SIM card must be inserted in the device in order to use the numbers stored on it. See the service provider for additional information.

- ✓ **NOTE** Emergency numbers vary by country. The phone's pre-programmed emergency number(s) may not work in all locations, and sometimes an emergency call cannot be placed due to network, environmental, or interference issues.

Audio Modes

The device offers three audio modes for use during phone calls:

- **Handset Mode:** Switches audio to the receiver at the top front of the device, so the user can use the device as a handset. This is the default mode.
- **Speaker Mode:** Use the device as if on speaker phone.
- **Headset Mode:** Connect a Bluetooth or wired headset to automatically switch audio to the headset.

Using a Bluetooth Headset

Use a Bluetooth headset for audio communication when using an audio-enabled application. See [Bluetooth on page 6-16](#) for information on connecting a Bluetooth headset to the device. Set the volume appropriately before putting on the headset. When a Bluetooth headset is connected, the speakerphone is muted.

Using a Wired Headset

Use a wired headset and Audio Adapter for audio communication when using an audio-enabled application. Set the volume appropriately before putting on the headset. When a wired headset is connected, the speakerphone is muted.

Lift the headset cover and insert the headset plug.

To end a call using the wired headset, press and hold the headset button until the call ends.

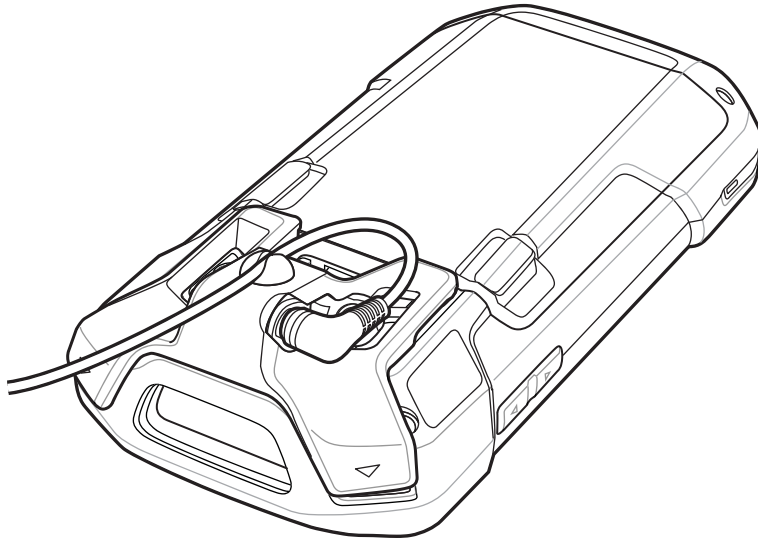

Figure 3-1 Insert Wired Headset Plug (2.5 mm Adapter Shown)

Adjusting Audio Volume



Use the Volume buttons to adjust the volume of the ringer when not in a call and the audio volume when in a call.





NOTE Adjust the conversation phone volume during a call. Adjusting the volume while not in a call affects the ring and notification sound levels.

Making a Call Using the Dialer

Use the dialer tab to dial phone numbers.

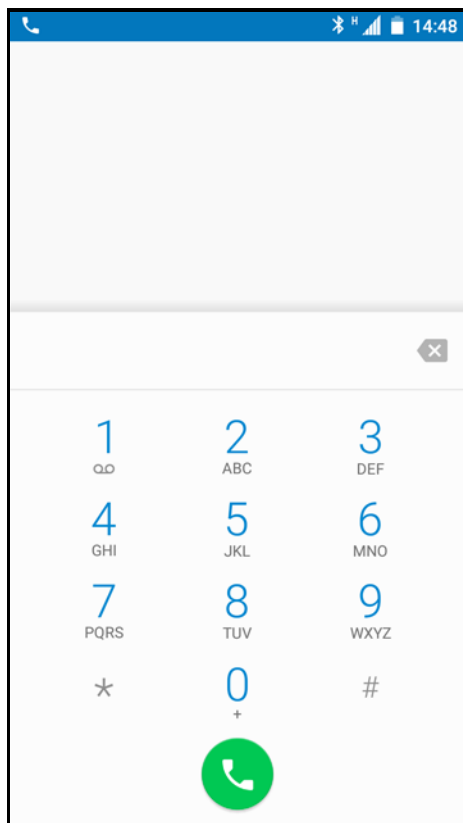
1. On the Home screen touch .
2. Touch .



3. Touch the keys to enter the phone number.
4. Touch  below the dialer to initiate the call.

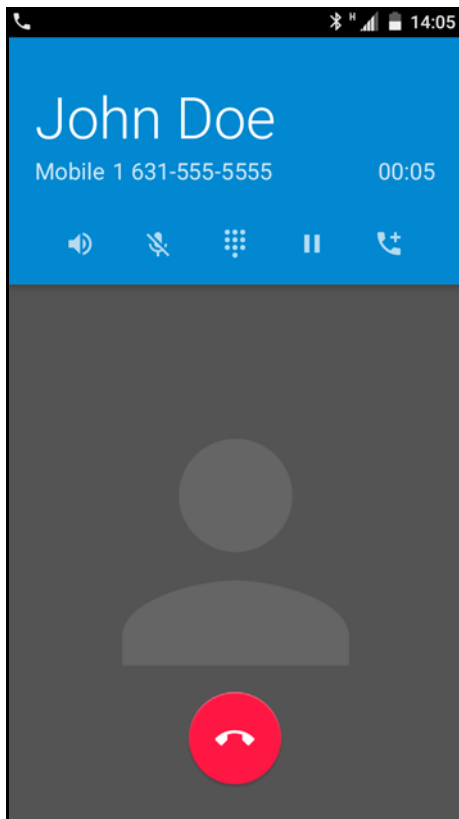







Figure 3-2 *Call in Progress*

-  - touch to send audio to the speakerphone.
-  - touch to mute the call.
-  - touch to display the dial pad.
-  - touch to place the call on hold.
-  - touch to create a conference call.

5. Touch  to end the call.

If using a Bluetooth headset, additional audio options are available. Touch the audio icon to open the audio menu.

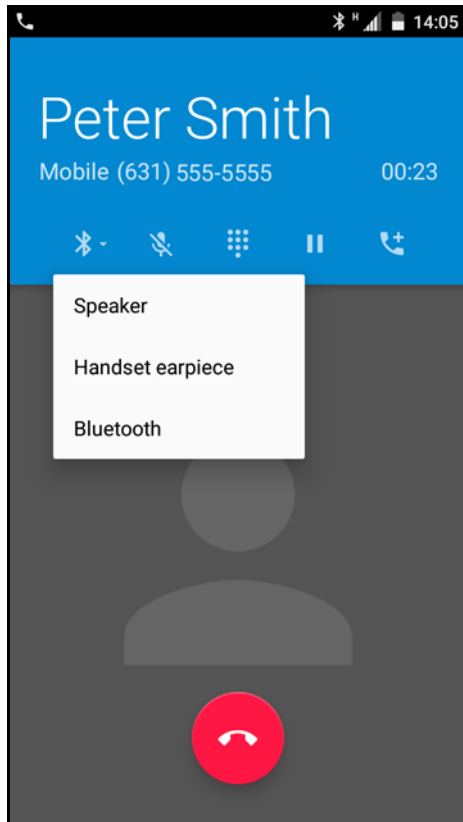





Figure 3-3 Bluetooth Audio Options

-  - indicates that audio is routed to the Bluetooth headset.
-  - indicates that audio is routed to the speakerphone.
-  - indicates that audio is routed to the earpiece.

Dialer Dialing Options

The dialer provides options to save the dialed number to contacts, insert pauses and wait into the dial string and options for setting the Call settings. Enter at least one digit to access these options. Touch  to access the following.

- **Add to contacts** – Add the dialed number to the Contacts application.
- **Add 2–sec pause** - Pause the dialing of the next number for two seconds. Multiple pauses can be added sequentially.
- **Add wait** - Wait for confirmation to send the rest of the digits.
- **Send text message** - Send a text message.

Making a Call Using Contacts

There are two ways to make a call using contacts:

- Using the Dialer
- Using the Contacts application.

Using the Dialer

1. On the Home screen touch .
2. Touch the **CONTACTS** tab.

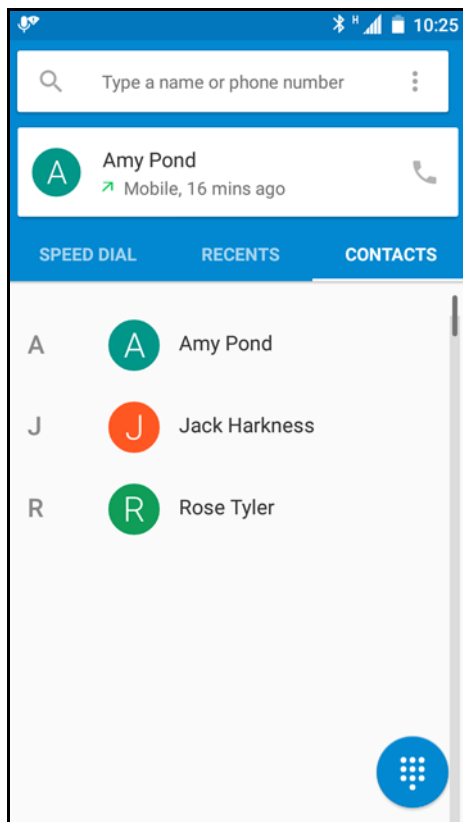



Figure 3-4 *Dialer Contacts Tab*

3. Touch a contact name.
4. Touch a phone number to initiate a call.
5. Touch  to end the call.

Using the Contacts application

1. On the Home screen touch .

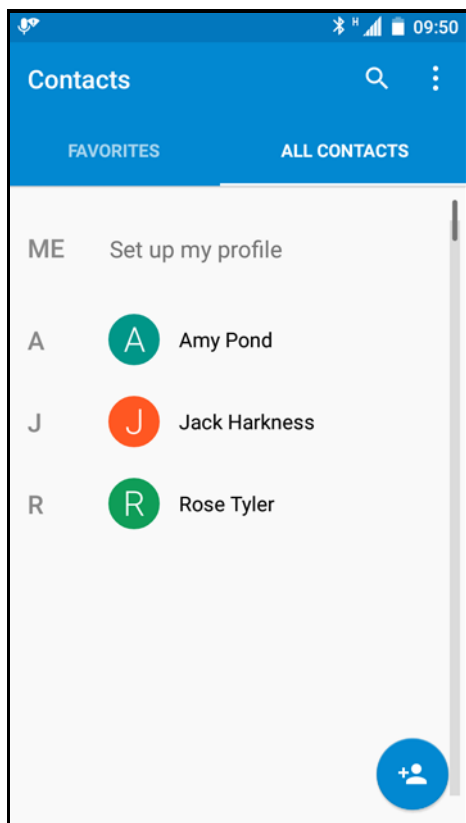

Figure 3-5 *Contact Application*

2. Touch a contact name.

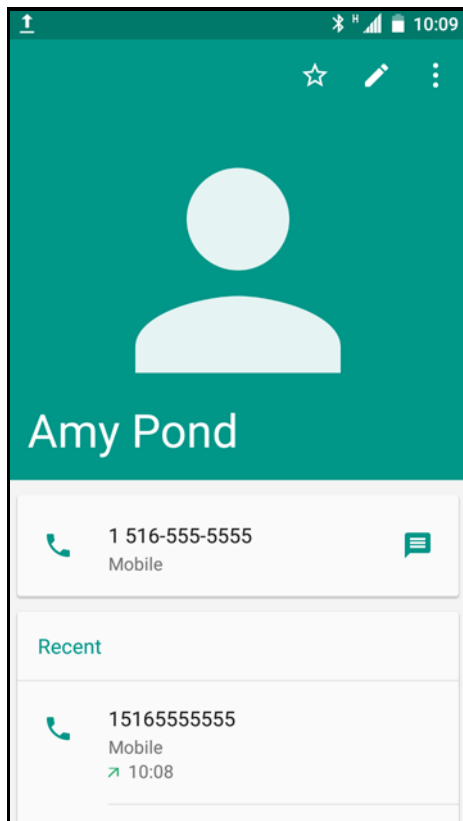





Figure 3-6 *Contact Application*

3. Touch a phone number to initiate a call.
4. Touch  to end the call.

Making a Call Using Call History

Call History is a list of all the calls placed, received, or missed. It provides a convenient way to redial a number, return a call, or add a number to Contacts.

Arrow icons beside a call indicate the type of call. Multiple arrows indicate multiple calls:

-  - Missed incoming call
-  - Received incoming call
-  - Outgoing call.

1. On the Home screen touch .
2. Touch the **RECENTS** tab.

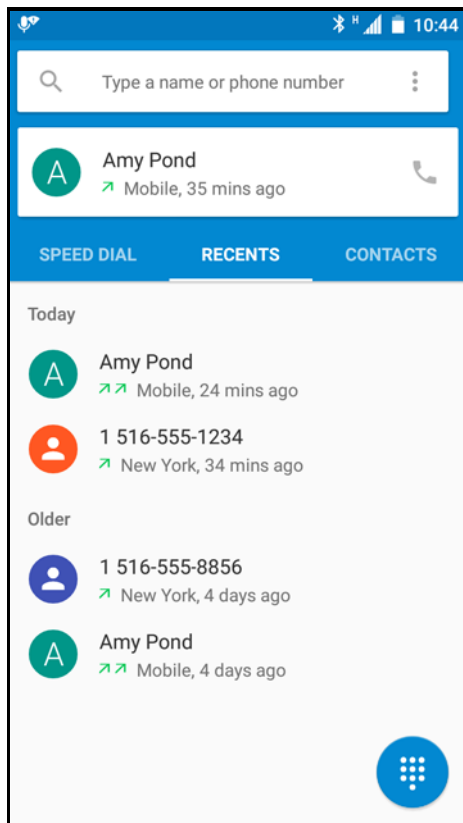







Figure 3-7 Recent Calls Tab

3. Touch a contact name.
4. Touch a phone number to initiate a call.
5. Touch  to end the call.

Making a Conference Call

To create a conference phone session with multiple people.

- ✓ **NOTE** Conference Calling and the number of conference calls allowed may not be available on all services. Please check with the service provider for Conference Calling availability.

1. On the Home screen touch .
2. Touch .
3. Touch the keys to enter the phone number.
4. Touch  below the dialer to initiate the call.
5. When the call connects, touch .
The first call is placed on hold.
6. Touch the keys to enter the second phone number.

7. Touch  below the dialer to initiate the call.
8. When the call connects, the first call is placed on hold and the second call is active.

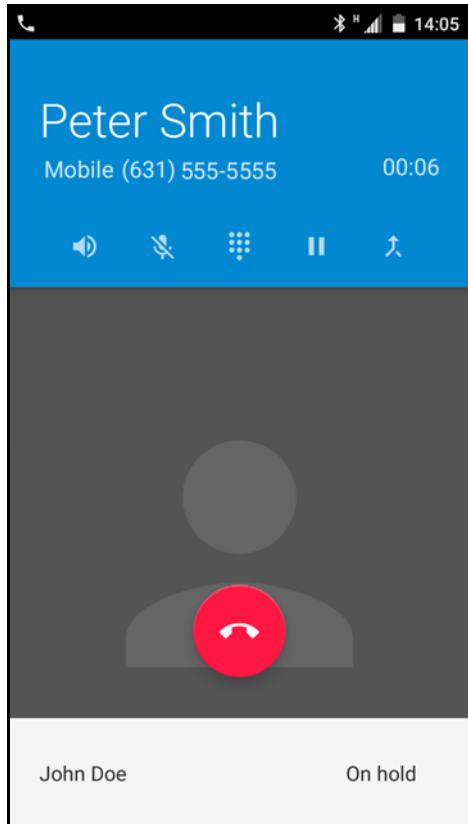



Figure 3-8 *Two Calls*

9. Touch  icon to create a conference call with three people.

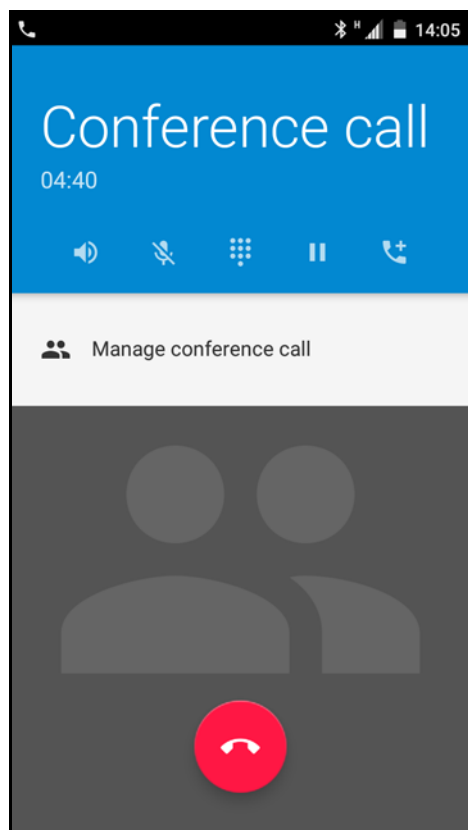





Figure 3-9 *Merged Calls*

10. Touch  to add another call.
The conference is placed on hold.
11. Touch the keys to enter the second phone number.
12. Touch  below the dialer to initiate the call.
13. Touch  icon to add the third call to the conference.
14. Touch **Manage Conference** to view all callers.

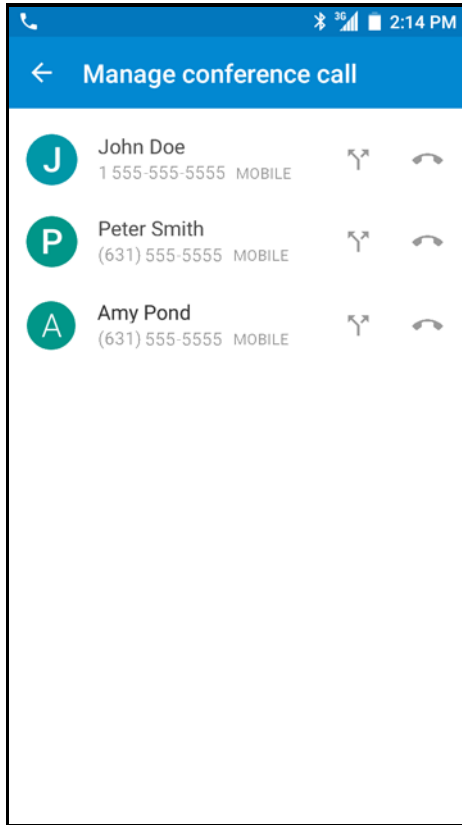





Figure 3-10 Un-merge Calls

15. To remove a caller from the conference, touch  next to the caller.

To speak privately with one party during a conference call, touch  and then touch the caller. To include all parties again, touch .

Making a Call Using a Bluetooth Headset

To make a call using a Bluetooth headset:

1. Pair the Bluetooth headset with the device.
2. Press the Call button on the Bluetooth headset.
“Speak now” is heard from the Bluetooth headset and the **Voice Dialer** screen appears.
3. Say a command.

If ...	Then ...
You want to call a contact by name:	Say “Call (<i>name</i>).”
You want to call a number:	Say “Dial (<i>number</i>).”
If you want to call your voicemail:	Say “Call voicemail.”
If you want to call the previous caller:	Say “Redial.”

4. Press the Call button on the Bluetooth headset to end the call.

Answering Calls

When you receive a phone call, the **Incoming Call** screen opens, displaying the caller ID and any additional information about the caller that is in the **Contacts** application.

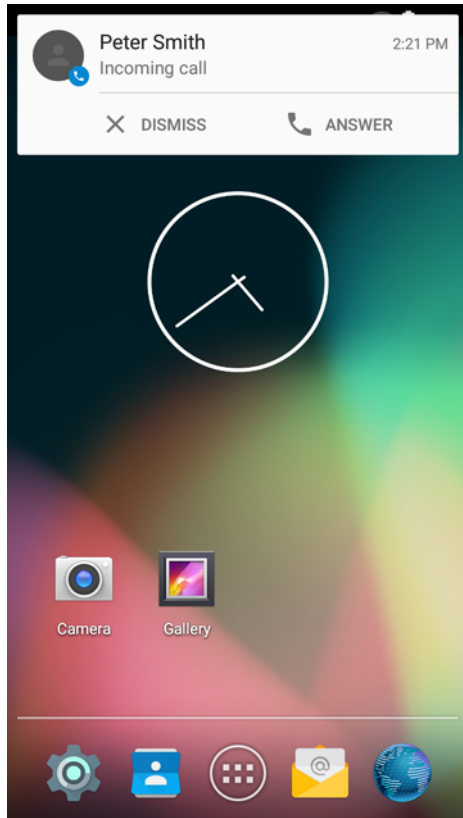

Figure 3-11 *Incoming Call Screen*

Touch **Answer** to answer the call or **Dismiss** to send the caller to voice mail.

If the screen lock is enabled, the user can still answer the call without unlocking the device.

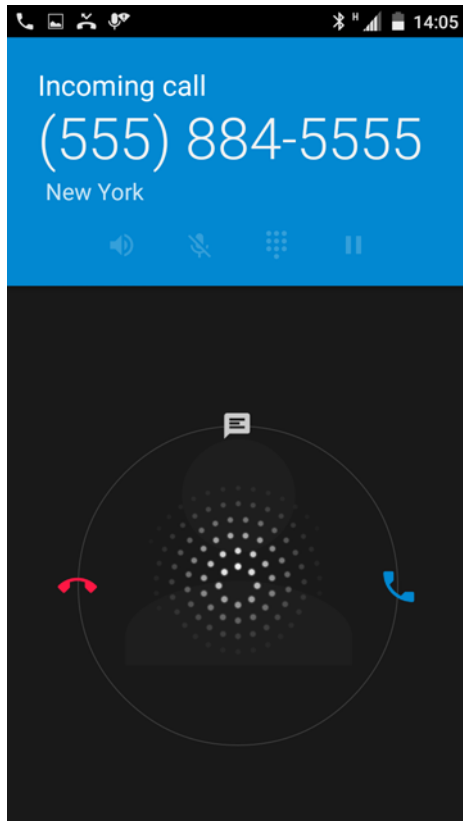





Figure 3-12 *Select Answer Options*

When a call arrives, touch the white phone icon and slide over one of these icons:

-  Answer call - Start talking to the caller.
-  Send to voice mail - Direct the caller to leave a voice mail message.
-  Send a message - Opens a list of quick text responses. Touch one to send it to the caller immediately.

When the calls ends, the device remains locked.

If using a Bluetooth headset, when a call arrives, touch the Call button on the Bluetooth headset to answer the call. To end the call press the headset Call button.

All incoming calls are recorded in the Phone application Call log tab. If you miss a call, you receive a notification. To silence the ringer before answering the call, press the volume down button on the side of device.

Call Settings

✓ **NOTE** Not all options are available for all configurations.

Use the Call Settings to modify options related to the phone call feature.

General settings

- Contact display options
 - **Sort by** - Touch to sort contacts by first or last name.
 - **Name format** - Touch to list contacts
- Sounds and vibrate
 - **Phone ringtone** - Touch to select a ringtone to sound when an incoming call is received.
 - **Dialpad tones** - Check to play a sound when a phone key is touched.
 - **Also vibrate for calls** - Check to make the device vibrate when a call is received.
- Other
 - **Quick responses** - Touch to edit quick responses to use instead of answering a call.

Call settings

- **Phone Account Settings**
 - SIP accounts
 - Use SIP calling
 - For all calls
 - Only for SIP calls
 - Receive incoming calls
- **Voicemail** - Touch to configure voicemail settings.
 - **Service** - Set the service provider or other provider for voicemail service.
 - **Setup** - Touch to update the phone number used to access voicemail.
 - **Sound** - Touch to select a sound to play when a voicemail is received.
 - **Vibrate** - Set vibrate option. (default – disabled).
- **Fixed Dialing Numbers** - Use Fixed Dialing to restrict the phone to dial only the phone number(s) or area code(s) specified in a Fixed Dialing list.
- **TTY mode** - Touch to set the TTY setting. Use an optional teletypewriter (TTY) device with the TC75 to send and receive calls. Plug the TTY device into the TC75 headset jack and set the TC75 to operate in one of the TTY modes.



NOTE Use a TSB-121 compliant cable (provided by the TTY manufacturer) to connect the TTY device to the TC75.

Set the TC75 volume to a middle level setting for proper operation. If you experience a high number of incorrect characters, adjust the volume as needed to minimize the error rate.

For optimal performance, the TC75 should be at least 30 cm (12 inches) from the TTY device. Placing the TC75 too close to the TTY device may cause high error rates.

- **TTY off** (default) - TTY is off.
- **TTY Full** - Transmit and receive TTY characters.
- **TTY HCO** - Transmit TTY characters but receive by listening to earpiece.
- **TTY VCO** - Receive TTY characters but transmit by speaking into microphone.
- **DTMF tones** - Touch to set the length of the DTMF tones. Options: **Normal** (default) or **Long**.

- Additional call settings
 - **Call forwarding** - Use call forwarding to forward incoming calls to a different phone number.



NOTE Call Forwarding may not be available on all networks. Check with the service provider for availability.

- **Always forward** - set to forward all calls to a different phone number.
- **Forward when busy** - enter the phone number to forward calls only when the line is busy.
- **Forward when unanswered** - enter the phone number to forward calls only when the phone cannot be answered.
- **Forward when unreachable** - enter the phone number to forward calls only when the phone is turned off or the user is unreachable.
- **Call barring** - Use call barring to block certain types of incoming and/or outgoing calls. Select the type of incoming and/or outgoing calls to block.
- **Additional settings**
 - **Caller ID** - Enable caller ID to reveal the identity of the person making an outgoing call. Options: **Network default** (default), **Hide number**, **Show number**.
 - **Call waiting** - Check to enable.
- **Internet Call Settings**
 - **SIP Accounts** - Choose to receive Internet calls for accounts added to the device, view or change SIP accounts, or add an Internet calling account.
 - **Use Internet calling** - Use Internet calling for all calls, only for calls to Internet calling addresses (the default Callssetting), or to ask for each call. Must be connected to a Wi-Fi network and have added an Internet calling account to the device to use Internet calling.
 - **IMS Account** - Select to enable or disable IMS Service capability.

CHAPTER 4 APPLICATIONS

Introduction

This chapter describes the applications installed on the device.

Battery Manager

The Battery Manager provides detailed information about the battery.

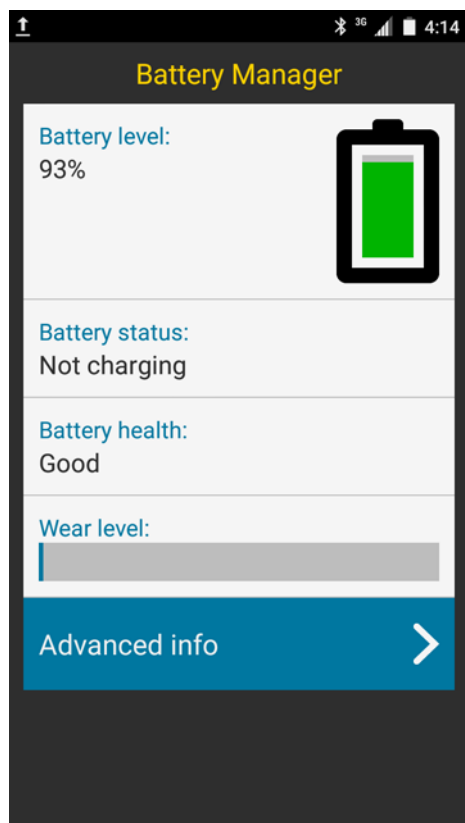

Figure 4-1 *Battery Manager Screen*

Battery level - Indicate the current battery charge level.

Time until empty - Indicates the amount of time before the battery is depleted. Displays when the WT6000 is not on AC power.

Time until full - Indicates the amount of time until the battery is fully charged. Displays when the WT6000 is on AC power.

- **Battery status**
 - **Not charging** - Indicates that the WT6000 is not connected to AC power.
 - **Charging over AC** - Indicates that the WT6000 is connected to AC power and charging.
- **Battery health** - Indicates the health of the battery.
- **Wear level** - Indicates the health of the battery in graphical form.
- **Advanced info** - Tap to view additional battery information.

File Browser

Use the **File Browser** application to view and manage files on the device.

To open **File Browser**, touch  > .

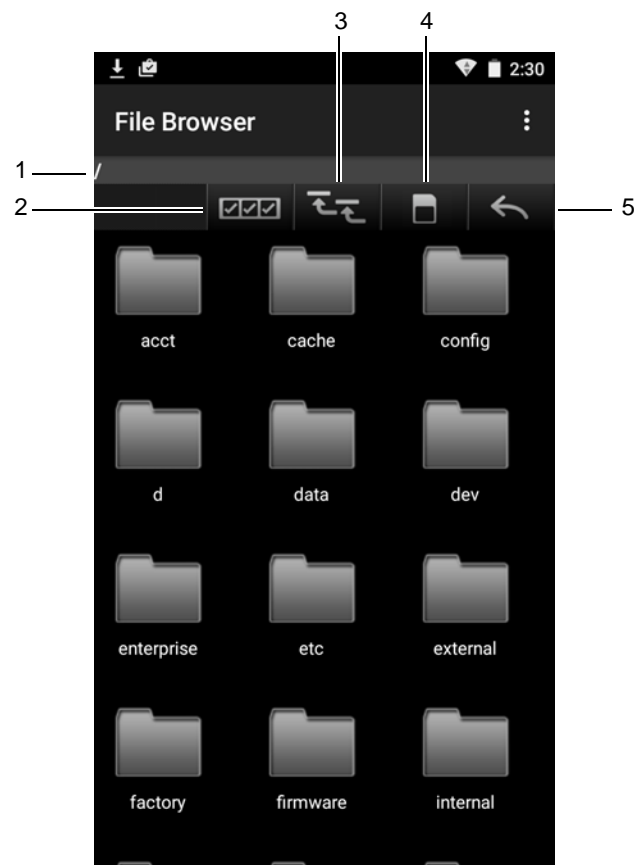





Figure 4-2 *File Browser Screen*

The address bar (1) indicates the current folder path. Touch the current folder path to manually enter a path and folder name.

Use  (2) to select multiple files/folder.

Use  (3) to view the internal storage root folder.

Use  (4) to view the microSD card root folder.

Use  (5) to view the previous folder or to exit the application.

Touch and hold an item to perform an operation on that item. Select one of the options from the **File Operations** menu:

- **Information** - View detailed information about the file or folder.
- **Move** - Move the file or folder to a new location.
- **Copy** - Copy the select file.
- **Delete** - Delete the selected file.

- **Rename** - Rename the select file.
- **Open as** - Open the selected file as a specific file type.
- **Share** - Share the file with other devices.

Messaging

Use Messaging to send and receive SMS and MMS messages. From a Home or **Apps** screen, touch .

Sending a Text Message

1. In the main Messaging screen, touch .

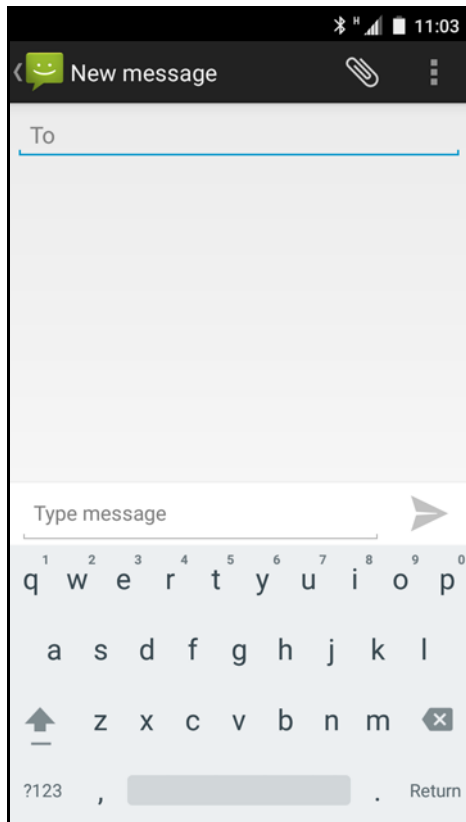





Figure 4-3 *New Text Message Screen*

2. In the **To** field, enter a name or a mobile phone number.
3. In the **Type message** field, enter the text message.
The 160-character limit counter indicates how many characters are left. If it goes over that limit, a new message is created, which is joined with its predecessors when received.
If the user presses the Back button while composing a message, it's saved as a draft in the Messaging screen. Touch the conversation to resume composing it.
4. Touch  to send the message.

Sending a Multimedia Message

1. In the main Messaging screen, touch .
2. In the **To** field, enter a name or a mobile phone number.
3. Touch  to attach the media file of your choice:

- **Pictures.** Select a picture to attach.
 - **Capture picture.** Camera opens to take a picture and attach it.
 - **Videos.** Select a video to attach.
 - **Capture video.** Camcorder opens to record a video and attach it to the message.
 - **Audio.** Choose a sound file to attach.
 - **Record audio.** Sound Recorder opens to record a spoken message and attach it to the message.
 - **Slideshow.** Opens a screen opens to assemble text, photos, videos, and recordings into a slideshow of up to 10 slides to attach to the message.
 - **Contacts.** Send a contact's information.
4. Touch  to send the message.

Contacts



Use the **Contacts** application to manage contacts.

From a Home or **Apps** screen, touch . **Contacts** opens to the main list of contacts. View contacts in two ways at the top of the screen: Favorites and All Contacts. Touch the tabs to change how to view the contacts. Swipe up or down to scroll through the lists.

Adding Contacts

1. In the **Contacts** application, touch .
2. If there are more than one account with contacts, touch the one to use.
3. Type the contact's name and other information. Touch a field to start typing, and swipe down to view all categories.
4. To add more than one entry for a category – for example, to add a work address after typing a personal address – touch **Add new** for that field. To open a menu with preset labels, such as Home or Work for an email address, touch the label to the right of the item of contact information. Or, to create your own label, scroll to the bottom of the contact page and touch **Add Another Field**.
5. Touch **Done**.

Editing People

1. In the **Contacts** application, touch a person to edit.
2. Touch  **Edit**.
3. Edit the contact information.
4. Touch  **Done**.

Deleting People

1. In the **Contacts** application, touch a person to edit.
2. Touch .
3. Touch **Delete**.
4. Touch **OK** to confirm.

Camera

This section provides information for taking photos and recording videos using the integrated digital cameras.

- ✓ **NOTE** If a microSD card is installed, The TC75 saves photos and videos on the microSD card. If a microSD card is not installed, the TC75 saves photos and videos on the internal storage.

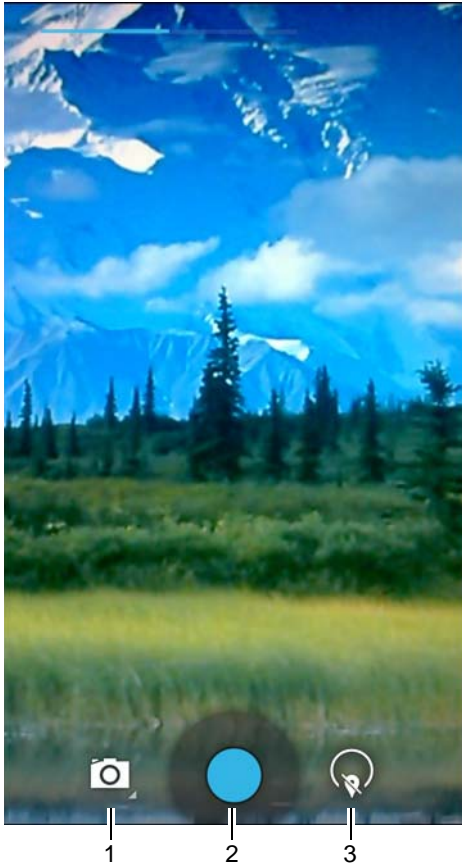



Figure 4-4 Camera Photo Screen

1	Camera Options — Touch to select Camera, Video or Panorama mode.
2	Shutter button - Touch to take a photo, a panoramic photo or to record a video.
3	Photo Settings – Touch to select camera settings.

Taking Photos

- ✓ **NOTE** Camera settings are described in [Photo Settings on page 4-13](#).

1. Touch .
2. Touch .

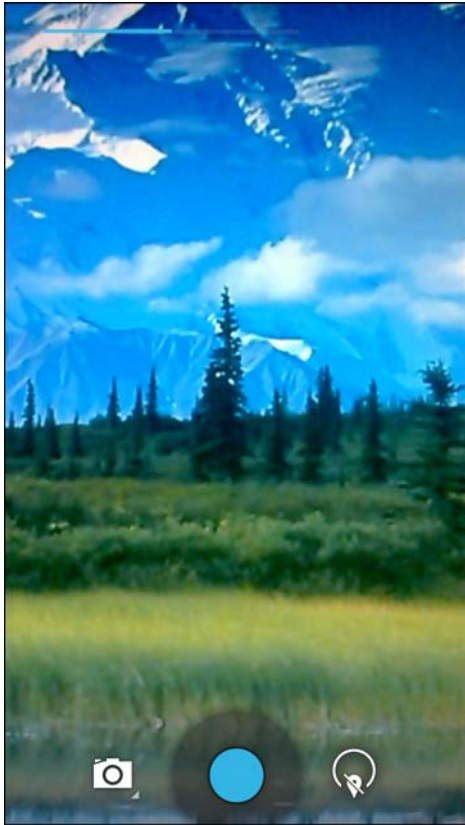





Figure 4-5 *Camera Mode*

3. If necessary, touch the camera options icon and touch .
4. To switch between the rear camera and front camera, touch  and then  or .
5. Frame the subject on the screen.
6. To zoom in or out, press two fingers on the display and pinch or expand fingers. The zoom controls appear on the screen.

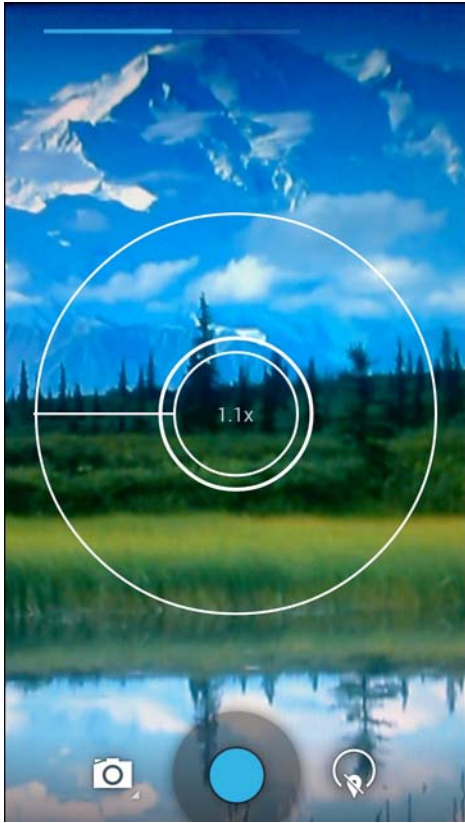





Figure 4-6 *Camera Zoom*

7. Touch an area on the screen to focus. The focus circle appears on the screen. The two horizontal bars turn green when in focus.
8. Touch .
The camera takes a photo and a shutter sound plays.

Alternately, touch  and hold to focus first, before taking a photo; then release to take a focused photo.
The photo momentarily displays as a thumbnail in the upper right corner.

Taking a Panoramic Photo

Panorama mode lets the user create a single wide image by panning slowly across a scene.

1. Touch .
2. Touch .

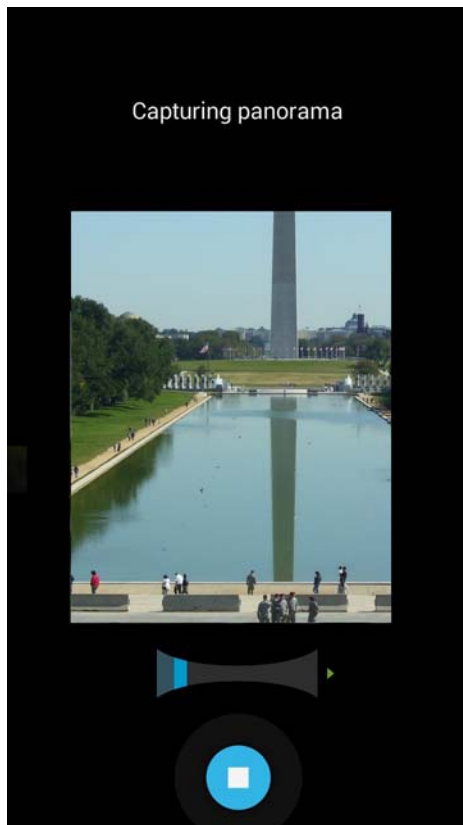







Figure 4-7 *Panoramic Mode*

3. Touch the options bar and touch .
4. Frame one side of the scene to capture.
5. Touch  and slowly start panning across the area to capture. A small white square appears inside the button indicating the capture is in progress.
If panning too quickly, the message **Too fast** appears.
6. Touch  to end the shot. The panorama appears immediately and a progress indicator displays while it saves the image.

Recording Videos

To record a video:

1. Touch .
2. Touch .

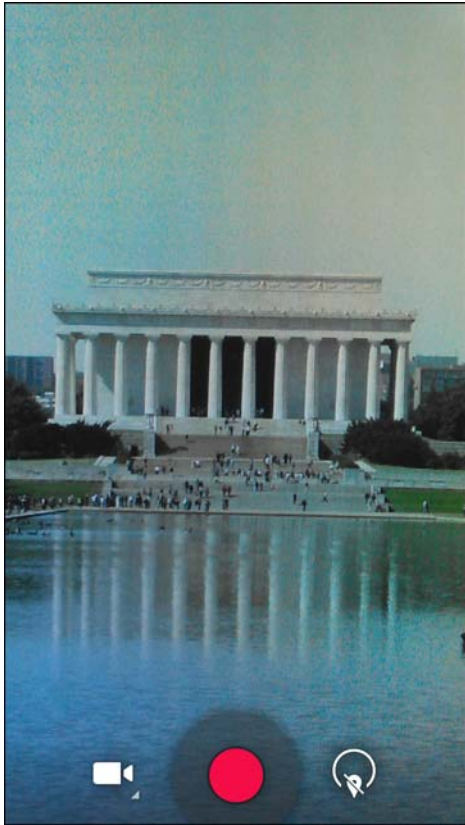





Figure 4-8 *Video Mode*

3. Touch the options bar and touch .
4. To switch between the rear camera and front camera, touch  and then  or .
5. Point the camera and frame the scene.
6. To zoom in or out, press two fingers on the display and pinch or expand fingers. The zoom controls appear on the screen.

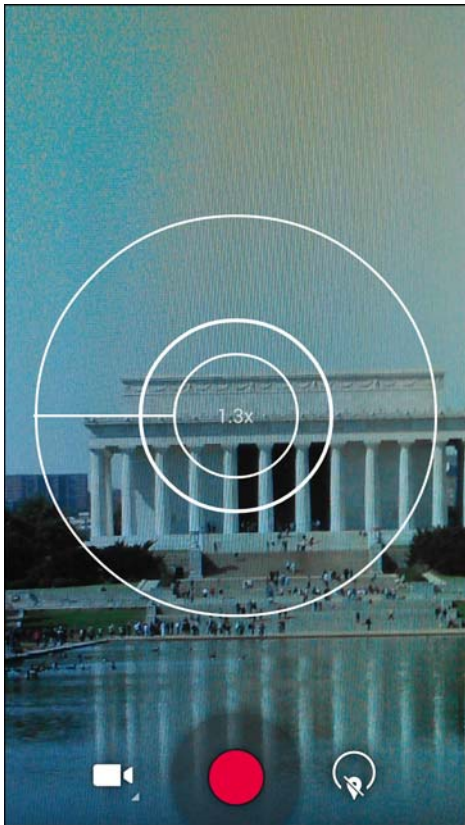

Figure 4-9 Camera Zoom





7. Touch  to start recording.
The device starts recording the video. The video time remaining appears in the top left of the screen.
8. Touch  to end recording.
The video momentarily displays as a thumbnail in the upper right corner.

Photo Settings

When in Photo mode, photo settings are displayed on screen. Touch  to display the photo settings options.

Rear Camera

Touch  to display the photo setting options.

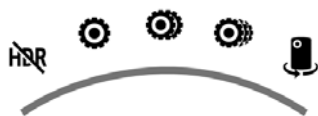















Figure 4-10 Rear Photo Setting Options

- **HDR** – Touch to enable High Dynamic Range (HDR) imaging. HDR adds more dynamic range to photographs (the ratio of light to dark). HDR uses three photos, taken at different exposures to create the photo (default - disabled).

- :
 - **Scene mode** - Touch to select a preset combination of camera settings designed for specific scenes. Options: **Auto** (default), **Night**, **Portrait**, **Landscape**, **Steady Photo**, **Sports** or **Document capture**.
 - **Store location** – Touch to add location information to the photo. (default – disabled)
 - **Picture size** - Touch to set the size (in pixels) of the photo. Options: **8M pixels** (default), **5M pixels**, **3M pixels**, **HD 1080p**, **2M pixels**, **HD 720p**, **1M pixels**, **WVGA**, **VGA** or **QVGA**.
 - **Picture quality** - Touch to select picture quality setting. Options: **Super fine** (default), **Fine** or **Normal**.
 - **ZSL** - Set the camera to immediately take a picture when the button is pressed (default – disabled)
 - **Countdown timer** - Options: **Off** (default), **1 second**, **2 seconds**, **3 seconds**, **4 seconds**, **5 seconds**, **10 seconds**, **15 seconds**, **20 seconds**, **30 seconds** or **60 seconds**.
 - **Beep during countdown** - Select to play a beep tone during countdown (default – enabled).
 - **Storage Position** - Touch to select the storage location. Options: **Phone** or **SD Card** (default).
 - **Auto HDR** - Touch to enable High Dynamic Range photography (default - disabled).
- :
 - **Face detection** - Select to enable face detection (default – enabled).
 - **Touch AF/AEC** - Select to enable auto focus (default – enabled).
 - **Sharpness** - Touch to select a sharpness level. Options: **Level 0**, **Level 1**, **Level 2**, **Level 3** (default), **Level 4**, **Level 5** or **Level 6**.
 - **Select Auto Exposure** - Touch to select auto exposure setting. Options: **Frame Average** (default), **Center Weighted** or **Spot Metering**.
- :
 - **Anti Banding** - Options: **Off**, **50 Hz**, **60 Hz** or **Auto** (default).
 - **Select ISO** - Set how sensitive the camera is to light. Options: **Auto** (default), **ISO Auto (HJR)**, **ISO100**, **ISO200**, **ISO400**, **ISO800** or **ISO1600**.
 - **Exposure** - Touch to adjust the exposure settings. Options: **+2**, **+1**, **0**(default), **-1** or **-2**.
 - **White balance** - Touch to select how Camera adjusts colors in different kinds of light, to achieve the most natural-looking colors.
 -  **Incandescent** - Adjust the white balance for incandescent lighting.
 -  **Fluorescent** - Adjust the white balance for florescent lighting.
 -  **Auto** - Adjust the white balance automatically (default).
 -  **Daylight** - Adjust the white balance for daylight.
 -  **Cloudy** - Adjust the white balance for a cloudy environment.
 - **Flash mode** - Touch to set whether Rear-facing Camera relies on its light meter to decide whether a flash is necessary, or to turn it on or off for all shots.
 -  **Off** - Disable flash.
 -  **Auto** - Camera adjusts flash automatically depending upon light meter (default).
 -  **On** - Enable flash upon taking a photo.

-  **Torch** - Turn flash on continuously.
- **Focus Mode** - Touch to select the camera focus setting. Options: **Auto** (default), **Infinity**, **Macro** or **CAF** (Continuous Auto Focus).
- **AE-Bracket** - Touch to set Automatic Exposure Bracketing (default – disabled).
-  – Touch to switch to the front camera.

Front Camera





Touch  to display the photo setting options.



Figure 4-11 *Front Photo Setting Options*

- :
 - **Store location** – Touch to add location information to the photo. (default – disabled)
 - **Picture size** - Touch to set the size (in pixels) of the photo. Options: **HD 720p** (default), **1M pixels**, **WVGA**, **VGA** or **QVGA**.
 - **Picture quality** - Touch to select picture quality setting. Options: **Super fine** (default), **Fine** or **Normal**.
 - **Countdown timer** - Options: **Off** (default), **1 second**, **2 seconds**, **3 seconds**, **4 seconds**, **5 seconds**, **10 seconds**, **15 seconds**, **20 seconds**, **30 seconds** or **60 seconds**.
 - **Beep during countdown** - Select to play a beep tone during countdown (default – enabled).
 - **Storage Position** - Touch to select the storage location. Options: **Phone** or **SD Card** (default).
 - **Auto HDR** - Touch to enable High Dynamic Range photography (default - disabled).
- :
 - **Face detection** - Select to enable face detection (default – enabled).
-  – Touch to switch to the rear camera.

Video Settings









When in Video mode, video settings are displayed on screen. Touch  to display the video settings options.

Rear Camera

Touch  to display the photo setting options.



Figure 4-12 *Rear Video Setting Options*

- 
 - **Time lapse** - Touch to select a time interval to set the frame rate for time lapse photography. Options: **Off** (default), Slide switch to **ON** and then set time interval.
 - **Video quality** - Touch to select video quality:
 - **HD 1080p** - High definition 1080p (default).
 - **HD 720p** - High definition 720p.
 - **SD 480p** - Standard definition 480p.
 - **Video duration** - Options: **30 seconds (MMS)** or **30 minutes** (default).
 - **Store location** – Touch to add location information to the photo. (default – disabled).
 - **Store Position**– Touch to select the storage location. Options: **Phone** or **SD Card** (default).
- 
 - **White balance** - Touch to select how Camera adjusts colors in different kinds of light, to achieve the most natural-looking colors.
 -  **Incandescent** - Adjust the white balance for incandescent lighting.
 -  **Fluorescent** - Adjust the white balance for florescent lighting.
 -  **Auto** - Adjust the white balance automatically (default).
 -  **Daylight** - Adjust the white balance for daylight.
 -  **Cloudy** - Adjust the white balance for a cloudy environment.
 - **Flash mode** - Select to turn on flash (default – disabled).
 -  – Touch to switch to the front camera.

Front Camera



Touch  to display the photo setting options.



Figure 4-13 *Front Video Setting Options*

- 
 - **Time lapse** - Touch to select a time interval to set the frame rate for time lapse photography. Options: **Off** (default), Slide switch to **ON** and then set time interval.
 - **Video quality** - Touch to select video quality:
 - **HD 720p** - High definition 720p (default).
 - **SD 480p** - Standard definition 480p.
 - **Video duration** - Options: **30 seconds (MMS)** or **30 minutes** (default).
 - **Store location** – Touch to add location information to the photo. (default – disabled).
 - **Storage Position** - Touch to select the storage location. Options: **Phone** or **SD Card** (default).
-  – Touch to switch to the rear camera.

Gallery





NOTE The device supports the following image formats: jpeg, gif, png and bmp.

The device supports the following video formats: H.263, H.264 and MPEG4 Simple Profile.

Use Gallery to:

- view photos
- play videos
- perform basic editing of photos
- set photos as wallpaper
- set photos as a contact photo
- share photos and videos.

To open the Gallery application, touch  >  or in the camera application touch the thumbnail image at the top right.

Gallery presents all photos and videos stored on the microSD card and internal memory.

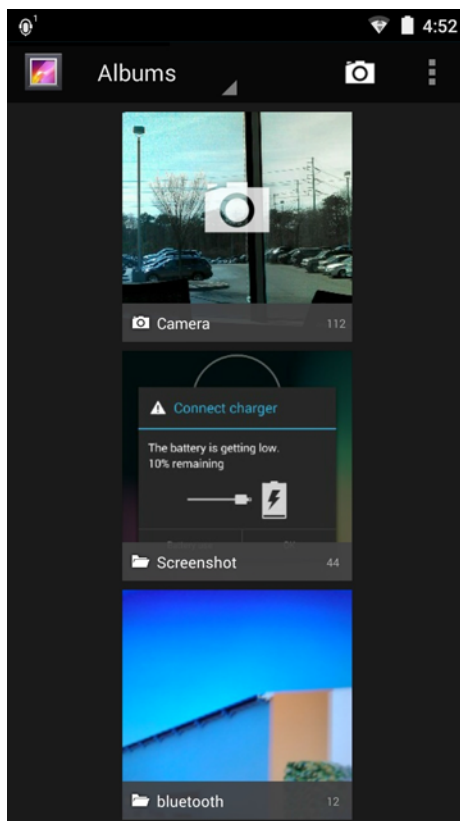



Figure 4-14 *Gallery — Albums*

- Touch an album to open it and view its contents. The photos and videos in the album are displayed in chronological order.
- Touch a photo or video in an album to view it.

- Touch  to return to the main **Gallery** screen.

Working with Albums



Albums are groups of images and videos in folders. Touch an album to open it. The photos and videos are listed in a chronologically ordered grid. The name of the album displays at the top of the screen.





Figure 4-15 *Photos Inside an Album*

Swipe left or right to scroll images across the screen.

Share an Album



1. Touch  > .
2. Touch and hold an album until it highlights.
3. Touch other albums as required.
4. Touch . The Share menu opens. Touch the application to use to share the selected albums.
5. Follow the instructions within the selected application.

Get Album Information

1. Touch  > .
2. Touch and hold an album until it highlights.
3. Touch  > **Details**.

Deleting an Album

To delete an album and its contents:

1. Touch  > .
2. Touch and hold an album until it highlights.
3. Check other albums to delete. Ensure that other albums are selected.
4. Touch  **Delete**.
5. In the **Delete selected item?** menu, touch **OK** to delete the album.

Working with Photos

Use Gallery to view photos on the microSD card and edit and share photos.

Viewing and Browsing Photos

To view a photo:

1. Touch  > .
2. Touch an album to open it.
3. Touch a photo.

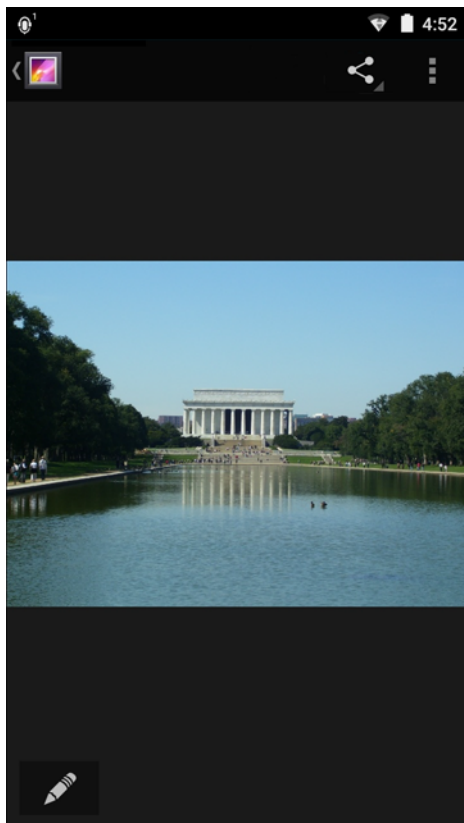



Figure 4-16 *Photo Example*

4. Swipe left or right to view the next or previous photo in the album.

5. Turn the device to view the photo in upright (portrait) or sideways (landscape) orientation. The photo is displayed (but not saved) in the new orientation.
6. Touch the photo to view the controls.
7. Double-tap the screen to zoom in or pinch two fingers together or spread them apart to zoom in or out.
8. Drag the photo to view parts that are not in view.

Cropping a Photo

1. In Gallery, touch a photo to view the controls.
2. Touch .
3. Touch **Crop**. The cropping tool appears.
4. Use the cropping tool to select the portion of the photo to crop.
 - Drag from the inside of the cropping tool to move it.
 - Drag an edge of the cropping tool to resize it to any proportion.
 - Drag a corner of the cropping tool to resize it with fixed proportions.

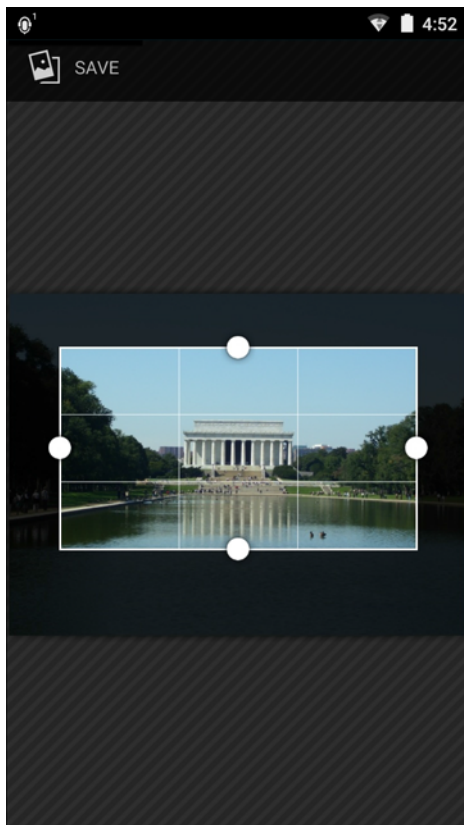



Figure 4-17 *Cropping Tool*



5. Touch **Save** to save a copy of the cropped photo. The original version is retained.

Setting a Photo as a Contact Icon



1. Touch  > .
2. Touch an album to open it.

3. Touch the photo to open it.
4. Touch .
5. Touch **Set picture as**.
6. Touch **Contact photo**.
7. In the **Contacts** application, touch a contact.
8. Crop the photo accordingly.
9. Touch **SAVE**.

Share a Photo

1. Touch  > .
2. Touch an album to open it.
3. Touch a photo to open it.
4. Touch .
5. Touch the application to use to share the selected photo. The application selected opens with the photo attached.



Deleting a Photo

1. Touch  > .
2. Touch an album to open it.
3. Touch a photo to open it.
4. Touch  > **Delete**.
5. In the **Delete selected item?** menu, touch **OK** to delete the album.

Working with Videos

Use **Gallery** to view videos and share videos.

Watching Videos

1. Touch  > .
2. Touch an album to open it.
3. Touch a video.

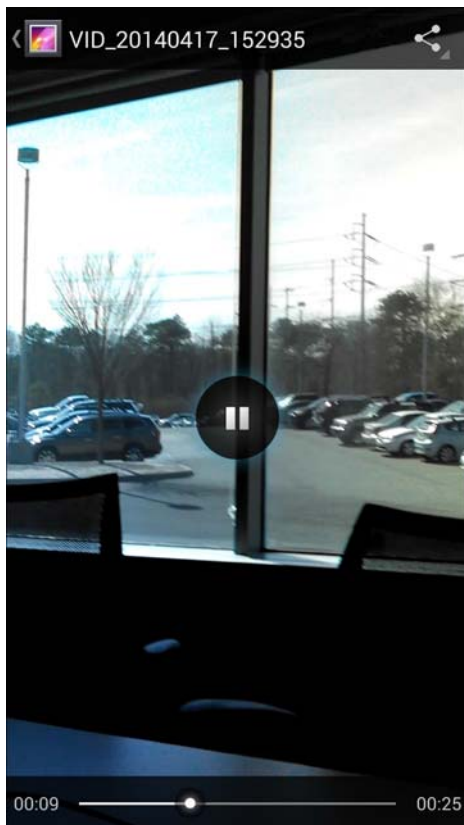









Figure 4-18 Video Example

4. Touch . The video begins to play.
5. Touch the screen to view the playback controls.

Sharing a Video

1. Touch  > .
2. Touch an album to open it.
3. Touch a video to open it.
4. Touch . The Share menu appears.
5. Touch the application to use to share the selected video. The application selected opens with the video attached.

Deleting a Video

1. Touch  > .
2. Touch an album to open it.
3. Touch a video to open it.
4. Touch  > **Delete**.
5. In the **Delete selected item?** menu, touch **OK** to delete the album.

DataWedge Demonstration

✓ **NOTE** DataWedge is enabled when on the Home screen displays. To disable this feature, go to the DataWedge settings and disable the **Launcher** profile.

Use **DataWedge Demonstration** to demonstrate data capture functionality.

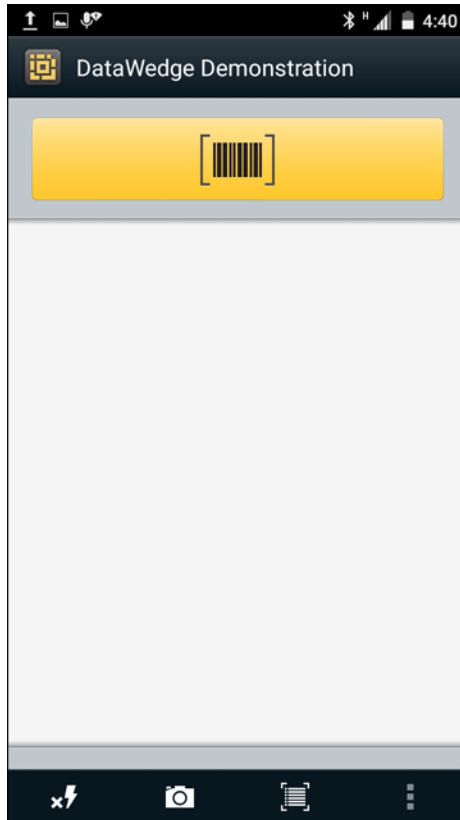

Figure 4-19 *DataWedge Demonstration Window*

Table 4-1 *DataWedge Demonstration Icons*









Icon	Description
	Select to disable imager illumination.
	Select to enable imager illumination.
	Indicates that the data capture function is through the camera.
	Indicates that the data capture function is through the imager.
	Indicates that a Bluetooth imager is connected to the TC75.

Table 4-1 *DataWedge Demonstration Icons (Continued)*

Icon	Description
	Select to enable picklist mode.
	Select to enable normal scan mode.
	Opens a menu to view the application information or to set the application DataWedge profile.



NOTE See the TC75 Integrator Guide for information on DataWedge configuration.

Either press the programmable button or touch the yellow scan button to enable data capture. The captured data appears in the text field below the yellow button.

Sound Recorder

Use **Sound Recorder** to record audio messages.

Recordings are saved on the microSD card (if installed) or the Internal Storage and available in the Music application playlist titled “My recordings.”

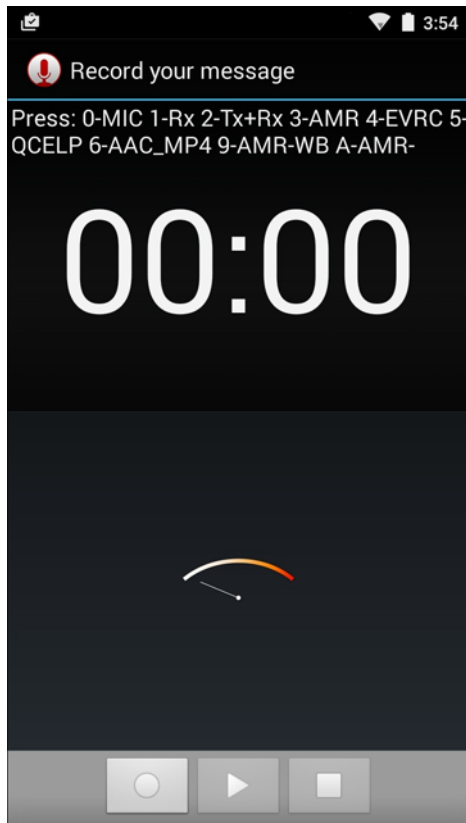

Figure 4-20 *Sound Recorder Application*

PTT Express Voice Client

✓ **NOTE** PTT Express Voice Client creates Push-To-Talk (PTT) communication capability between disparate enterprise devices. Leveraging existing Wireless Local Area Network (WLAN) infrastructure, PTT Express delivers simple PTT communication without the need of a voice communication server.

- **Group Call:** Press and hold the PTT (Talk) button to start communicating with other voice client users.

PTT Audible Indicators

The following tones provide helpful cues when using the voice client.

- **Talk Tone:** Double chirp. Plays when the Talk button is depressed. This is a prompt for the user to start talking.
- **Access Tone:** Single beep. Plays when another user just finished a broadcast or response. The user is now able to initiate a Group Broadcast or Private Response.
- **Busy Tone:** Continuous tone. Plays when the Talk button is depressed and another user is already communicating on the same talkgroup. Plays after the maximum allowed talk time is reached (60 seconds).
- **Network Tone:**
 - Three increasing pitch beeps. Plays when PTT Express has acquired the WLAN connection and the service is enabled.
 - Three decreasing pitch beeps. Plays when PTT Express has lost the WLAN connection or the service is disabled.

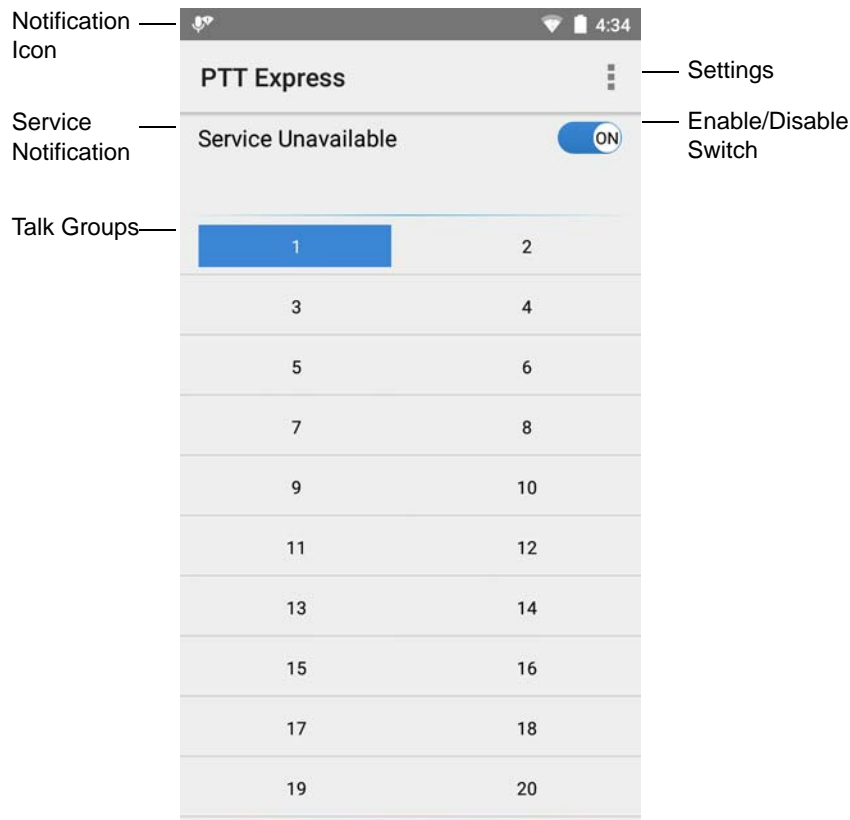

Figure 4-21 PTT Express Default User Interface







Table 4-2 PTT Express Default User Interface Descriptions

Item	Description
Notification Icon	Indicates the current state of the PTT Express client.
Service Indication	Indicates the status of the PTT Express client. Options: Service Enabled , Service Disabled or Service Unavailable .
Talk Groups	Lists all 32 Talk Groups available for PTT communication.
Settings	Opens the PTT Express Settings screen.
Enable/Disable Switch	Turns the PTT service on and off.



Notification Icons

Indicates the current state of the PTT Express Voice client.

Table 4-3 PTT Express Default User Interface Descriptions

Status Icon	Description
	Indicates that PTT Express Voice client is disabled.
	Indicates that PTT Express Voice client is enabled but not connected to a WLAN.
	Indicates that PTT Express Voice client is enabled, connected to a WLAN and listening on the Talk Group indicated by the number next to the icon.
	Indicates that PTT Express Voice client is enabled, connected to a WLAN and communicating on the Talk Group indicated by the number next to the icon.
	Indicates that PTT Express Voice client is enabled, connected to a WLAN and in a private response.
	Indicates that PTT Express Voice client is enabled and muted.
	Indicates that the PTT Express Voice client is enabled but it is not able to communicate due to a VoIP telephony call is in progress.

Enabling PTT Communication

1. Touch .
2. Touch .
3. Slide the **Enable/Disable Switch** to the **ON** position. The button changes to an **ON** button.

Selecting a Talk Group

One of 32 Talk Groups can be selected by PTT Express users. However, only one talk group may be enabled at a time on the device. Touch one of the 32 Talk Groups. The selected Talk Group is highlighted.

PTT Communication

- ✓ **NOTE** This section describes the default PTT Express client configuration. See the *PTT Express V1.2 User Guide* for detailed information on using the client.

PTT communication may be established as a Group Call. When PTT Express is enabled, the PTT button on the left side of the device is assigned for PTT communication. When the Wired Headset is used, Group Calls can also be initiated using the headset Talk button.

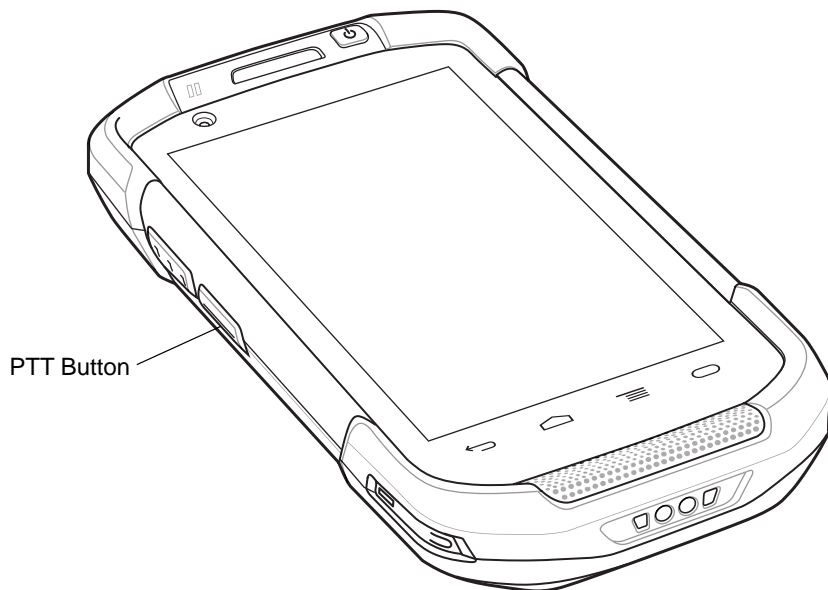

Figure 4-22 PTT Buttons

Creating a Group Call

1. Press and hold the PTT button (or the Talk button on the headset) and listen for the talk tone to play.
If a busy tone is heard, release the button and wait a moment before making another attempt. Ensure that PTT Express and the WLAN are enabled.
2. Start talking after the talk tone is heard.

✓ **NOTE** If the user holds the button for more than 60 seconds (default), the call is dropped allowing others to make Group calls. The user should release the button when finished talking to allow others to make calls.

3. Release the button when finished talking.

Disabling PTT Express Voice Client Communication

1. Touch .
2. Touch .
3. Slide the **Enable/Disable Switch** to the **OFF** position. The button changes to **OFF**.
4. Touch .

MLog Manager

Use **MLog Manager** to capture log files for diagnostics. See the *TC75 Integrator Guide* for detailed information on configuring the application.

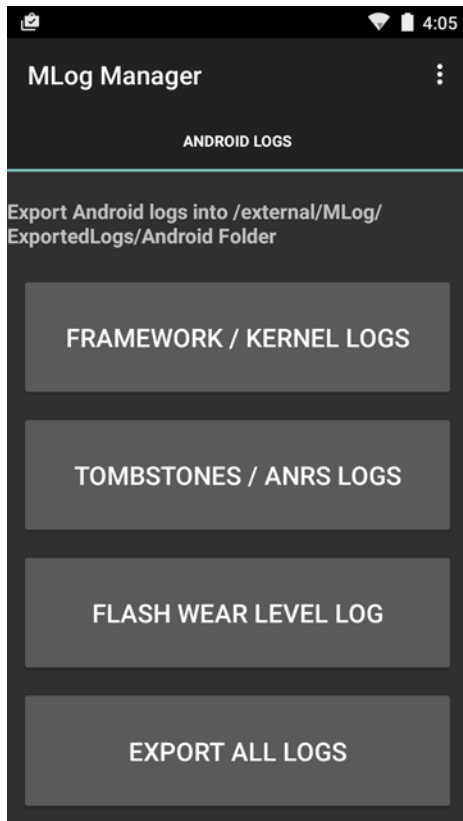

Figure 4-23 *MLog Manager*

SimulScan Demo

The SimulScan application is an out of the box demonstration application included on the device that support SimulScan. The application enables pre-sales personnel to showcase the various features of SimulScan to customers by employing use-cases in the two most popular verticals, Postal/Transportation and Logistics and Manufacturing. The Transportation and Logistics example showcases the OCR and OMR features. The Manufacturing example showcases the MultiCode 20 feature. SimulScan also allows customers to create templates using the Template Builder and then testing on the device.

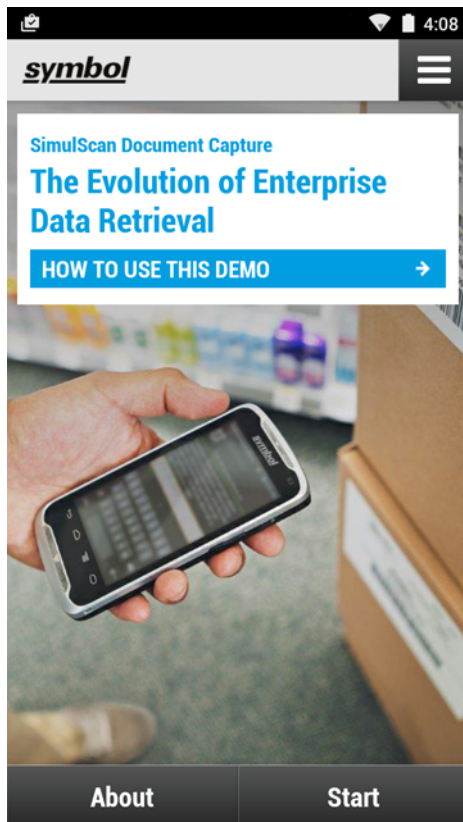

Figure 4-24 *SimulScan Demo Home Screen*

Exporting Sample Forms

In order to perform the Postal, Transportation & Logistics or Manufacturing demonstrations, print the example forms stored on the device.

1. Launch **SimulScan Demo** application.
2. On the **SimulScan Demo** home screen, touch **HOW TO USE THIS DEMO**.
3. Scroll down and touch **Export sample forms** button. The device copies the forms to the `\simulscan\samples` folder in Internal Storage.
4. Connect the device to a computer using the USB Charging cable.
5. Copy the files from the `\simulscan\samples` folder in Internal Storage to the computer.
6. Print the forms.

Postal, Transportation and Logistics Example

The Postal, Transportation and Logistics example uses the following form.:

1 Payee account number and insurance details

Change to Shipper Receiver 3rd party
Not all payment options are available in all countries.

Payee Account No. 00-1239876

Shipment Insurance was reviewed
 Yes (insurance value in local currency) 100

2 Non-Documents Shipments Only (Custom Requirement)

Match the original and true copies of a Reference Document make

Shipper's WU/USI number 564451112 Receiver's WU/USI or Shipper's EIN/SIN 111517738
 Harmonized Commodity Code (if applicable)

Destination countries/areas that have received your data/times
 Receiver Shipper Other
each shipment/account number

Declared Value for Customs (in an appropriate currency)
 Receiver Shipper Other

3 From (Shipper)

Shipper's account number 135-22263
 Company name Pura Theory Ltd

Address 163B Ladbroke Grove
 Fitzrovia, London
 England
 WC2 1JH

Contact name Scott Andrews
 Phone Fax or E-mail (required) 0077 553633

4 To (Receiver)

Company name TMN Solutions
 Delivery address Sovilla
 Trondheim
 72A 64 Brønna
 Postcode/City (required) 206 32 Country Sweden

Contact person Allan Peterson
 Phone Fax or E-mail (required) +46 8 123 89 87

5 Shipper's signature

Signature required
 I have checked myself a writing that given to the
 terms and Conditions of Change Shipment rules
 and (if such terms and conditions and other
 applicable, the Commission has and/or entails
 liability for loss, damage or delay and (2) has
 approved these and certain rules or documents
 good have received

Signature
 Date 10/10/13

POSTAL76L

Shipment Air Mail
 (Not registered)

123456789A

FORM 123456789

Figure 4-25 Postal, Transportation and Logistics Form

1. Place the form on a flat surface.
2. On the device, launch **SimulScan Demo** application.
3. Touch the **Menu** icon in the top right corner of the screen.
4. Touch **Postal, Transportation & Logistics**.
5. Touch **Start SimulScan**.
6. Use the image control at the bottom of the screen to control the flash, audio and zoom level.

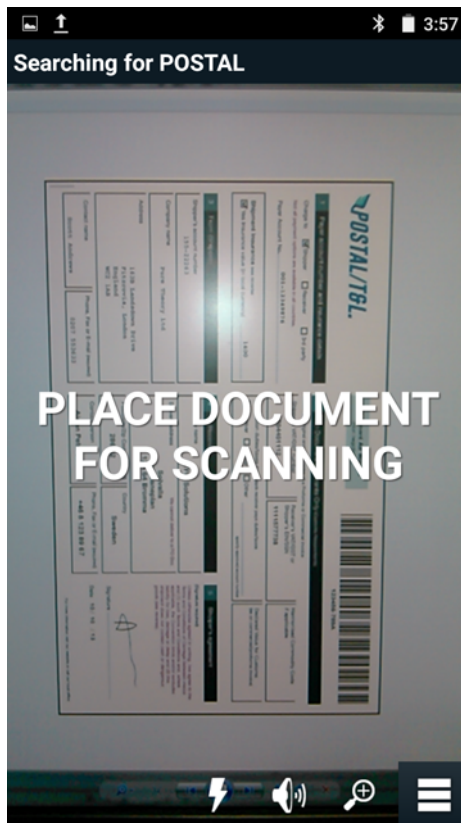

Figure 4-26 *Image Controls*

7. Position the camera over the form. Ensure that the complete border of the form is visible on the screen.
8. Hold the device steady.
9. Once the device detects the form **Tap Screen to Scan** appears on the screen.
10. Tap the screen to start the data capture. When completed, the device beeps and the data from the form displays.

Field	Parsed Data
Barcode	123456-789A
Charge To	<input checked="" type="checkbox"/>
Account Number	
Shipper Name	<div style="background-color: red; color: white; padding: 2px;">▲ Check Result</div> Pure Theory Ltd
Shipper Address	<div style="background-color: red; color: white; padding: 2px;">▲ Check Result</div> 1631 LaDWS@Bwn Drive Fitzrovia, London

RESCAN ACCEPT

Figure 4-27 Postal Data Screen

11. Touch the text boxes to correct any errors. Note: if there are too many errors, touch **Rescan** to perform the capture again.
12. Touch **Accept** to confirm the data is correct. The **Results summary** screen appears.
13. Touch **OK**.

Manufacturing Example

The Postal, Transportation and Logistics example uses the following form:.

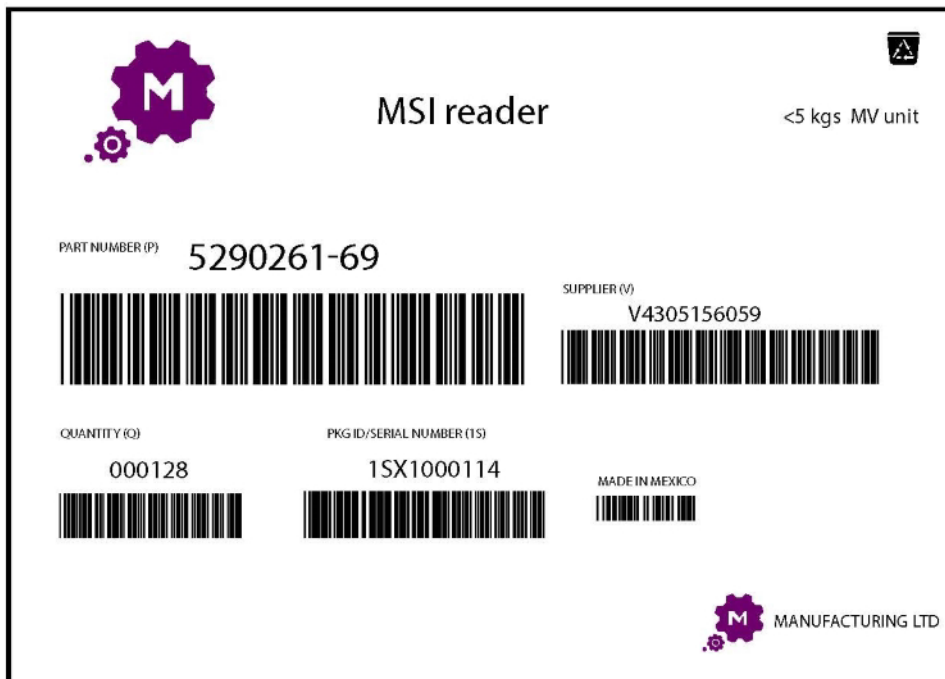

The image shows a manufacturing form for an MSI reader. At the top left is a purple gear logo with a white 'M'. To the right of the logo, the text 'MSI reader' is centered, and '<5 kgs MV unit' is on the far right. Below the logo, the form contains several fields with labels and values, each accompanied by a barcode:

- PART NUMBER (P):** 5290261-69
- SUPPLIER (V):** V4305156059
- QUANTITY (Q):** 000128
- PKG ID/SERIAL NUMBER (IS):** 1SX1000114
- MADE IN MEXICO:** (indicated by a small barcode)

At the bottom right, there is a purple gear logo with a white 'M' and the text 'MANUFACTURING LTD'.

Figure 4-28 *Manufacturing Form*

1. Copy the sample form from the device to a computer. See
2. Print this form.
3. Place the form on a flat surface.
4. On the device, launch **SimulScan Demo** application.
5. Touch the **Menu** icon in the top right corner of the screen.
6. Touch **Manufacturing**.
7. Touch **Start SimulScan**.
8. Point the top of the device at the document and center the target on the document.
9. Hold the device steady.
10. The device starts the data capture. When completed, the device beeps and the data from the document displays.

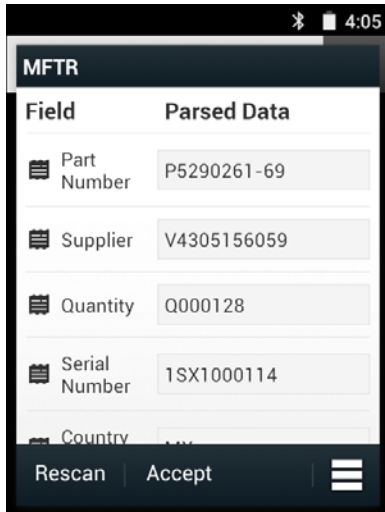

Figure 4-29 *Manufacturing Data*

11. Touch the text boxes to correct any errors. If there are too many errors, touch **Rescan** to perform the capture again.
12. Touch **Accept** to confirm the data is correct. The **Results summary** screen appears.
13. Touch **OK**.

Settings

To set the settings for the **SimulScan Demo** application touch **Menu** icon > **Settings**.

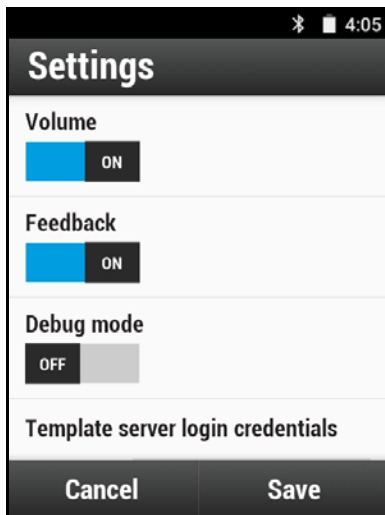



Figure 4-30 *Settings Screen*

- **Volume** - Toggle switch to turn audible notification on and off.
- **Haptic** - Toggle switch to turn vibration notification on and off.
- **Debug mode** - Toggle switch to enable or disable debug mode.
- **Template server login credentials** - enter credentials for accessing the template server.

Advanced Settings

Use the Advanced setting to configure data capture options. In the data capture screen, touch  in the bottom right corner of the screen.

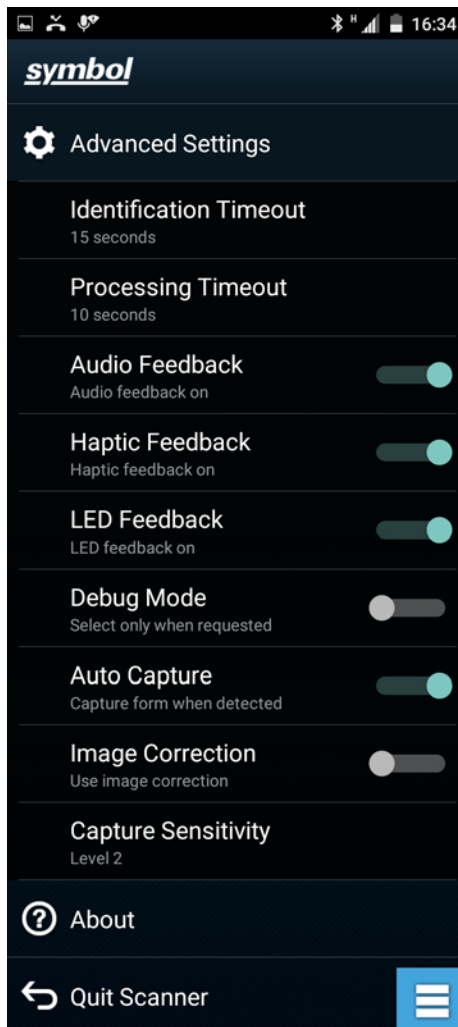

Figure 4-31 Advanced Settings Screen

- **Identification Timeout** - Set the amount of time to wait before timing out identifying the target document. Options: **2 seconds**, **5 seconds**, **10 seconds**, **15 seconds**, **20 seconds** or **25 seconds**.
- **Processing Timeout** - Once the target document is identified, amount of time to wait before timing out processing.
- **Audio Feedback** - Turn on or off audio feedback on successful parse.
- **Haptic Feedback** - Turn on or off haptic (vibration) feedback on successful parse.
- **LED Feedback** - Turn on or off LED feedback on successful parse.
- **Debug Mode** - If enabled, allows a session to write form capture, region images, region values, and other data to storage. Use only when directed by administrator.
- **Auto Capture** - Set to **On** to automatically capture forms when detected. Set to **Off** to manually capture forms when user taps screen or presses a trigger button.
- **Image Correction** - Turn on when document is crumpled or curved and requires advanced image correction.

- **Capture Sensitivity** - Increase sensitivity for increased document identification accuracy before processing.
- **About** - Displays the SimulScan Engine version number.
- **Quit Scanner** - Exit Advanced Settings screen.

Demo Customization

Before creating a customized demo, first:

- Create a template using the Template Builder tool.
 - Copy a company logo and image to the device storage location.
1. Touch **Menu** icon.
 2. Touch **Setup Custom Demo**.

The screenshot shows a mobile application screen titled "Title". It contains the following elements:

- Name:** A text input field containing "Custom Demo".
- Custom Demo Setup:** A text input field containing "Custom Demo".
- Image:** A text input field containing "Image.jpg".
- Logo:** A text input field containing "Logo.jpg".
- Introduction:** A text area containing the text: "Whether capturing multiple barcodes, delivery sheets, distribution manifests or inventory tables, SimulScan Document Capture saves you hours."
- Header Color:** A text input field.
- Icon color:** A text input field.
- Buttons:** "Cancel" and "Done" buttons at the bottom.

Figure 4-32 Custom Demo Setup Screen

3. In the **Name** text box, enter a name for the custom demo. This name appears in the drop-down menu.
4. In the **Custom Demo Setup** text box, enter a title for the demo. This appears in the demo screen title box.
5. Touch the **Image** field to select an image from the SD card.
6. Touch the **Logo** field to select the logo image from the SD card.
7. In the **Introduction** text box, enter text that will appear on the demo screen.
8. In the **Header color** text box, enter the hex color value for the header.
9. In the **Icon color** text box, enter the hex color value for Menu icon and button text.
10. In the **Key Features** text box, enter text that will appear under the Key Feature heading. This text appears in bullet format.

11. Touch one of the **SimulScan Document Capture Template** fields to select a template
 - a. **Browse external storage** - select a template loaded on the device.
 - b. **Default templates** - select one of the default templates.
 - c. **Select from server** - select a template from the SimulScan server.
12. Touch **Done**. The customized example appears on the screen.
13. Touch **Start SimulScan** to begin the demonstration.

Default Templates

The following templates are available:

- **Default - BankCheck.xml** – Use this template to read the MICR E-13B font (length between 19 and 40 characters) on bank checks.
- **Default - Barcode 1.xml** – Use this template to read a single supported bar code.
- **Default - Barcode 10.xml** – Use this template to read up to 10 supported bar codes.
- **Default - Barcode 2.xml** – Use this template to read two supported bar codes.
- **Default - Barcode 4.xml** – Use this template to read up to supported four bar codes.
- **Default - Barcode 5.xml** – Use this template to read up to supported five bar codes.
- **Default - BookNumber.xml** – Use this template to read the OCR-B ISBN 10 or 13 digit book numbers.
- **Default - DocCap + Optional Barcode** – Use this template to capture a full page image and decode any supported bar codes that are in the form. The captured area is the largest rectangular region in the field of view defined by the solid border or contrast of background. Any OCR or OMR content will not be decoded in this mode. The captured area is further processed to correct, de-skew and sharpen and returned as a picture.
- **Default - DocCap + Required Barcode** – Use this template to capture a full page image and decode of any supported bar codes that are present in the form. The captured area is the largest rectangular region in the field of view defined by the solid border or contrast of background. Any OCR or OMR content will not be decoded in this mode. The captured area is further processed to correct, de-skew and sharpen and returned as a picture.
- **Default - TravelDoc.xml** – Use this template to read passport and Visa travel documents with OCR-B types A and B fonts.
- **Default - Unstructured Multi-Line** – Use this template to read up to seven lines of text.
- **Default - Unstructured Single Line** – Use this template to read a single line of text.

RxLogger

RxLogger is a comprehensive diagnostic tool that provides application and system metrics. It allows for custom plug-ins to be created and work seamlessly with this tool. RxLogger is used to diagnose device and application issues. Its information tracking includes the following: CPU load, memory load, memory snapshots, battery consumption, power states, wireless logging, cellular logging, TCP dumps, Bluetooth logging, GPS logging, logcat, FTP push/pull, ANR dumps, etc. All logs and files generated are saved onto flash storage on the device (internal or external).

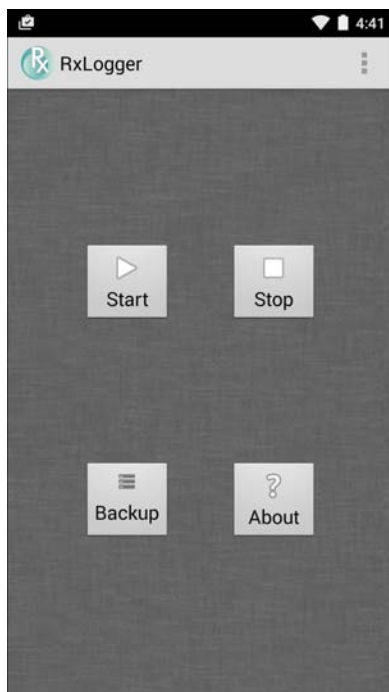

Figure 4-33 *RxLogger*

Elemesz



NOTE Elemesz collects specific device information in the background and sends this information to us to help improve product functionality. This feature can be disabled. See [Disabling Elemesz Data Collection on page 4-41](#).

Use **Elemesz** to provide diagnostics information to Zebra. Touch **Submit Diagnostics** button to send the data.

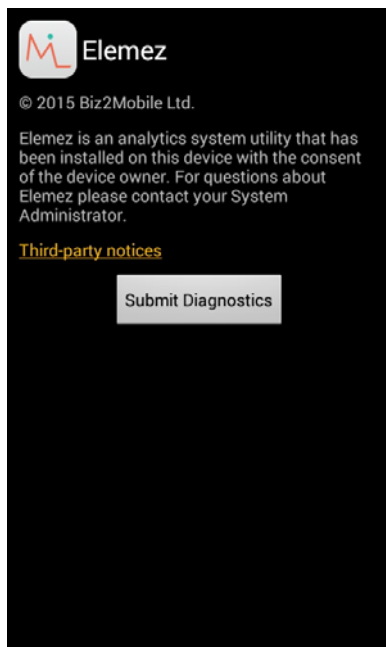

Figure 4-34 *Elemesz Application*





Disabling Elemesz Data Collection

The user can disable the **Elemesz** application from collection specific data in the background and sending it to Zebra Technologies.

1. From the Home screen, touch
2. Touch **Manage Apps**.
3. Swipe left or right until the **ALL** tab displays.
4. Scroll through the list and touch **Elemesz**.
5. In the **App info** screen, touch **Uninstall updates**.
6. In the **Uninstall updates** dialog box, touch **OK**.
7. Touch **OK**.
8. After uninstall is complete, touch **OK**.
9. In the **All** tab, scroll through the list and touch **Elemesz**.
10. Touch **Disable**.
11. In the **Disable built-in app?** dialog box, touch **OK**.
12. Touch

Enabling Elemetry Data Collection

The user can re-enable the Elemetry application for collection specific data in the background and sending it to Zebra Technologies.

1. From the Home screen, touch .
2. Touch **Manage Apps**.
3. Swipe left or right until the **ALL** tab displays.
4. Scroll through the list and touch **Elemetry**.
5. In the **App info** screen, touch **Enable**.
6. Touch .
7. Touch .
8. Touch .
9. Touch **Enable Elemetry**.

CHAPTER 5 DATA CAPTURE

Introduction

The TC75 offers data capture using the integrated imager, camera or the RS507 Hands-free imager.

Imaging

The TC75 with an integrated 2D imager has the following features:

- Omnidirectional reading of a variety of bar code symbologies, including the most popular linear, postal, PDF417, and 2D matrix code types.
- The ability to capture and download images to a host for a variety of imaging applications.
- Advanced intuitive laser aiming cross-hair and dot aiming for easy point-and-shoot operation.

The imager uses imaging technology to take a picture of a bar code, stores the resulting image in its memory, and executes state-of-the-art software decoding algorithms to extract the bar code data from the image.

Operational Modes

The TC75 with an integrated imager supports two modes of operation, listed below. Activate each mode by pressing the Scan button.

- **Decode Mode:** In this mode, the TC75 attempts to locate and decode enabled bar codes within its field of view. The imager remains in this mode as long as the user holds the scan button, or until it decodes a bar code.



NOTE To enable Pick List Mode, configure in DataWedge or set in an application using a API command.

- **Pick List Mode:** This mode allows the user to selectively decode a bar code when more than one bar code is in the TC75's field of view. To accomplish this, move the aiming crosshair or dot over the required bar code to decode only this bar code. This feature is ideal for pick lists containing multiple bar codes and manufacturing or transport labels containing more than one bar code type (either 1D or 2D).

Digital Camera

The device with an integrated camera based bar code scanning solution has the following features:

- Omnidirectional reading of a variety of bar code symbologies, including the most popular linear, postal, QR, PDF417, and 2D matrix code types.
- Cross-hair reticle for easy point-and-shoot operation.
- Picklist mode to decode a particular bar code from many in the field of view.

The solution uses the advanced camera technology to take a digital picture of a bar code, and executes state-of-the-art software decoding algorithms to extract the data from the image.

RS507 Hands-Free Imager

The RS507 Hands-free Imager is a wearable bar code scan solution for both 1D and 2D bar code symbologies. The scanner supports Bluetooth Human Interface Device (HID) connection to the device.

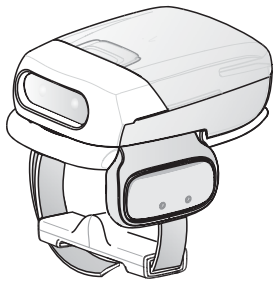

Figure 5-1 RS507 Hands-Free Imager

Refer to the *RS507 Hands-free Imager Product Reference Guide* for more information.

Scanning Considerations

Typically, scanning is a simple matter of aim, scan, and decode and a few quick trial efforts master it. However, consider the following to optimize scanning performance:

- **Range:** Any scanning device decodes well over a particular working range — minimum and maximum distances from the bar code. This range varies according to bar code density and scanning device optics. Scanning within range brings quick and constant decodes; scanning too close or too far away prevents decodes. Move the scanner closer and further away to find the right working range for the bar codes being scanned.
- **Angle:** Scanning angle is important for promoting quick decodes. When laser beams reflect directly back into the scanner from the bar code, this specular reflection can “blind” the scanner. To avoid this, scan the bar code so that the beam does not bounce directly back. But don’t scan at too sharp an angle; the scanner needs to collect scattered reflections from the scan to make a successful decode. Practice quickly shows what tolerances to work within.
- Hold the TC75 farther away for larger symbols
- Move the TC75 closer for symbols with bars that are close together.

- ✓ **NOTE** Scanning procedures depend on the application and TC75 configuration. An application may use different scanning procedures from the one listed above.

Imager Scanning

To read a bar code, a scan-enabled application is required. The TC75 contains the DataWedge application that allows the user to enable the imager, decode the bar code data and display the bar code content.

1. Ensure that an application is open on the TC75 and a text field is in focus (text cursor in text field).
2. Point the exit window on the top of the TC75 at a bar code.

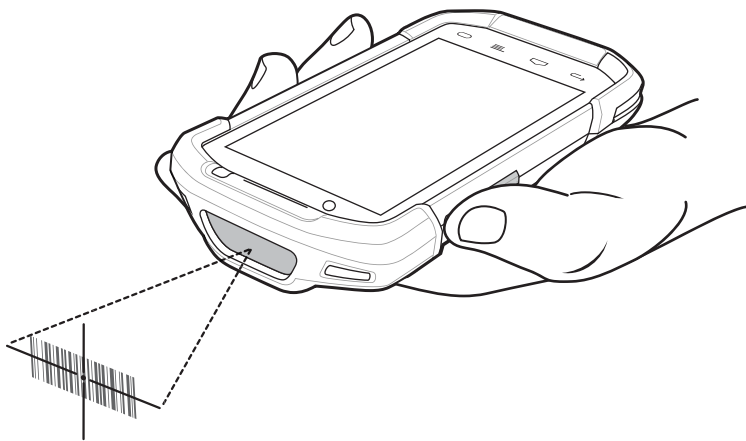

Figure 5-2 Imager Scanning

3. Press and hold the scan button.
The red laser aiming pattern turns on to assist in aiming.

- ✓ **NOTE** When the TC75 is in Picklist mode, the imager does not decode the bar code until the crosshair or aiming dot touches the bar code.

4. Ensure the bar code is within the area formed by the crosshairs in the aiming pattern. The aiming dot is used for increased visibility in bright lighting conditions.

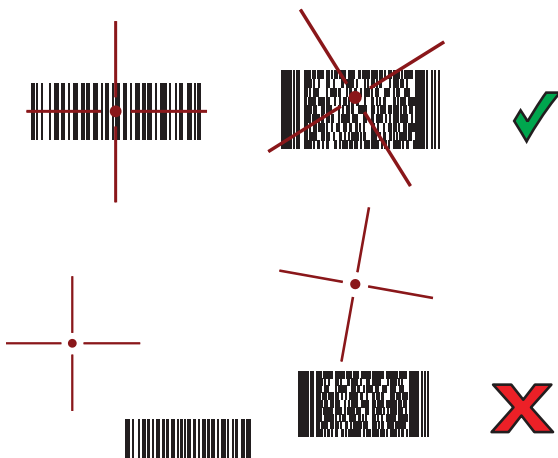

Figure 5-3 Aiming Pattern



Figure 5-4 *Pick List Mode with Multiple Bar Codes in Aiming Pattern*

5. The Data Capture LED lights green and a beep sounds, by default, to indicate the bar code was decoded successfully.
6. Release the scan button.

✓ **NOTE** Imager decoding usually occurs instantaneously. The TC75 repeats the steps required to take a digital picture (image) of a poor or difficult bar code as long as the scan button remains pressed.

7. The bar code content data displays in the text field.

Bar Code Capture with Integrated Camera

To capture bar code data:

✓ **NOTE** When capturing bar code data in poor lighting, turn on **Illumination mode** in the DataWedge application. See the *TC75 Integrator Guide* for detailed information on configuring DataWedge.

1. Ensure that an application is open on the device and a text field is in focus (text cursor in text field).
2. Aim the camera at a bar code.
3. Press and hold the Scan button. By default, a preview window appears on the screen. The Decode light emitting diode (LED) lights red to indicate that data capture is in process.

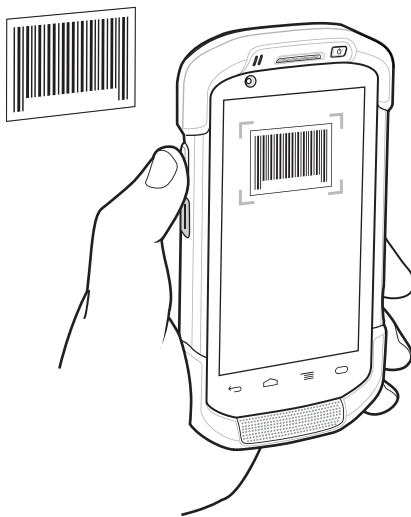

Figure 5-5 *Application with Preview Window*

✓ **NOTE** When Picklist mode is enabled, move the TC75 until the bar code is centered under the red target on the screen.

4. Move the TC75 until the bar code is visible on the screen.
5. The Decode LED lights green, a beep sounds and the device vibrates, by default, to indicate the bar code was decoded successfully.
6. The captured data appears in the text field.

Bar Code Capture with RS507 Hands-Free Imager

Pair the RS507 with the TC75. See [Pairing the RS507 Hands-Free Imager Using SSI on page 5-6](#) or [Pairing the RS507 Hands-Free Imager Bluetooth HID on page 5-7](#) for more information.

1. Ensure that an application is open on the device and a text field is in focus (text cursor in text field).
2. Point the RS507 at a bar code.

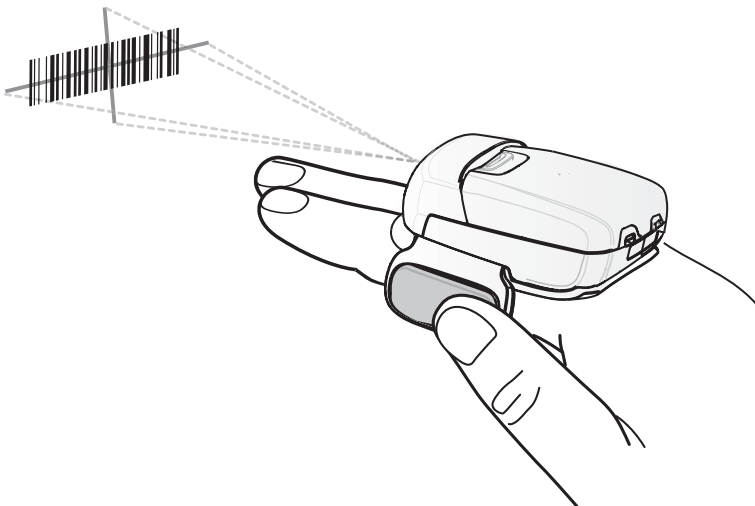

Figure 5-6 Bar Code Scanning with RS507

3. Press and hold the trigger.

The red laser aiming pattern turns on to assist in aiming. Ensure the bar code is within the area formed by the cross-hairs in the aiming pattern. The aiming dot is used for increased visibility in bright lighting conditions.

The RS507 LEDs light green, a beep sounds to indicate the bar code was decoded successfully. Note that when the RS507 is in Pick List Mode, the RS507 does not decode the bar code until the center of the crosshair touches the bar code.

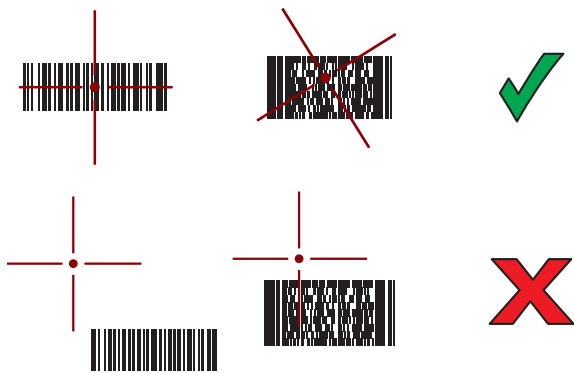

Figure 5-7 *Aiming Pattern*





Figure 5-8 *Pick List Mode with Multiple Bar Codes in Aiming Pattern*

4. The captured data appears in the text field.

Pairing the RS507 Hands-Free Imager Using SSI

An RS507 Hands-free Imager can be used with the device to capture bar code data.

1. Ensure that the two devices are within 10 meters (32.8 feet) of one another.
2. Install the battery into the RS507.
3. On the TC75, touch .
4. Touch .

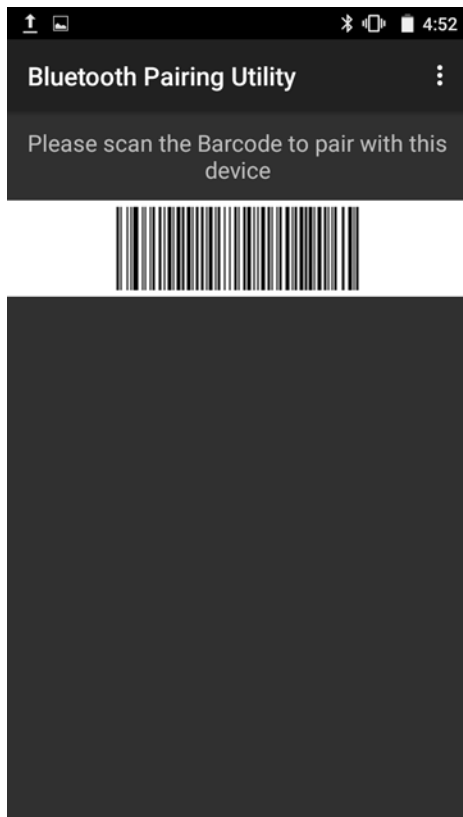

Figure 5-9 *Bluetooth Pairing Utility*

5. Using the RS507, scan the bar code on the screen.
The RS507 emits a high/low/high/low beeps. The Scan LED flashes green indicating that the RS507 is attempting to establish connection with the TC75. When connection is established, the Scan LED turns off and the RS507 emits one string of low/high beeps.
6. On the TC75, touch ↶.

Pairing the RS507 Hands-Free Imager Bluetooth HID

An RS507 Hands-free Imager can be used with the device to capture bar code data.

1. Ensure that Bluetooth is enabled on both devices.
2. Ensure that the Bluetooth device to discover is in discoverable mode.
3. Ensure that the two devices are within 10 meters (32.8 feet) of one another.
4. Place the RS507 in Human Interface Device (HID) mode. If the RS507 is already in HID mode, skip to step 5.
 - a. Remove the battery from the RS507.
 - b. Press and hold the Restore key.
 - c. Install the battery onto the RS507.
 - d. Keep holding the Restore key for about five seconds until a chirp is heard and the Scan LEDs flash green.
 - e. Scan the bar code below to place the RS507 in HID mode.



Figure 5-10 RS507 Bluetooth HID Bar Code

5. Remove the battery from the RS507.
6. Re-install the battery into the RS507.
7. On the TC75, touch
8. Touch
9. Touch **Bluetooth**.
10. Touch **SCAN FOR DEVICES**. The device begins searching for discoverable Bluetooth devices in the area and displays them under **AVAILABLE DEVICES**.
11. Scroll through the list and select RS507.

The device connects to the RS507 and **Connected** appears below the device name. The Bluetooth device is added to the **Bluetooth devices** list and a trusted ("paired") connection is established.

DataWedge

DataWedge is a utility that adds advanced bar code scanning capability to any application without writing code. It runs in the background and handles the interface to built-in bar code scanners. The captured bar code data is converted to keystrokes and sent to the target application as if it was typed on the keypad.

To configure DataWedge refer to the *TC75 Integrator Guide*.

Enabling DataWedge

1. Touch
2. Touch
3. Touch
4. Touch **Settings**.
5. Touch the **DataWedge enabled** checkbox. A blue checkmark appears in the checkbox indicating that DataWedge is enabled.
6. Touch

Disabling DataWedge

1. Touch
2. Touch
3. Touch
4. Touch **Settings**.
5. Touch the **DataWedge enabled** checkbox. The blue checkmark disappears from the checkbox indicating that DataWedge is disabled.
6. Touch

CHAPTER 6 WIRELESS

Introduction

This section provides information on the wireless features:

- Wireless Wide Area Network (WWAN)
- Wireless Local Area Network (WLAN)
- Bluetooth
- Near Field Communications (NFC).

Wireless Wide Area Networks

Use Wireless wide area networks (WWANs) to access data over a cellular network. This section provides information on:



- Setting default SIM slot
- Sharing a data connection
- Disabling data roaming
- Monitoring data usage
- Limiting connections to 2G networks
- Locking a SIM card
- Editing Access Point Names (APNs).

Sharing the Mobile Data Connection

The **tethering & portable hotspot** settings allow you to share your data connection. You can share the TC75's mobile data connection with a single computer via USB tethering or Bluetooth tethering. You can also share the data connection with up to eight devices at once, by turning it into a portable Wi-Fi hotspot. While the TC75 is sharing its data connection, an icon appears at the top of the screen and a corresponding message appears in the notification list.

USB Tethering

- ✓ **NOTE** USB tethering is not supported on computers running Mac OS. If your computer is running Windows 7 or a recent version of Linux (such as Ubuntu), follow these instructions without any special preparation. If running a version of Windows that precedes Windows 7, or some other operating system, you may need to prepare the computer to establish a network connection via USB.



1. Connect the TC75 to a host computer with the USB cable.
A USB icon appears at the top of the screen, and the notification **Connected as a media device** or **Connected as a camera** appears briefly at the top of the screen.
2. Touch  > .
3. Touch **...** **More**.
4. Touch **Tethering & portable hotspot**.
5. Check **USB tethering**.
The host computer is now sharing the TC75's data connection.

To stop sharing the data connection, uncheck **USB tethering** or disconnect the USB cable.

Bluetooth Tethering

Use Bluetooth tethering to share the data connection with a host computer.



Configure the host computer to obtain its network connection using Bluetooth. For more information, see the host computer's documentation.

1. Pair the TC75 with the host computer.
2. Touch  > .
3. Touch **...** **More**.
4. Touch **Tethering & portable hotspot**.
5. Check **Bluetooth tethering**.
The host computer is now sharing the TC75's data connection.

To stop sharing the data connection, uncheck **Bluetooth tethering**.



Portable Wi-Fi Hotspot

Configure the Wi-Fi Hotspot settings.

1. Touch  > .
2. Touch **...** **More**.
3. Touch **Tethering & portable hotspot**.
4. Check **Portable Wi-Fi hotspot**.
After a moment, the TC75 starts broadcasting its Wi-Fi network name (SSID), so you can connect to it with up to eight computers or other devices.

To stop sharing the data connection, uncheck **Portable Wi-Fi hotspot**.

Configuring the Wi-Fi Hotspot

1. Touch  > .
2. Touch **More**.
3. Touch **Tethering & portable hotspot**.

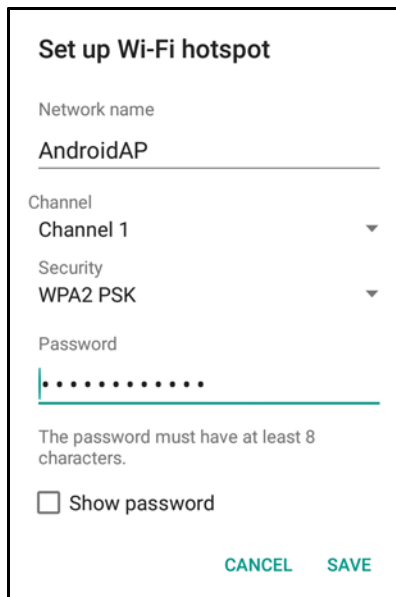

Figure 6-1 *Set up Wi-Fi Hotspot Dialog Box*



4. Touch **Set up Wi-Fi hotspot**.
5. In the **Network name** text field, edit the network name.
6. Touch the **Channel** option and select a channel number from the drop-down list.
7. Touch the **Security** option and select a security method from the drop-down list.
 - **None**
 - **WPA2 PSK**
8. In the **Password** text field, enter a password.

✓ **NOTE** If **None** is selected in the **Security** option, a password is not required.

9. Touch **Save**.

Data Usage

Data usage refers to the amount of data uploaded or downloaded by the TC75 during a given period. Depending on the wireless plan, you may be charged additional fees when your data usage exceeds your plan's limit. To

monitor your data usage, go to  >  **Data usage**.



CAUTION The usage displayed on the data usage settings screen is measured by your device. Your carrier's data usage accounting may differ. Usage in excess of your carrier plan's data limits can result in steep overage charges. The feature described here can help you track your usage, but is not guaranteed to prevent additional charges.

Data usage settings allow you to:

- Set the data usage level at which you'll receive a warning.
- Set a data usage limit.
- View or restrict data usage by app.
- Identify mobile hotspots and restrict background downloads that may result in extra charges.

By default, when you open the data usage settings screen you see the settings for mobile data: that is, the data network or networks provided by your carrier:

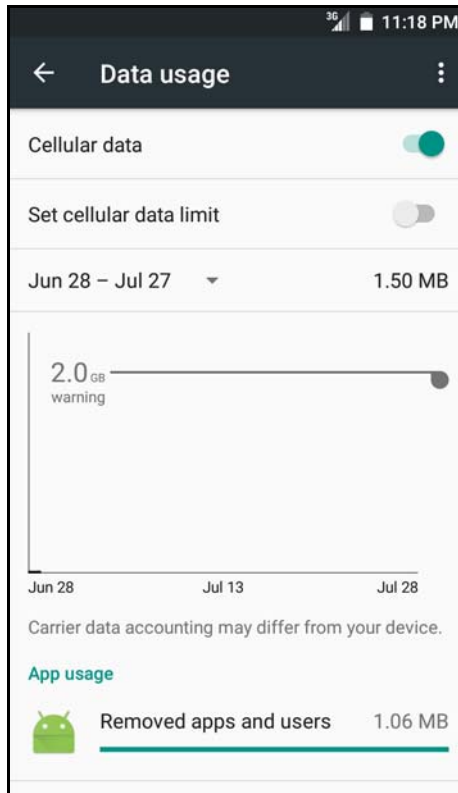

Figure 6-2 *Data Usage Screen*

To display Wi-Fi data usage settings in a separate tab touch **⋮** > **Show Wi-Fi**.

Just below the on-off switch, note the data usage cycle. Touch it to choose a different cycle. This date range is the period of time for which the graph displays data usage.

The vertical white lines on the graph show a period of time within the data usage cycle. This range determines the usage amount displayed just below the graph. Drag lines to change the period.

Set Data Usage Warning

Drag the orange line by its right side to the level where you want to receive a warning. When your data usage reaches this level, you'll receive a notification.



Set Auto-Sync

You can also conserve data usage by syncing your apps manually, only when you need the data, rather than relying on auto-sync.

To turn auto-sync off or on, touch  > **Accounts** >  > **Auto-sync data**.



Disabling Data When Roaming

To prevent the device from transmitting data over other carriers' mobile networks when leaving an area that is covered by the carrier's networks. This is useful for controlling expenses if the service plan does not include data roaming.

1. Touch  > .
2. Touch  **More**.
3. Touch **Cellular networks**.
4. Un-check **Data roaming**.



Limiting Data Connection to 2G Networks

Extend the battery life by limiting the data connections to 2G networks (GPRS or EDGE). When connected to a 2G network, the user may want to postpone activities that transmit a lot of data, such as sending, uploading, or downloading pictures or video, until they are connected to a faster mobile or other wireless network.

1. Touch  > .
2. Touch  **More**.
3. Touch **Cellular networks**.
4. Touch **GSM 2G/3G selection**.
5. Touch **2G only**.

Locking the SIM Card

Locking the SIM card requires the user to enter a PIN every time the device is turned on. If the correct PIN is not entered, only Emergency calls can be made.

1. Touch  > .
2. Touch  **Security**.
3. Touch **Set up SIM/RUIM card lock**.
4. Touch **Lock SIM card**.

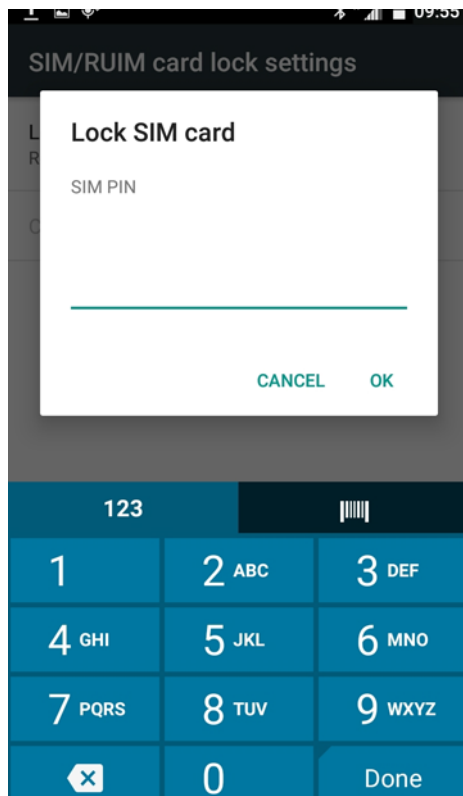







Figure 6-3 Enter PIN to Lock SIM Card

5. Enter the PIN associated with the card. Touch **OK**.
6. Reset the device.

Editing the Access Point Name

- ✓ **NOTE** Many service provider Access Point Name (APN) data are pre-configured in the device. The APN information for all other service providers must be obtained from the wireless service provider.

To use the data on a network the user must configure the APN information.

1. Touch  > .
2. Touch  **More**.
3. Touch **Cellular networks**.
4. Touch **Access Point Names**.
5. Touch an APN name in the list to edit an existing APN or touch  to create a new APN.
6. Touch each APN settings and enter the appropriate data obtained from the wireless service provider.
7. When finished, touch .
8. Touch **Save**.
9. Touch the radio button next to the new APN name to start using it.
10. Touch .

Wireless Local Area Networks

Wireless local area networks (WLANs) allow the TC75 to communicate wirelessly inside a building. Before using the TC75 on a WLAN, the facility must be set up with the required hardware to run the WLAN (sometimes known as infrastructure). The infrastructure and the TC75 must both be properly configured to enable this communication.

Refer to the documentation provided with the infrastructure (access points (APs), access ports, switches, Radius servers, etc.) for instructions on how to set up the infrastructure.

Once the infrastructure is set up to enforce the chosen WLAN security scheme, use the **Wireless & networks** settings to configure the TC75 to match the security scheme.

The TC75 supports the following WLAN security options:

- Open
- Wireless Equivalent Privacy (WEP).
- Wi-Fi Protected Access (WPA)/WPA2 Personal (PSK).
- Extensible Authentication Protocol (EAP).

The **Status** bar displays icons that indicate Wi-Fi network availability and Wi-Fi status. See Status Bar for more information.



NOTE Turn off Wi-Fi when not using it, to extend the life of the battery.

Scan and Connect to a Wi-Fi Network

1. Touch  > .
2. Touch  **Wi-Fi**.

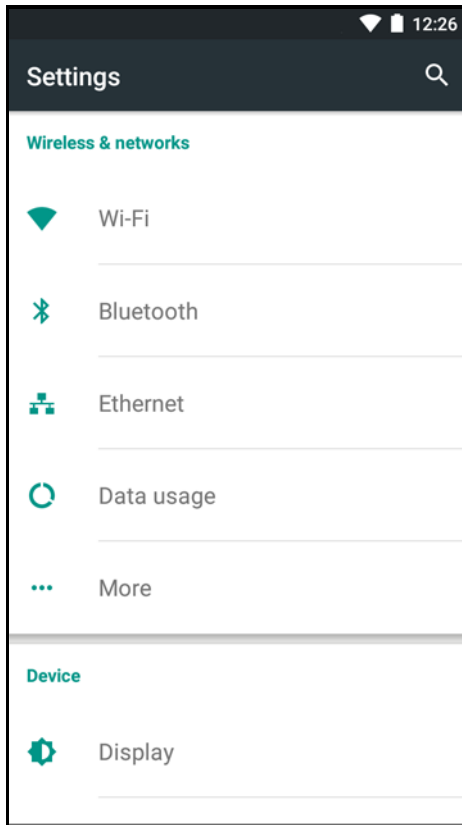

Figure 6-4 *Settings Screen*

3. Slide the **Wi-Fi** switch to the **ON** position. The TC75 searches for WLANs in the area and lists them.

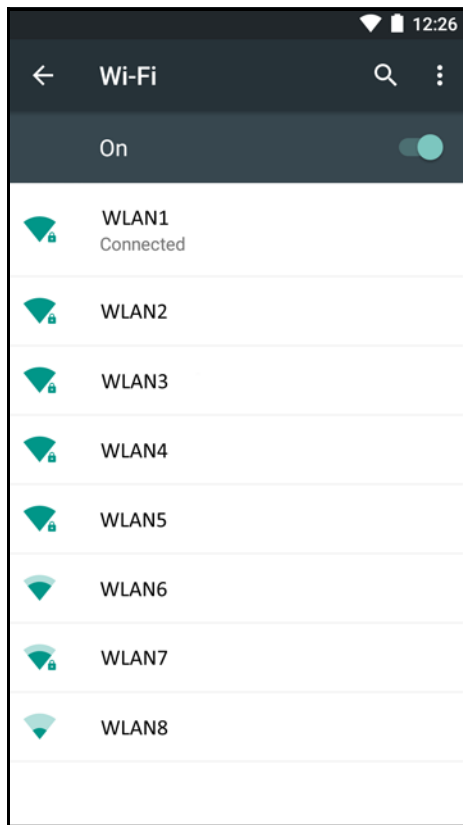

Figure 6-5 *Wi-Fi Screen*



4. Scroll through the list and select the desired WLAN network.
5. For open networks, touch profile once or press and hold and then select **Connect to network** or for secure networks enter the required password or other credentials then touch **Connect**. See the system administrator for more information.

The TC75 obtains a network address and other required information from the network using the dynamic host configuration protocol (DHCP) protocol. To configure the TC75 with a fixed internet protocol (IP) address, See [Configuring the Device to Use a Static IP Address on page 6-12](#).

6. In the Wi-Fi setting field, **Connected** appears indicating that the TC75 is connected to the WLAN.

Configuring a Wi-Fi Network

To set up a Wi-Fi network:

1. Touch  > .
2. Touch  **Wi-Fi**.
3. Slide the switch to the **ON** position.
4. The device searches for WLANs in the area and lists them on the screen.
5. Scroll through the list and select the desired WLAN network.
6. Touch the desired network. If the network security is **Open**, the device automatically connects to the network. For all other network security a dialog box appears.

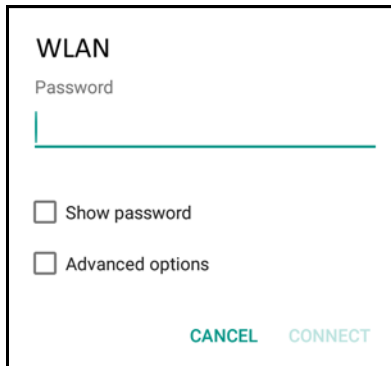

WLAN

Password

Show password

Advanced options

CANCEL **CONNECT**

Figure 6-6 WLAN Network Security Dialog Box

7. If the network security is **WEP** or **WPA/WPS2 PSK**, enter the required password and then touch **Connect**.

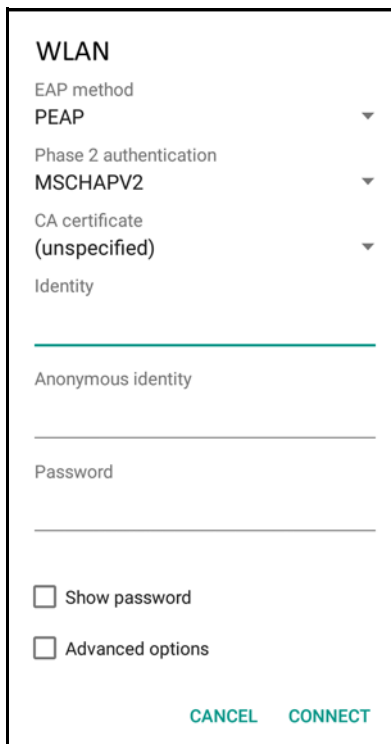

WLAN

EAP method
PEAP ▾

Phase 2 authentication
MSCHAPV2 ▾

CA certificate
(unspecified) ▾

Identity

Anonymous identity

Password

Show password

Advanced options

CANCEL **CONNECT**

Figure 6-7 802.1x EAP Security Dialog Box

8. If the network security is 802.1x EAP:
- Touch the EAP method drop-down list and select **PEAP**, **TLS**, **TTLS**, **LEAP** or **FAST**.
 - Touch the **Phase 2 authentication** drop-down list and select an authentication method.
 - If required, touch **CA certificate** and select a Certification Authority (CA) certificate. Note: Certificates are installed using the **Security** settings.
 - If required, touch **User certificate** and select a user certificate. Note: User certificates are installed using the Location & security settings.
 - If required, in the **Identity** text box, enter the username credentials.
 - If desired, in the **Anonymous identity** text box, enter an anonymous identity username.

- If required, in the **Password** text box, enter the password for then given identity.





✓ **NOTE** By default, the network Proxy is set to **None** and the IP settings is set to **DHCP**. See [Configuring for a Proxy Server on page 6-12](#) for setting connection to a proxy server and see [Configuring the Device to Use a Static IP Address on page 6-12](#) for setting the device to use a static IP address.

9. Touch **Connect**.

10. Touch .

Manually Adding a Wi-Fi Network

Manually add a Wi-Fi network if the network does not broadcast its name (SSID) or to add a Wi-Fi network when out of range.

1. Touch  > .
2. Touch  **Wi-Fi**.
3. Slide the Wi-Fi switch to the **On** position.
4. Touch  > **Add network**.
5. In the **Network name** text box, enter the name of the Wi-Fi network.
6. In the **Security** drop-down list, select the type of security. Options:
 - **None**
 - **WEP**
 - **WPA/WPA2 PSK**
 - **802.1x EAP**.
7. If the network security is **None**, touch **Save**.
8. If the network security is **WEP** or **WPA/WPA2 PSK**, enter the required password and then touch **Save**.
9. If the network security is **802.1x EAP**:
 - Touch the **EAP method** drop-down list and select **PEAP**, **TLS**, **TTLS**, **LEAP** or **FAST**.
 - Touch the **Phase 2 authentication** drop-down list and select an authentication method.
 - If required, touch **CA certificate** and select a Certification Authority (CA) certificate. Note: Certificates are installed using the **Security** settings.
 - If required, touch **User certificate** and select a user certificate. Note: User certificates are installed using the **Security** settings.
 - If required, in the **Identity** text box, enter the username credentials.
 - If desired, in the **Anonymous** identity text box, enter an anonymous identity username.
 - If required, in the **Password** text box, enter the password for then given identity.

✓ **NOTE** By default, the network Proxy is set to **None** and the IP settings is set to **DHCP**. See [Configuring for a Proxy Server on page 6-12](#) for setting connection to a proxy server and see [Configuring the Device to Use a Static IP Address on page 6-12](#) for setting the device to use a static IP address.

10. Touch **Save**. To connect to the saved network, touch the saved network and select **CONNECT**.

11. Touch .

Configuring for a Proxy Server

A proxy server is a server that acts as an intermediary for requests from clients seeking resources from other servers. A client connects to the proxy server, requesting some service, such as a file, connection, web page, or other resource, available from a different server. The proxy server evaluates the request according to its filtering rules. For example, it may filter traffic by IP address or protocol. If the request is validated by the filter, the proxy provides the resource by connecting to the relevant server and requesting the service on behalf of the client.

It is important for enterprise customers to be able to set up secure computing environments within their companies, and proxy configuration is an essential part of doing that. Proxy configuration acts as a security barrier ensuring that the proxy server monitors all traffic between the Internet and the intranet. This is normally an integral part of security enforcement in corporate firewalls within intranets.

1. In the network dialog box, touch a network.
2. Touch **Advanced options** checkbox.
3. Touch **Proxy settings** and select **Manual**.

Proxy
Manual

The HTTP proxy is used by the browser but may not be used by the other apps.

Proxy hostname
proxy.example.com

Proxy port
8080

Bypass proxy for
example.com,mycomp.test.com,

Figure 6-8 Proxy Settings

4. In the **Proxy hostname** text box, enter the address of the proxy server.
5. In the **Proxy port** text box, enter the port number for the proxy server.
6. In the **Bypass proxy for** text box, enter addresses for web sites that do not require to go through the proxy server. Use a comma “,” between addresses.

When entering proxy addresses the **Bypass proxy for** field, do not use spaces or carriage returns between addresses.

7. Touch **Connect**.
8. Touch .

Configuring the Device to Use a Static IP Address

By default, the device is configured to use Dynamic Host Configuration Protocol (DHCP) to assign an Internet protocol (IP) address when connecting to a wireless network. To configure the device to connect to a network using a static IP address:

1. In the **Wi-Fi** list, touch a network.
2. Touch **Advanced options** checkbox.
3. Touch **IP settings** and select **Static**.

IP settings
Static ▼
 IP address
 192.168.1.128
 Gateway
 192.168.1.1
 Network prefix length
 24
 DNS 1
 8.8.8.8
 DNS 2
 8.8.4.4

Figure 6-9 *Static IP Settings*

4. In the **IP address** text box, enter an IP address for the device.
5. If required, in the **Gateway** text box, enter a gateway address for the device.
6. If required, in the **Network prefix length** text box, enter a the prefix length.
7. If required, in the **DNS 1** text box, enter a Domain Name System (DNS) address.
8. If required, in the **DNS 2** text box, enter a DNS address.
9. Touch **Connect**.
10. Touch .

Advanced Wi-Fi Settings

✓ **NOTE** Advanced Wi-Fi settings are for the device not for a specific wireless network.

Use the **Advanced** settings to configure advanced Wi-Fi settings. From the **Wi-Fi** screen, touch  > **Advanced** to view the advanced settings.

- **Network notification** - When enabled, notifies the user when an open network is available.
- **Scanning always available** - Select to let Google's location service and other applications scan for networks, even when Wi-Fi is off. (default - disabled).
- **Keep Wi-Fi on during sleep** - Opens a menu to set whether and when the Wi-Fi radio turns off.
 - **Always On** - The radio stays on when the device enters suspend mode (default).
 - **Only when plugged in** - The radio stays on while the device is connected to external power.
 - **Never On** - The radio turns off when the device enters suspend mode (default).
- **Wi-Fi frequency band** - Options: Automatic (default), 5 GHz only or 2.4 GHz only.
- **Install Certificates** – Touch to install certificates.
- **Wi-Fi Direct** - Displays a list of devices available for a direct Wi-Fi connection.
- **WPS Push Button** - Touch to connect to a network using Wi-Fi Protected Setup (WPS) push button method.

- **WPS Pin Entry**- Touch to connect to a network using Wi-Fi Protected Setup (WPS) pin entry method.
- **MAC address** - Displays the Media Access Control (MAC) address of the device when connecting to Wi-Fi networks.
- **IP address** - Displays the IP address of the device.

Additional Settings

Use the **Additional settings** to configure advanced Wi-Fi settings. From the **Wi-Fi** screen, touch **⋮** > **Advanced** to view the advanced settings.

- Regulatory
 - **Country selection** - Displays the acquired country code if 802.11d is enabled else it displays the currently selected country code.
 - **Region code** - Displays the current region code.
- Band and Channel Selection
 - **Wi-Fi frequency band** - Use to select the frequency band. Options: **Auto** (default), **5 GHz only** or **2.4 GHz only**.
 - **Available channels (2.4 GHz)** - Use to select specific channels. Touch to display the **Available channels** menu. Select specific channels. Touch **OK**.
 - **Available channels (5 GHz)** - Use to select specific channels. Touch to display the **Available channels** menu. Select specific channels. Touch **OK**.
- Logging
 - **Advanced Logging** – Touch to enable advanced logging. Advanced logging
 - **Wireless logs** - Use to capture Wi-Fi log files.
 - **Fusion Logger** - Touch to open the **Fusion Logger** application. This application maintains a history of high level WLAN events which helps to understand the status of connectivity.



Figure 6-10 Fusion Logger Screen

- **Fusion Status** - Touch to display live status of WLAN state. Also provides information of device and connected profile.

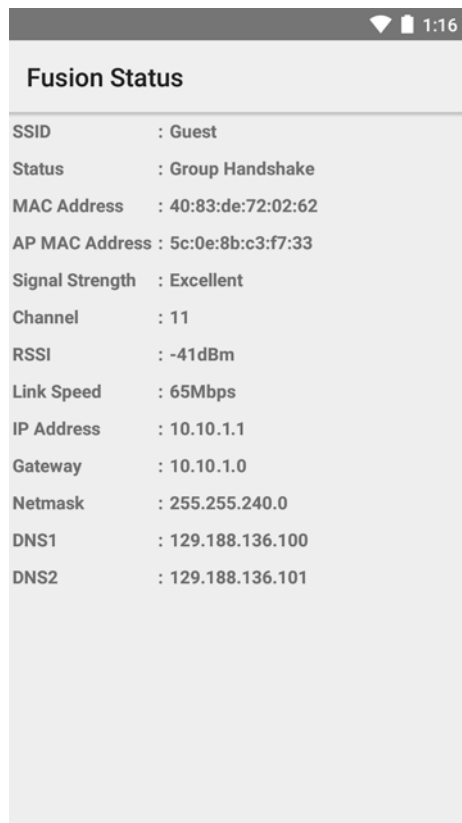





Figure 6-11 Fusion Status Screen

- About
 - **Version** - Displays the current Fusion information.

Remove a Wi-Fi Network

To remove a remembered or connected network:

1. Touch  > .
2. Touch  **Wi-Fi**.
3. In the **Wi-Fi networks** list, touch and hold the name of the network.
4. In the menu, touch **Forget network**.
5. Touch .

Bluetooth

Bluetooth-equipped devices can communicate without wires, using frequency-hopping spread spectrum (FHSS) radio frequency (RF) to transmit and receive data in the 2.4 GHz Industry Scientific and Medical (ISM) band (802.15.1). Bluetooth wireless technology is specifically designed for short-range (10 meters (32.8 feet)) communication and low power consumption.

Devices with Bluetooth capabilities can exchange information (e.g., files, appointments, and tasks) with other Bluetooth enabled devices such as printers, access points, and other mobile devices.

The TC75 support Bluetooth Low Energy. Bluetooth Low Energy is targeted at applications in the healthcare, fitness, security, and home entertainment industries. It provides reduced power consumption and cost while maintaining standard Bluetooth range.

Adaptive Frequency Hopping

Adaptive Frequency Hopping (AFH) is a method of avoiding fixed frequency interferers, and can be used with Bluetooth voice. All devices in the piconet (Bluetooth network) must be AFH-capable in order for AFH to work. There is no AFH when connecting and discovering devices. Avoid making Bluetooth connections and discoveries during critical 802.11b communications. AFH for Bluetooth consists of four main sections:

- Channel Classification - A method of detecting an interference on a channel-by-channel basis, or pre-defined channel mask.
- Link Management - Coordinates and distributes the AFH information to the rest of the Bluetooth network.
- Hop Sequence Modification - Avoids interference by selectively reducing the number of hopping channels.
- Channel Maintenance - A method for periodically re-evaluating the channels.

When AFH is enabled, the Bluetooth radio “hops around” (instead of through) the 802.11b high-rate channels. AFH coexistence allows Enterprise devices to operate in any infrastructure.

The Bluetooth radio in this device operates as a Class 2 device power class. The maximum output power is 2.5 mW and the expected range is 10 meters (32.8 ft.). A definition of ranges based on power class is difficult to obtain due to power and device differences, and whether one measures open space or closed office space.



NOTE It is not recommended to perform Bluetooth wireless technology inquiry when high rate 802.11b operation is required.

Security

The current Bluetooth specification defines security at the link level. Application-level security is not specified. This allows application developers to define security mechanisms tailored to their specific need. Link-level security occurs between devices, not users, while application-level security can be implemented on a per-user basis. The Bluetooth specification defines security algorithms and procedures required to authenticate devices, and if needed, encrypt the data flowing on the link between the devices. Device authentication is a mandatory feature of Bluetooth while link encryption is optional.

Pairing of Bluetooth devices is accomplished by creating an initialization key used to authenticate the devices and create a link key for them. Entering a common personal identification number (PIN) in the devices being paired generates the initialization key. The PIN is never sent over the air. By default, the Bluetooth stack responds with no key when a key is requested (it is up to user to respond to the key request event). Authentication of Bluetooth devices is based-upon a challenge-response transaction. Bluetooth allows for a PIN or passkey used to create other 128-bit keys used for security and encryption. The encryption key is derived from the link key used to authenticate the pairing devices. Also worthy of note is the limited range and fast frequency hopping of the Bluetooth radios that makes long-distance eavesdropping difficult.

Recommendations are:

- Perform pairing in a secure environment
- Keep PIN codes private and do not store the PIN codes in the device
- Implement application-level security.

Bluetooth Profiles

The device supports the following Bluetooth services:

- Service Discovery Protocol (SDP) - Handles the search for known and specific services as well as general services.
- Serial Port Profile (SPP) - Allows use of RFCOMM protocol to emulate serial cable connection between two Bluetooth peer devices. For example, connecting the device to a printer.
- Object Push Profile (OPP) - Allows the device to push and pull objects to and from a push server.
- Advanced Audio Distribution Profile (A2DP) - Allows the device to stream stereo-quality audio to a wireless headset or wireless stereo speakers.
- Audio/Video Remote Control Profile (AVRCP) - Allows the device to control A/V equipment to which a user has access. It may be used in concert with A2DP.
- Personal Area Network (PAN) - Allows the use of Bluetooth Network Encapsulation Protocol to provide L3 networking capabilities over a Bluetooth link. PANU and NAP roles are supported.
- Human Interface Device Profile (HID) - Allows Bluetooth keyboards, pointing devices, gaming devices and remote monitoring devices to connect to the device.
- Headset Profile (HSP) - Allows a hands-free device, such as a Bluetooth headset, to place and receive calls on the device.
- Hands-Free Profile (HFP) - Allows car hands-free kits to communicate with the device in the car.
- Out of Band (OOB) - Allows exchange of information used in the pairing process. Pairing is completed using the Bluetooth radio, but requires information from the OOB mechanism. Using OOB with NFC enables pairing when devices simply get close, rather than requiring a lengthy discovery process.

Bluetooth Power States

The Bluetooth radio is off by default.

- **Suspend** - When the TC75 goes into suspend mode, the Bluetooth radio stays on.
- **Airplane Mode** - When the TC75 is placed in Airplane Mode, the Bluetooth radio turns off. When Airplane mode is disabled, the Bluetooth radio returns to the prior state. When in Airplane Mode, the Bluetooth radio can be turned back on if desired.

Bluetooth Radio Power

Turn off the Bluetooth radio to save power or if entering an area with radio restrictions (e.g., an airplane). When the radio is off, other Bluetooth devices cannot see or connect to the device. Turn on the Bluetooth radio to exchange information with other Bluetooth devices (within range). Communicate only with Bluetooth radios in close proximity.







NOTE To achieve the best battery life turn off radios when not in use.

Enabling Bluetooth

1. Touch  > .
2. Touch  **Bluetooth**.
3. Slide the Bluetooth switch to the **ON** position.  also appears in the Status bar.



4. Touch .

Disabling Bluetooth

1. Touch  > .
2. Touch  **Bluetooth**.
3. Slide the Bluetooth switch to the **OFF** position.
4. Touch .

Discovering Bluetooth Device(s)

The TC75 can receive information from discovered devices without pairing. However, once paired, the TC75 and a paired device exchange information automatically when the Bluetooth radio is on. To find Bluetooth devices in the area:

1. Ensure that Bluetooth is enabled on both devices.
2. Ensure that the Bluetooth device to discover is in discoverable mode.
3. Ensure that the two devices are within 10 meters (32.8 feet) of one another.
4. Touch  > .
5. Touch  **Bluetooth**.
6. The TC75 begins searching for discoverable Bluetooth devices in the area and displays them under **Available devices**.
7. Scroll through the list and select a device. The **Bluetooth pairing request** dialog box appears.

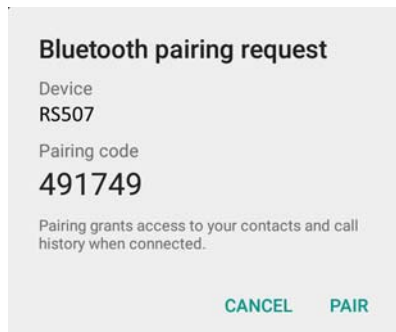







Figure 6-12 *Bluetooth Pairing*

8. Touch **Pair** on both devices.
9. The Bluetooth device is added to the **Bluetooth devices** list and a trusted (“paired”) connection is established.

Changing the Bluetooth Name



By default, the TC75 has a generic Bluetooth name that is visible to other devices when connected.

1. Touch  > .
2. Touch  **Bluetooth**.
3. If Bluetooth is not on, slide the switch to the **ON** position.

4. Touch  > **Rename device**.
5. Enter a name and touch **Done**.
6. Touch .

Connecting to a Bluetooth Device

Once paired, connect to a Bluetooth device.

1. Touch  > .
2. Touch  **Bluetooth**.
3. If Bluetooth is not on, slide the switch to the **ON** position.
4. In the **Paired devices** list, touch a unconnected Bluetooth device.
When connected, the device is displayed as connected in the list.





Selecting Profiles on the Bluetooth Device

Some Bluetooth devices have multiple profiles. To select a profile:

1. Touch  > .
2. Touch  **Bluetooth**.
3. In the **Paired devices** list, touch  next to the device name.
4. Under **Use for**, check or uncheck a profile to allow the device to use that profile.
5. Touch .

Unpairing a Bluetooth Device

To unpair a Bluetooth device and erase all pairing information:

1. Touch  > .
2. Touch  **Bluetooth**.
3. In the **Paired devices** list, touch  next to the device name.
4. Touch **FORGET**.
5. Touch .

Near Field Communications

NFC/HF RFID is a short-range wireless connectivity technology standard that enables secure transaction between a reader and a contactless smartcard. The technology is based on ISO/IEC 14443 type A and B (proximity) and ISO/IEC 15693 (vicinity) standards, using the HF 13.56 MHz unlicensed band. The TC75 support 3 operating modes:

- Reader mode

- Peer-to-Peer communication
- Card Emulation mode.

Using NFC, the TC75 can:

- Read contactless cards such as contactless tickets, ID cards and ePassport.
- Read and write information to contactless cards such as SmartPosters and tickets, as well as devices with NFC interface such as vending machines.
- Read information from supported medical sensors.
- Pair with supported Bluetooth devices such as printers and headsets.
- Exchange data with another NFC device.
- Emulate contactless card such as payment, ticket or SmartPoster.

The TC75 NFC antenna is uniquely positioned to read NFC cards from the top of the device while being held in the user's hand.

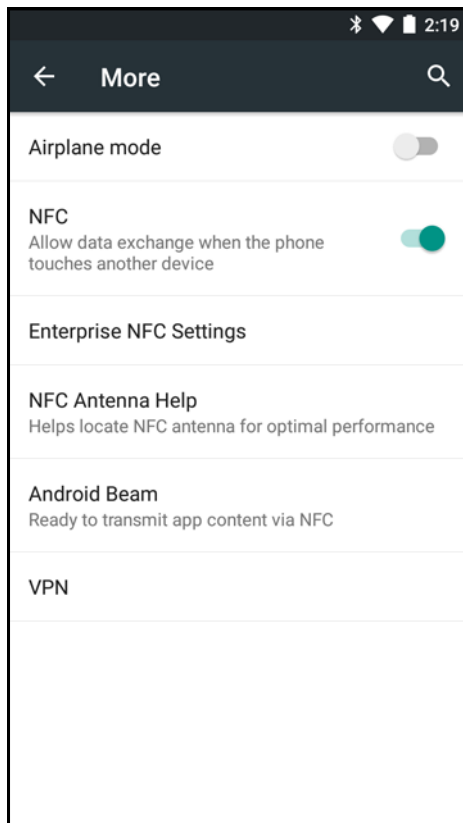









Figure 6-13 *Wireless & Networks Screen*

✓ **NOTE** NFC is enabled by default in TC75 configurations with GMS.

Enabling NFC

1. Touch  > .
2. Touch  **More**.
3. Slide the NFC switch to the **ON** position.
4. Touch .

Disabling NFC

1. Touch  > .
2. Touch  **More**.
3. Slide the NFC switch to the **OFF** position.
4. Touch .

Reading NFC Cards

1. Launch an NFC enabled application.
2. Hold device as shown.

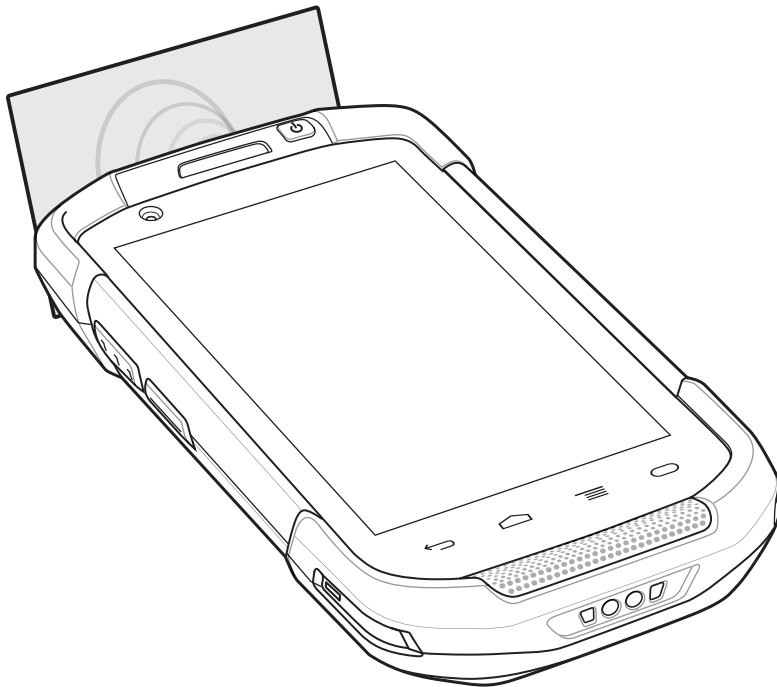

Figure 6-14 *Reading Cards*

3. Move TC75 close to the NFC card until the TC75 detects the card.
4. Hold the card steadily until the transaction is complete (usually indicated by the application).

Sharing Information Using NFC

You can beam content like a web page, contact cards, pictures, YouTube links or location information from your screen to another device by bringing the devices together back to back.

Make sure both devices are unlocked, support NFC, and have both NFC and Android Beam turned on.

1. Open a screen that contains a web page, video, photo or contact.
2. Move the top of the TC75 toward the top of the other device.

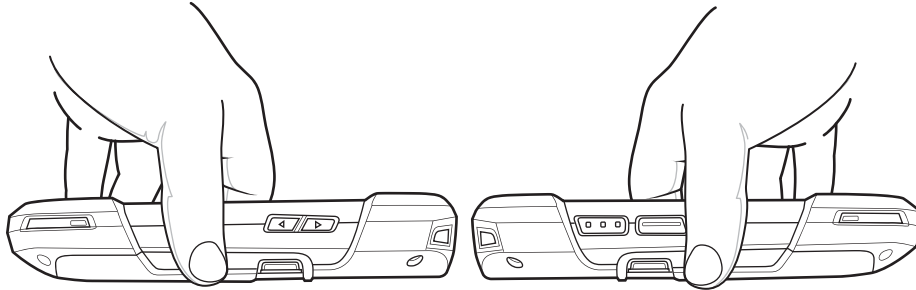

Figure 6-15 *Sharing Data Using NFC*

When the devices connect, you hear a sound, the image on the screen reduces in size, the message **Touch to beam** appears.

3. Touch anywhere on the screen.
The transfer begins.

Enterprise NFC Settings

The Enterprise NFC Settings provides advanced configuration of the NFC radio.

To configure the NFC settings, touch  >  >  **More** > **Enterprise NFC Settings**.

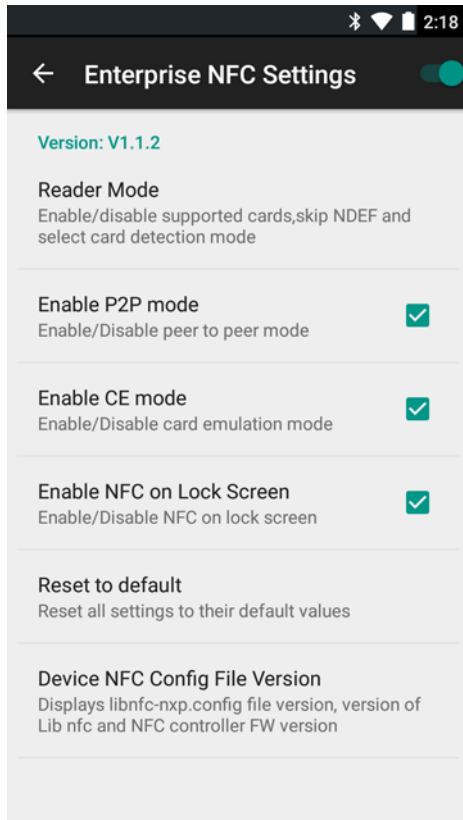

Figure 6-16 *Enterprise NFC Settings Screen*

- **Reader Mode** – Touch to open the Reader Mode setting screen.
- **Enable P2P mode** – Enable or disable peer to peer mode. Default: Enabled.
- **Card Emulation Mode** – Enable or disable card emulation mode. Default: Disabled.
- **Enable CE mode** – Touch to enable or disable card emulation mode. Default: Enabled.
- **Enable NFC on Lock Screen** – Enable or disable NFC on lock screen.
- **Reset to Default** – Reset all NFC settings to factory default settings.

Reader Mode

Use the **Reader Mode** settings to configure the NFC radio.

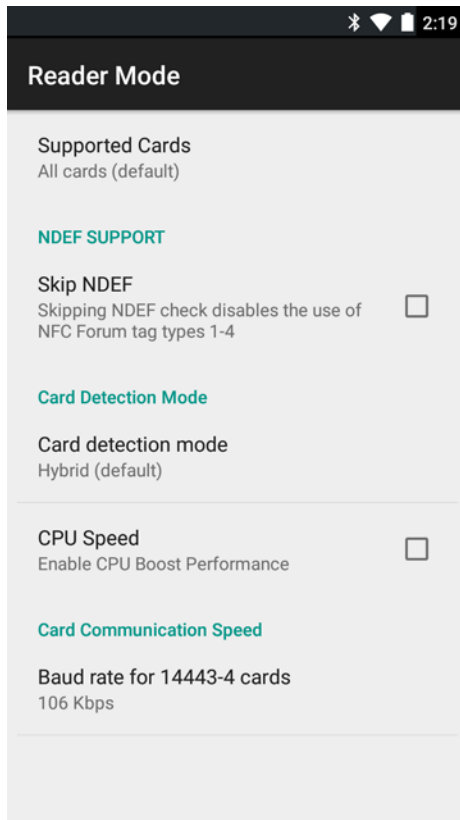

Figure 6-17 *Reader Mode Settings*

- **Supported Cards** – Touch to select the type of NFC cards to support. Options: **All Cards** (default), **Type A**, **Type B**, **Type F** or **Type V**.
- NDEF Support
 - **Skip NDEF** – Enables or disables the use of NFC Forum tag types 1 through 4. Default: Disabled.
- Card Detection Mode
 - **Card detection mode** – Touch to select the card detection mode. Options: **Low power**, **Standard** or **Hybrid** (default).
 - **CPU Speed** – Touch to enhance NFC transaction performance while reading small amounts data. Default: Enabled.
- Card Communication Speed
 - **Baud rate for 14443–4 cards** - Options: **106 kbps** (default), **212 kbps**, **424 kbps** or **848 kbps**.

CHAPTER 7 ACCESSORIES

Introduction

This chapter provides information for using the accessories for the device.

Accessories

This table lists the accessories available for the TC75.

Table 7-1 *TC75 Accessories*

Accessory	Part Number	Description
Cradles		
2-Slot Charge Only Cradle	CRD-TC7X-SEC2U1-01	Provides device and spare battery charging. Use with power supply, p/n PWRS-14000-148R.
2-Slot USB/Ethernet Cradle	CRD-TC7X-SE2EU1-01	Provides device and spare battery charging and USB communication with a host computer and Ethernet communication with a network. Use with power supply, p/n PWRS-14000-148R.
5-Slot Charge Only Cradle	CRD-TC7X-SE5C1-01	Charges up to five devices. Use with power supply, p/n PWRS-14000-241R and DC line cord, p/n 50-16002-029R. Can accommodate one 4-Slot Battery Charger using the Battery Adapter Cup.
5-Slot Ethernet Cradle	CRD-TC7X-SE5EU1-01	Provides device charging and provides Ethernet communication for up to five devices. Use with power supply, p/n PWRS-14000-241R and DC line cord, p/n 50-16002-029R. Can accommodate one 4-Slot Battery Charger using the Battery Adapter Cup.

Table 7-1 TC75 Accessories (Continued)

Accessory	Part Number	Description
Cradle Mount	BRKT-SCRD-SMRK-01	Mounts the 5-Slot Charge Only Cradle, 5-Slot Ethernet Cradle, and 4-Slot Battery Charger to a wall or rack.
Batteries and Chargers		
4,620 mAh PowerPrecision battery	BTRY-TC7X-46MA2-01 BTRY-TC7X-46MA2-10	Replacement battery (single pack). Replacement battery (10-pack).
4-Slot Spare Battery Charger	SAC-TC7X-4BTYC1-01	Charges up to four battery packs. Use with power supply, p/n PWRS-14000-148R.
Battery Charger Adapter Cup	CUP-SE-BTYADP1-01	Allows for one 4-Slot Battery Charger to be charged and docked on the left most slot of the 5-Slot cradles (maximum one per cradle).
Payment		
Magnetic Stripe Reader	MSR-TC7X-SNP1-01	Captures data from magnetic stripe cards.
Vehicle Solutions		
Charging Cable Cup	CHG-TC7X-CLA1-01	Provides power to the device from a cigarette lighter socket.
Charge Only Vehicle Cradle	CRD-TC7X-CVCD1-01	Charges and securely holds the device. Requires power cable CHG-AUTO-CLA1-01 or CHG-AUTO-HWIRE1-01, sold separately.
Cigarette Light Adapter Auto Charge Cable	CHG-AUTO-CLA1-01	Provides power to the Vehicle Cradle from a cigarette lighter socket.
Hard-wire Auto Charge Cable	CHG-AUTO-HWIRE1-01	Provides power to the Vehicle Cradle from the vehicle's power panel.
RAM Mount	RAM-B-166U	Provides window mounting option for the Vehicle Cradle. RAM Twist Lock Suction Cup with Double Socket Arm and Diamond Base Adapter. Overall Length: 6.75".
RAM Mount Base	RAM-B-238U	RAM 2.43" x 1.31" Diamond Ball base with 1" ball.
Charge and Communication Cables		
Charging Cable Cup	CHG-TC7X-CBL1-01	Provides power to the device. Use with power supply, p/n PWRS-14000-249R, sold separately.
Snap-On USB Cable	CBL-TC7X-CBL1-01	Provides power to the device and USB communication with a host computer. Use with power supply, p/n PWRS-14000-249R, sold separately.
Snap-On Serial Cable	CBL-TC7X-SERL1-01	Provides power and serial communication with a host computer. Use with power supply, p/n PWRS-14000-249R, sold separately.

Table 7-1 TC75 Accessories (Continued)

Accessory	Part Number	Description
Snap-On DEX Cable	CBL-TC7X-DEX1-01	Provides electronic data exchange with devices such as vending machines.
Audio Accessories		
2.5 mm Audio Adapter	ADP-TC7X-AUDIO1-01	Snaps onto the device and provides audio to a wired headset with 2.5 mm plug.
2.5 mm Headset	HDST-25MM-PTVP-01	Use for PTT and VoIP calls
Premium Headset	RCH51	Premium Rugged headset.
2.5 mm Quick Disconnect Adapter Cable	25-124387-02R	Provides connection to the RCH50/RCH51 headset.
3.5 mm Audio Adapter	KIT-TC7X-AUDL35-01	Snaps onto the device and provides audio to a wired headset with 3.5 mm plug.
3.5 mm Headset	HDST-35MM-PTVP-01	Use for PTT and VoIP calls.
3.5 mm Quick Disconnect Adapter Cable	ADP-35M-QDCBL1-01	Provides connection to the 3.5 mm Headset.
Scanning		
Trigger Handle	TRG-TC7X-SNP1-02	Adds gun-style handle with a scanner trigger and hand strap for comfortable and productive scanning.
Carrying Solutions		
Soft Holster	SG-TC7X-HLSTR1-02	TC7X soft holster.
Rigid Holster	SG-TC7X-RHLSTR1-01	TC7X rigid holster.
Hand Strap	SG-TC7X-HSTRP1-03	Replacement hand strap with hand strap mounting clip (3-pack).
Stylus and Coiled Tether	SG-TC7X-STYLUS-03	TC7X stylus with coiled tether (3-pack).
Power Supplies		
Power Supply	PWRS-14000-249R	Provides power to the device using the Snap-On USB Cable, Snap-on Serial Cable or Charging Cable Cup. Requires AC line cord.
Power Supply	PWRS-14000-148R	Provides power to the 2-Slot cradles and 4-Slot Spare Battery Charger. Requires AC line cord.

Table 7-1 TC75 Accessories (Continued)

Accessory	Part Number	Description
Power Supply	PWRS-14000-241R	Provides power to the 5-Slot Charge Only cradle and the 5-Slot Ethernet Cradle. Requires DC Line Cord, p/n 50-16002-029R and country specific three wire grounded AC line cord sold separately.
DC Line Cord	50-16002-029R	Provides power from the power supply to the 5-Slot Charge Only Cradle and 5-Slot Ethernet Cradle.

2-Slot Charge Only Cradle

The 2-Slot Charge Only Cradle:

- Provides 5 VDC power for operating the device.
- Charges the device's battery.
- Charges a spare battery.

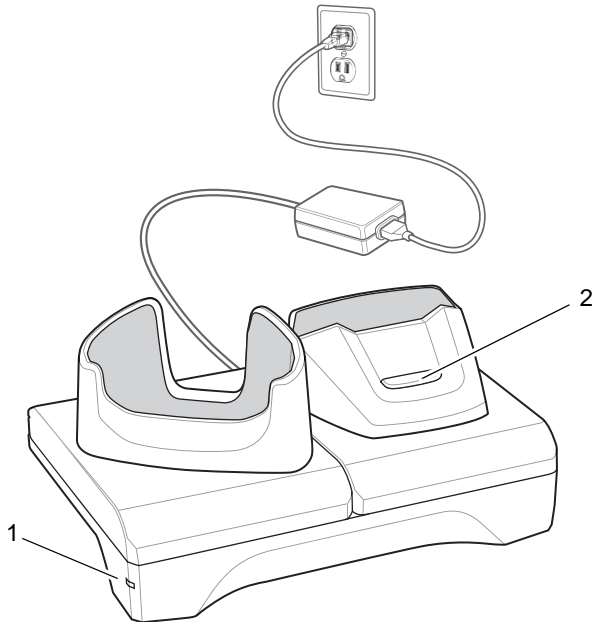

Figure 7-1 2-Slot Charge Only Cradle

- 1 Power LED – Lights green indicating that the cradle is receiving power.
- 2 Spare Battery Charging LED

Charging the Device

1. Insert the device into the slot to begin charging.

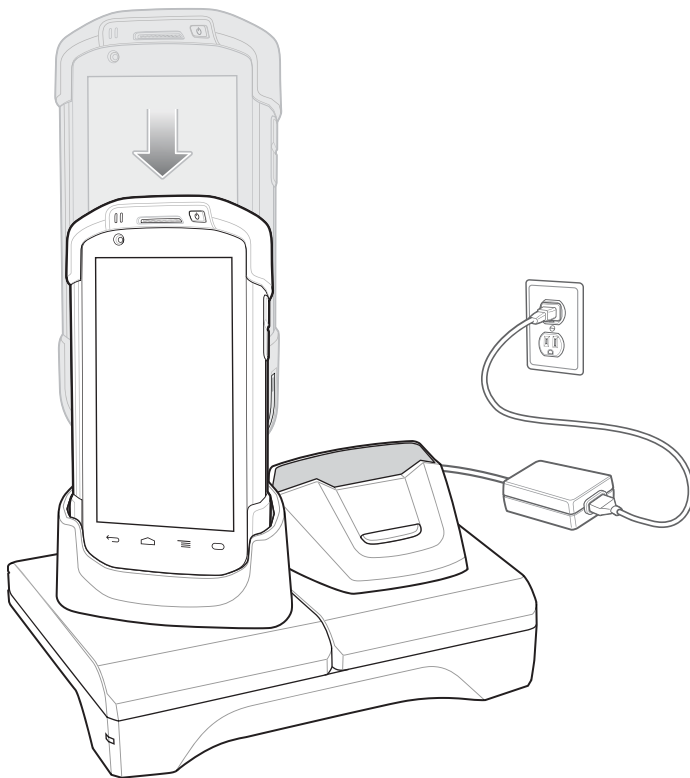

Figure 7-2 *Battery Charging*

2. Ensure the device is seated properly.

Charging the Spare Battery

1. Insert the battery into the right slot to begin charging.

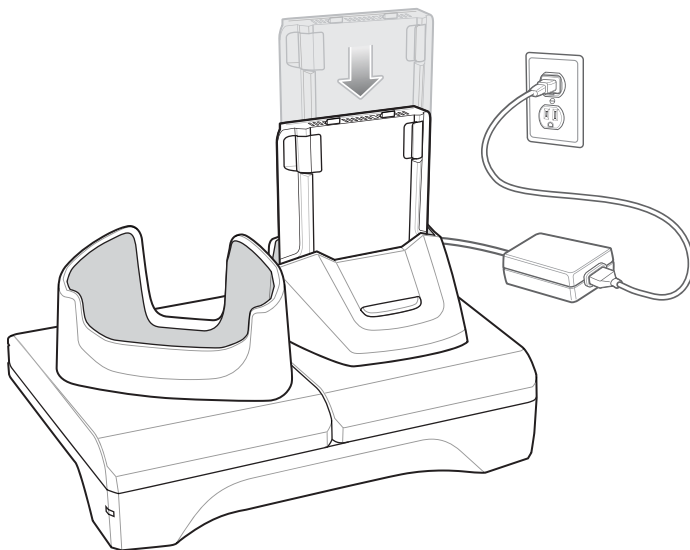

Figure 7-3 *Spare Battery Charging*

2. Ensure the battery is seated properly.

Battery Charging

Main Battery Charging

The device's Charging/Notification LED indicates the status of the battery charging in the device.

The 4,620 mAh battery fully charges in less than six hours at room temperature.

Spare Battery Charging

The Spare battery Charging LED on the cup indicates the status of the spare battery charging.

The 4,620 mAh battery fully charges in less than six hours at room temperature.

Table 7-2 Spare Battery Charging LED Indicators

LED	Indication
Slow Blinking Amber	Spare battery is charging.
Solid Green	Charging complete.
Fast Blinking Amber	Error in charging; check placement of spare battery.
Slow Blinking Red	Spare battery is charging and battery is at the end of useful life.
Solid Red	Charging complete and battery is at the end of useful life.
Fast Blinking Red	Error in charging; check placement of spare battery and battery is at the end of useful life.
Off	No spare battery in slot; spare battery not placed correctly; cradle is not powered.

Charging Temperature

Charge batteries in temperatures from 0°C to 40°C (32°F to 104°F). The device or cradle always performs battery charging in a safe and intelligent manner. At higher temperatures (e.g. approximately +37°C (+98°F)) the device or cradle may for small periods of time alternately enable and disable battery charging to keep the battery at acceptable temperatures. The device and cradle indicates when charging is disabled due to abnormal temperatures via its LED.

2-Slot USB/Ethernet Cradle

The 2-Slot USB/Ethernet Cradle:

- Provides 5.0 VDC power for operating the device.
- Charges the device's battery.
- Charges a spare battery.
- Connects the device to an Ethernet network.
- Provides communication to a host computer using a USB cable.

✓ **NOTE** Remove all attachments on the device, except the hand strap, before place onto the cradle.

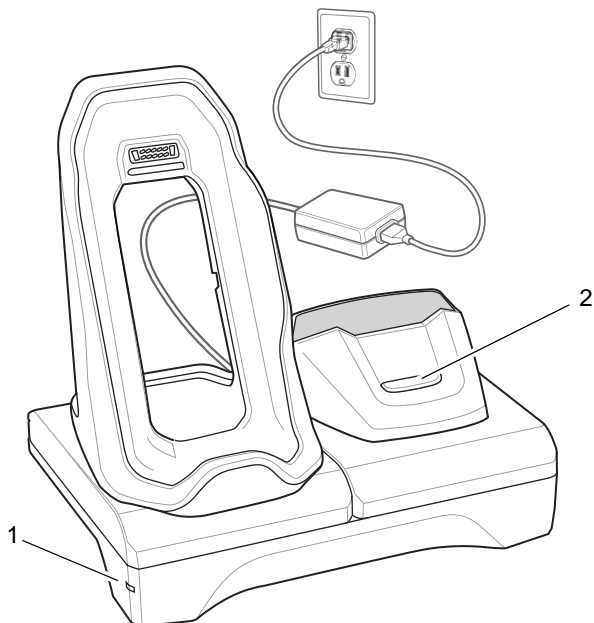

Figure 7-4 2-Slot USB/Ethernet Cradle

- 1 Power LED – Lights green indicating that the cradle is receiving power.
- 2 Spare Battery Charging LED

Charging the Device

1. Place the bottom of the device into the base.

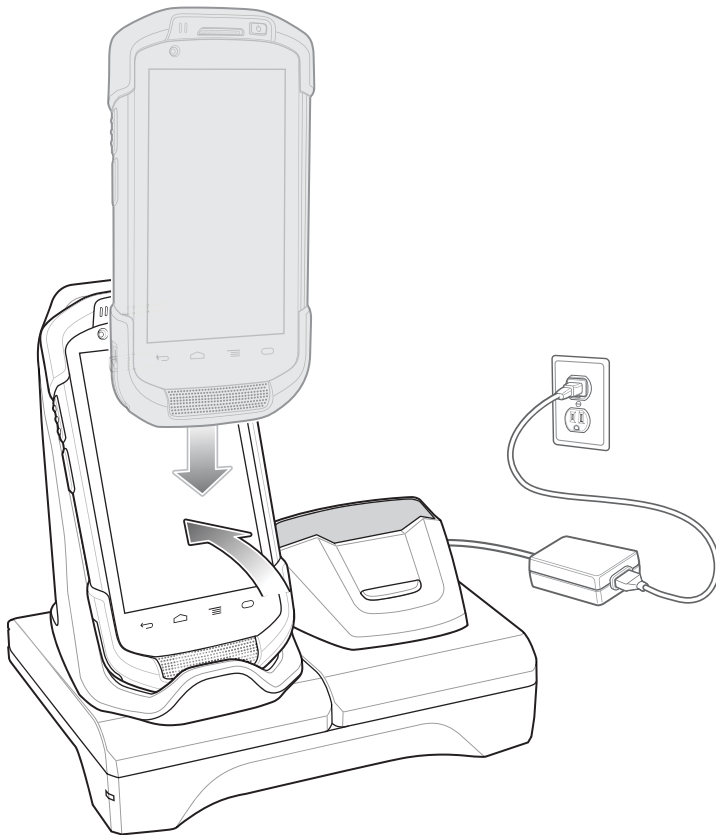

Figure 7-5 *Battery Charging*

2. Rotate the top of the device until the connector on the back of the device mates with the connector on the cradle.
3. Ensure the device is connected properly. The charging Charging/Notification LED on the device begins blinking amber indicating that the device is charging.

Charging the Spare Battery

1. Insert the battery into the right slot to begin charging.

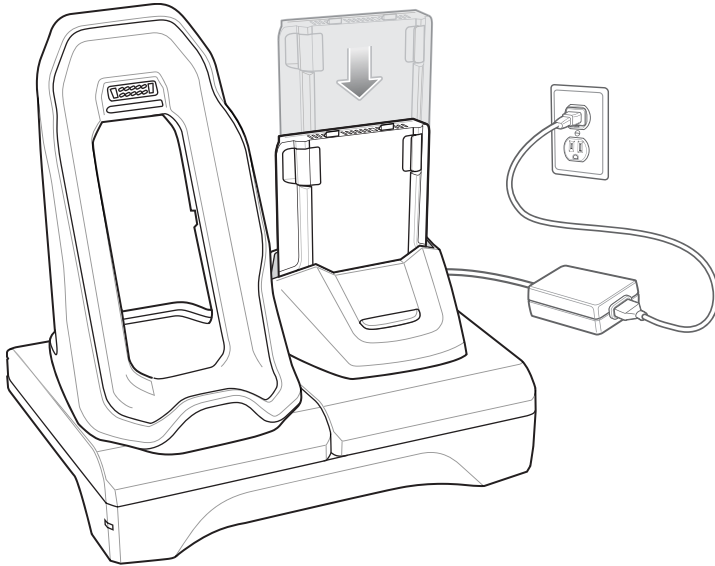

Figure 7-6 Spare Battery Charging

2. Ensure the battery is seated properly.

Battery Charging

Main Battery Charging

The device's Charging/Notification LED indicates the status of the battery charging in the device.

The 4,620 mAh battery fully charges in less than six hours at room temperature.

Spare Battery Charging

The Spare battery Charging LED on the cup indicates the status of the spare battery charging.

The 4,620 mAh battery fully charges in less than six hours at room temperature.

Table 7-3 Spare Battery Charging LED Indicators

LED	Indication
Slow Blinking Amber	Spare battery is charging.
Solid Green	Charging complete.
Fast Blinking Amber	Error in charging; check placement of spare battery.
Slow Blinking Red	Spare battery is charging and battery is at the end of useful life.
Solid Red	Charging complete and battery is at the end of useful life.

Table 7-3 Spare Battery Charging LED Indicators (Continued)

LED	Indication
Fast Blinking Red	Error in charging; check placement of spare battery and battery is at the end of useful life.
Off	No spare battery in slot; spare battery not placed correctly; cradle is not powered.

Charging Temperature

Charge batteries in temperatures from 0 °C to 40 °C (32 °F to 104 °F). The device or cradle always performs battery charging in a safe and intelligent manner. At higher temperatures (e.g. approximately +37 °C (+98 °F)) the device or cradle may for small periods of time alternately enable and disable battery charging to keep the battery at acceptable temperatures. The device and cradle indicates when charging is disabled due to abnormal temperatures via its LED.

USB/Ethernet Communication

The 2-Slot USB/Ethernet Cradle provides both Ethernet communication with a network and USB communication with a host computer. Prior to using the cradle for Ethernet or USB communication. Ensure that the switch on the USB/Ethernet module is set properly.

Turn the cradle over to view the module.

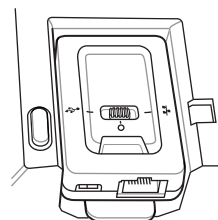
**Figure 7-7** 2-Slot USB/Ethernet Cradle Module Switch

For Ethernet communication, slide the switch to the  position.

For USB communication, slide the switch to the  position.

Place the switch in the center position  to disable communications.

Ethernet LED Indicators

There are two LEDs on the USB/Ethernet Module RJ-45 connector. The green LED lights to indicate that the transfer rate is 100 Mbps. When the LED is not lit the transfer rate is 10 Mbps. The yellow LED blinks to indicate activity, or stays lit to indicate that a link is established. When it is not lit it indicates that there is no link.

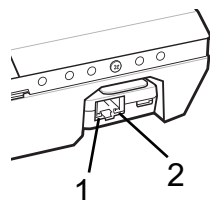



**Figure 7-8** LED Indicators

Table 7-4 USB/Ethernet Module LED Data Rate Indicators

Data Rate	(1) Yellow LED	(2) Green LED
100 Mbps	On/Blink	On
10 Mbps	On/Blink	Off

Establishing Ethernet Connection

✓ **NOTE** Refer to the *TC75 Integrator Guide* for information on configuring the Ethernet settings.

1. Touch .
2. Touch .
3. Touch  **Ethernet**.
4. Insert the device into a slot.
5. Slide the Ethernet switch to the **ON** position.
The  icon appears in the Status bar.
6. Touch **Eth0** to view Ethernet connection details.

5-Slot Charge Only Cradle

The 5-Slot Charge Only Cradle:

- Provides 5 VDC power for operating the TC75.
- Simultaneously charges up to five TC75s and up to four TC75s and on 4-Slot Battery Charger using the Battery Charger Adapter. See the *TC75 Integrator Guide* for information on installing the 4-Slot Battery Charger onto the cradle.
- Consists of a cradle base and cups that can be configured for various charging requirements.

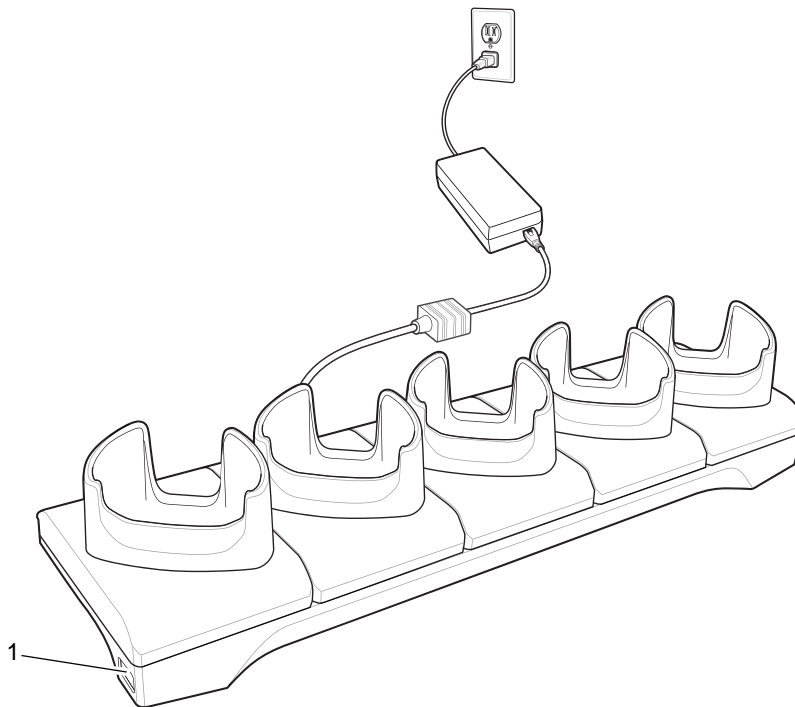

Figure 7-9 5-Slot Charge Only Cradle

- 1 Power LED – Lights green when power is applied to cradle.

Charging the TC75

1. Insert the TC75 into a slot to begin charging.

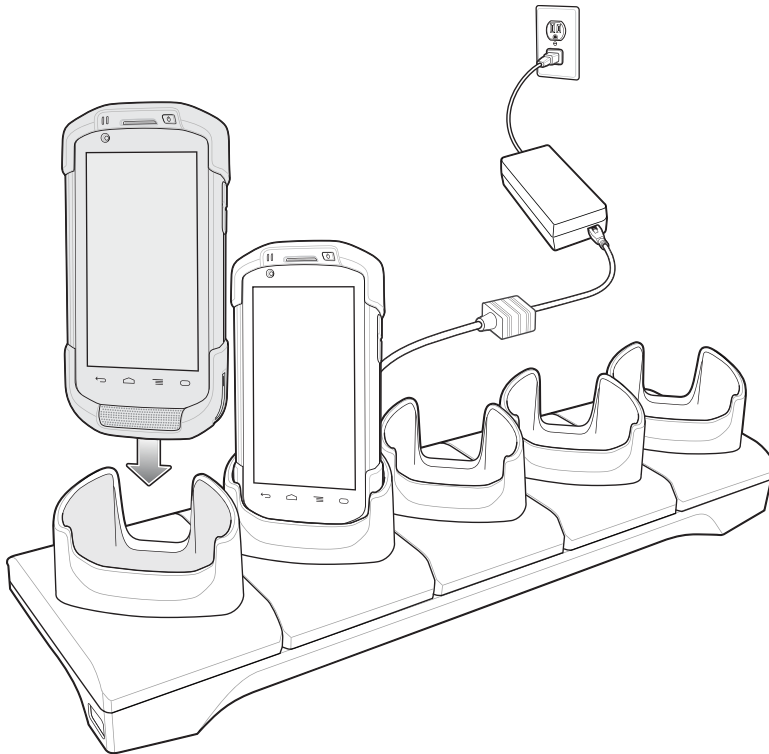

Figure 7-10 TC75 Battery Charging

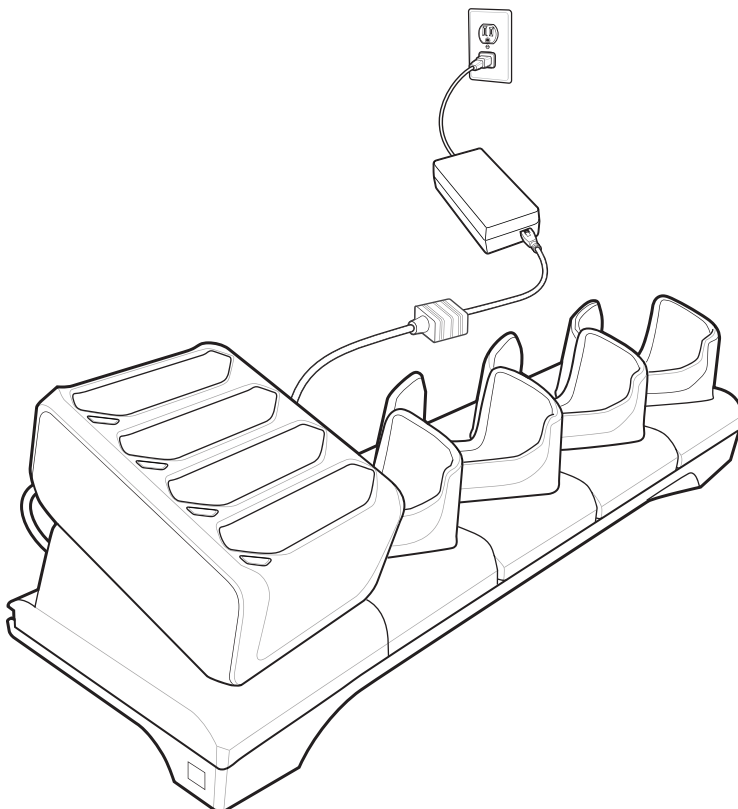

Figure 7-11 5-Slot Charge Only Cradle with Four Slot Battery Charger

2. Ensure the TC75 is seated properly.



NOTE Refer to the *TC75 Integrator Guide* for information on installing the 4-Slot Battery Charger onto the cradle.

Battery Charging

Main Battery Charging

The device's Charging/Notification LED indicates the status of the battery charging in the device.

The 4,620 mAh battery fully charges in less than six hours at room temperature.

Spare Battery Charging

The Spare battery Charging LED on the cup indicates the status of the spare battery charging.

The 4,620 mAh battery fully charges in less than six hours at room temperature.

Table 7-5 Spare Battery Charging LED Indicators

LED	Indication
Slow Blinking Amber	Spare battery is charging.
Solid Green	Charging complete.
Fast Blinking Amber	Error in charging; check placement of spare battery.
Slow Blinking Red	Spare battery is charging and battery is at the end of useful life.
Solid Red	Charging complete and battery is at the end of useful life.
Fast Blinking Red	Error in charging; check placement of spare battery and battery is at the end of useful life.
Off	No spare battery in slot; spare battery not placed correctly; cradle is not powered.

Charging Temperature

Charge batteries in temperatures from 0 °C to 40 °C (32 °F to 104 °F). The device or cradle always performs battery charging in a safe and intelligent manner. At higher temperatures (e.g. approximately +37 °C (+98 °F)) the device or cradle may for small periods of time alternately enable and disable battery charging to keep the battery at acceptable temperatures. The device and cradle indicates when charging is disabled due to abnormal temperatures via its LED.

5-Slot Ethernet Cradle



CAUTION Ensure that you follow the guidelines for battery safety described in Battery Safety Guidelines.

The 5-Slot Ethernet Cradle:

- Provides 5.0 VDC power for operating the device.
- Connects the device (up to five) to an Ethernet network.
- Simultaneously charges up to five TC75s and up to four TC75s and on 4-Slot Battery Charger using the Battery Charger Adapter. Refer to the *TC75 Integrator Guide* for information on installing the 4-Slot Battery Charger onto the cradle.

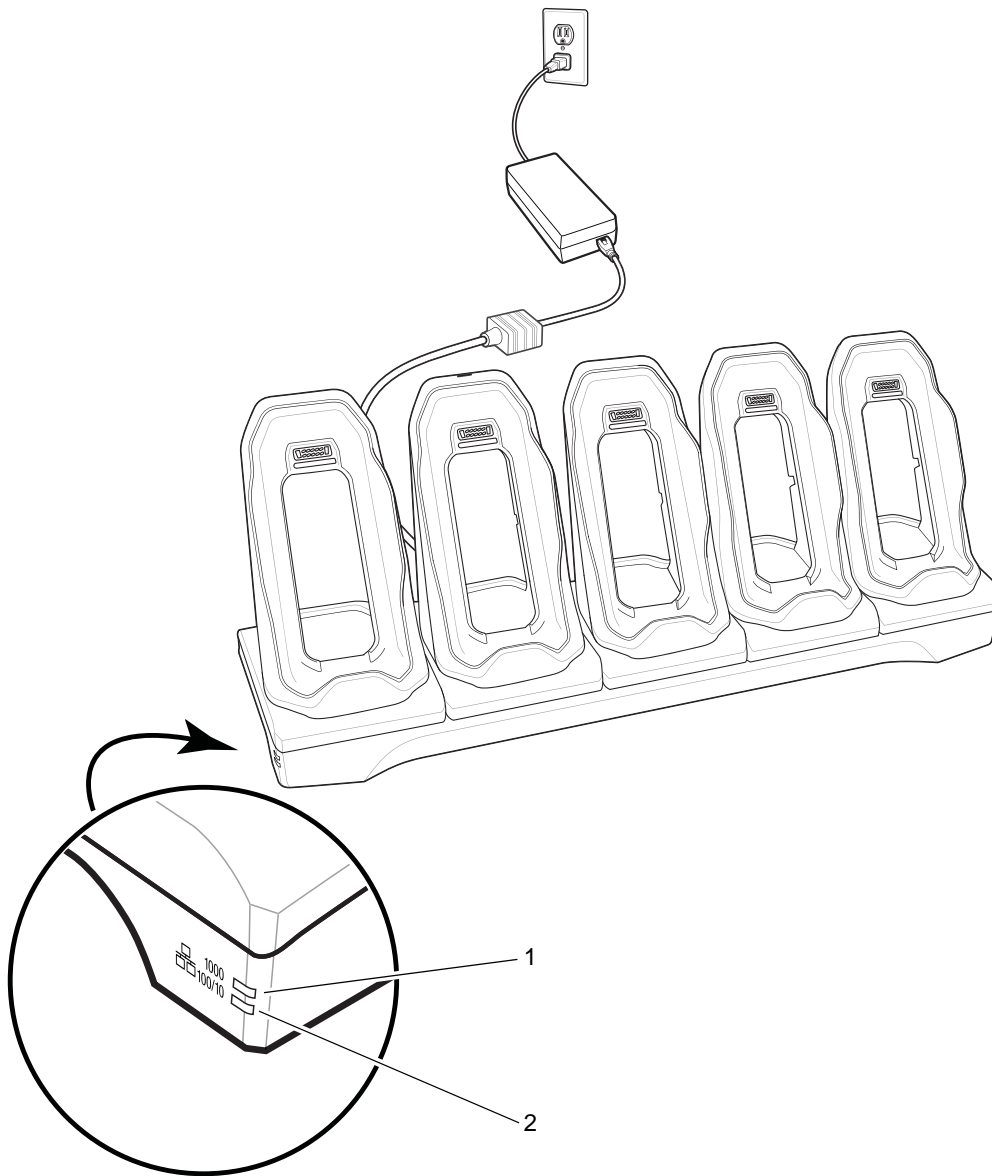

Figure 7-12 5-Slot Ethernet Cradle

- 1 1000 LED – Indicates 1 Gbps data rate.
- 2 100/10 LED – Indicates 100 Mbps or 10 Mbps data rate.

Charging the TC75

1. Insert the TC75 into a slot to begin charging.

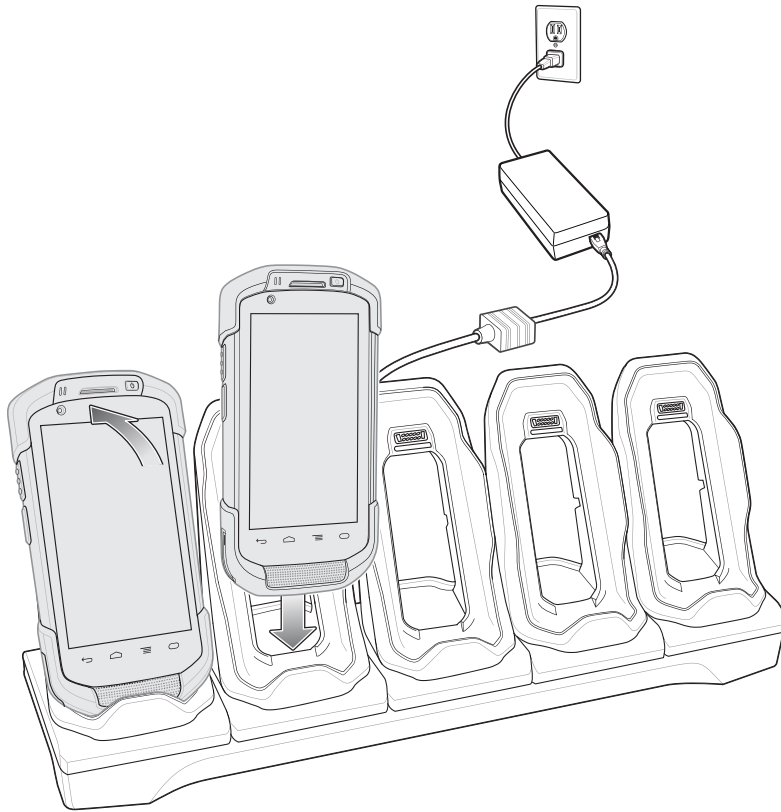

Figure 7-13 *TC75 Battery Charging*

2. Ensure the TC75 is seated properly.

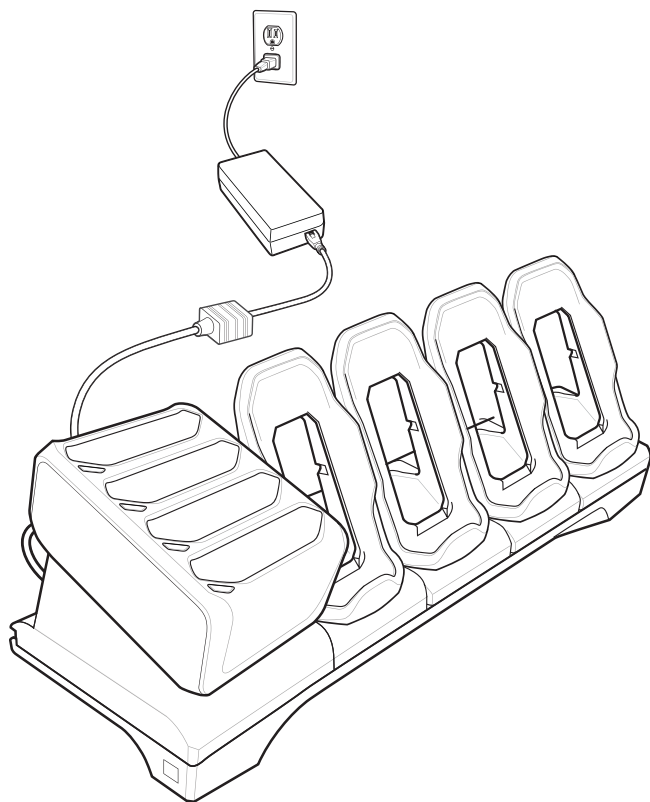

Figure 7-14 5-Slot Ethernet Cradle with 4-Slot Battery Charger

✓ **NOTE** Refer to the *TC75 Integrator Guide* for information on installing the 4-Slot Battery Charger onto the cradle.

Battery Charging

Main Battery Charging

The device's Charging/Notification LED indicates the status of the battery charging in the device.

The 4,620 mAh battery fully charges in less than six hours at room temperature.

Spare Battery Charging

The Spare battery Charging LED on the cup indicates the status of the spare battery charging.

The 4,620 mAh battery fully charges in less than six hours at room temperature.

Table 7-6 Spare Battery Charging LED Indicators

LED	Indication
Slow Blinking Amber	Spare battery is charging.
Solid Green	Charging complete.
Fast Blinking Amber	Error in charging; check placement of spare battery.

Table 7-6 Spare Battery Charging LED Indicators (Continued)





LED	Indication
Slow Blinking Red	Spare battery is charging and battery is at the end of useful life.
Solid Red	Charging complete and battery is at the end of useful life.
Fast Blinking Red	Error in charging; check placement of spare battery and battery is at the end of useful life.
Off	No spare battery in slot; spare battery not placed correctly; cradle is not powered.

Charging Temperature

Charge batteries in temperatures from 0 °C to 40 °C (32 °F to 104 °F). The device or cradle always performs battery charging in a safe and intelligent manner. At higher temperatures (e.g. approximately +37 °C (+98 °F)) the device or cradle may for small periods of time alternately enable and disable battery charging to keep the battery at acceptable temperatures. The device and cradle indicates when charging is disabled due to abnormal temperatures via its LED.

Establishing Ethernet Connection

✓ **NOTE** Refer to the *TC75 Integrator Guide* for information on configuring the Ethernet settings.

1. Touch .
2. Touch .
3. Touch  **Ethernet**.
4. Insert the device into a slot.
5. Slide the Ethernet switch to the **ON** position.
The  icon appears in the Status bar.
6. Touch **Ethernet Information** to view Ethernet connection details.

LED Indicators

There are two green LEDs on the side of the cradle. These green LEDs light and blink to indicate the data transfer rate.

Table 7-7 LED Data Rate Indicators

Data Rate	1000 LED	100/10 LED
1 Gbps	On/Blink	Off
100 Mbps	Off	On/Blink
10 Mbps	Off	On/Blink

4-Slot Battery Charger

This section describes how to use the 4-Slot Battery Charger to charge up to four TC75 batteries.

Charging Spare Batteries

1. Connect the charger to a power source.
2. Insert the battery into a battery charging well and gently press down on the battery to ensure proper contact.

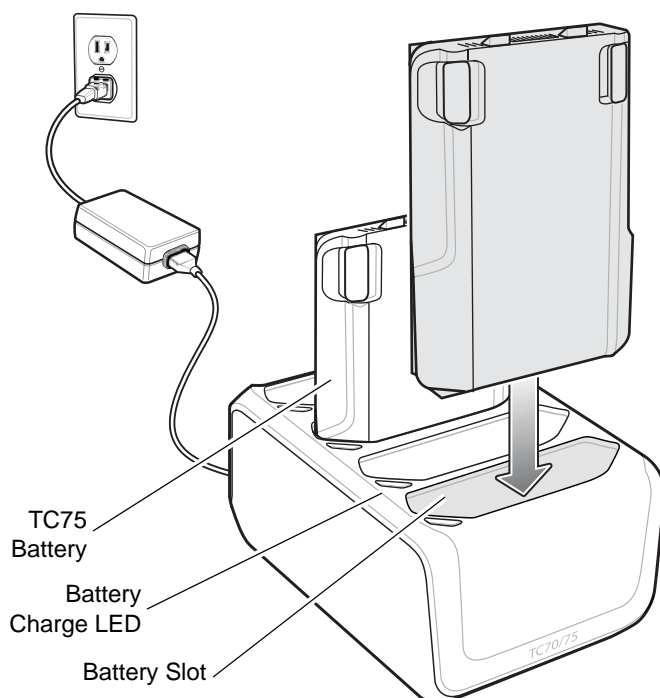

Figure 7-15 4-Slot Battery Charger

Battery Charging

Spare Battery Charging

Each Battery Charging LED indicates the status of the battery charging in each slot. The table below describes the Battery Charging LED status.

The 4,620 mAh battery fully charges in less than six hours at room temperature.

Table 7-8 Battery LED Charging Indicators

LED	Indication
Slow Blinking Amber	Spare battery is charging.
Solid Green	Charging complete.
Fast Blinking Amber	Error in charging; check placement of spare battery.

Table 7-8 Battery LED Charging Indicators (Continued)

LED	Indication
Slow Blinking Red	Spare battery is charging and battery is at the end of useful life.
Solid Red	Charging complete and battery is at the end of useful life.
Fast Blinking Red	Error in charging; check placement of spare battery and battery is at the end of useful life.
Off	No spare battery in slot; spare battery not placed correctly; cradle is not powered.

Charging Temperature

Charge batteries in temperatures from 0 °C to 40 °C (32 °F to 104 °F). The battery charger always performs battery charging in a safe and intelligent manner. At higher temperatures (e.g. approximately +37 °C (+98 °F)) the battery charger may for small periods of time alternately enable and disable battery charging to keep the battery at acceptable temperatures. The battery charger indicates when charging is disabled due to abnormal temperatures via its LED.

Magnetic Stripe Reader

The MSR snaps on to the back of the TC75 and removes easily when not in use. When attached to the TC75, the MSR allows the TC75 to capture data from magnetic stripe cards.

For battery optimization, remove when not in use.

Attaching the MSR

1. Align the top mounting points on the MSR with the mounting slots on the TC75.

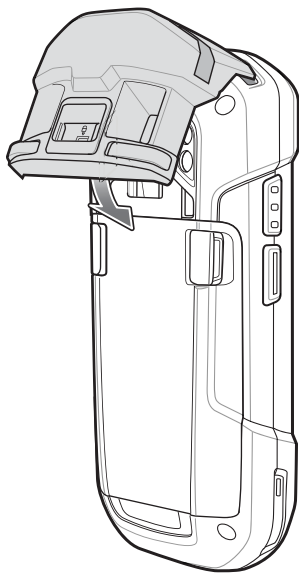

Figure 7-16 MSR Installation

2. Rotate the MSR down and press down until it snaps into position.
3. Using a flat end plastic tool, slide the lock switch down to lock the MSR.

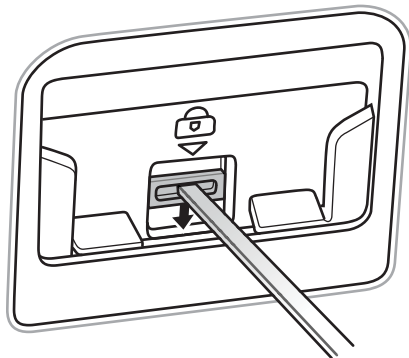

Figure 7-17 Lock MSR

Removing the MSR

1. Using a flat end plastic tool, slide the lock switch up to unlock the MSR.

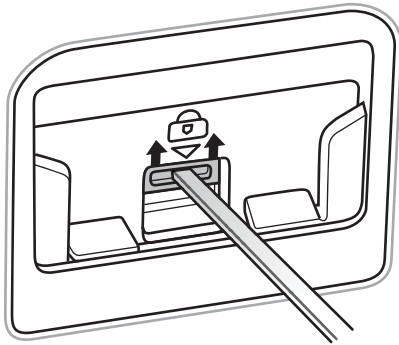

Figure 7-18 *Unlock MSR*

2. Press the two release buttons.

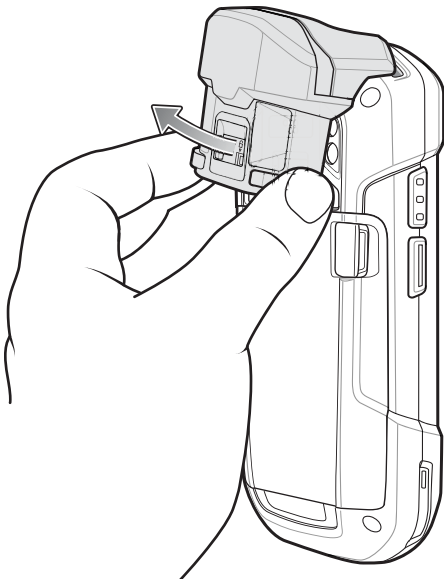

Figure 7-19 *Remove MSR*

3. Rotate the MSR away from the TC75 and lift.

Reading Magnetic Stripe Cards

Use the integrated MSR to read magnetic stripe card.

1. Ensure that **MSR input** is enabled in DataWedge and the cursor is in a text field.
2. Grip TC75 firmly in one hand.
3. Hold magnetic stripe card firmly in the other hand.
4. Align the magnetic stripe on the card away from the display and swipe the card smoothly in either direction.

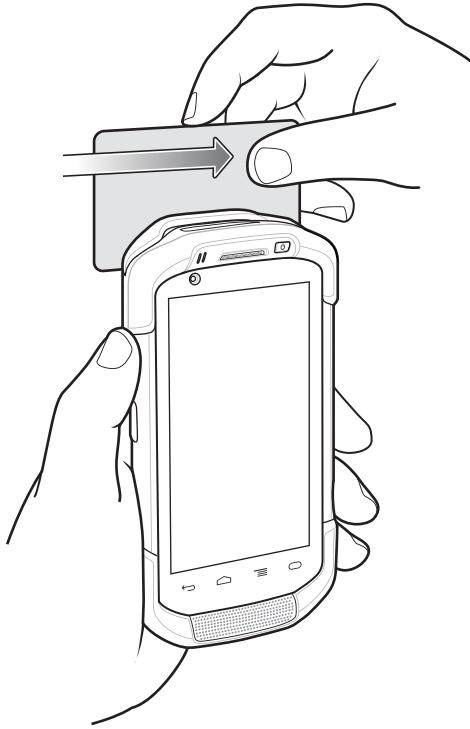

Figure 7-20 *Swiping a Magnetic Stripe Card*

5. Depending upon the application, the captured data appears.

2.5 mm Audio Adapter

The 2.5 mm Audio Adapter snaps onto the back of the TC75 and removes easily when not in use. When attached to the TC75, the Audio Adapter allows a user to connect a wired headset to the TC75.

Attaching the 2.5 mm Audio Adapter

1. Align the top mounting points on the Audio Adapter with the mounting slots on the TC75.

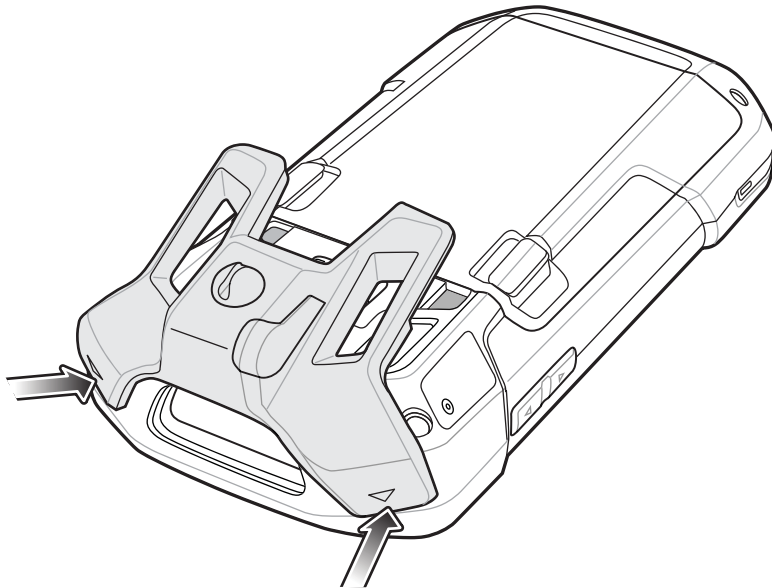

Figure 7-21 *Audio Adapter Installation*

2. Rotate the Audio Adapter down and press down until it snaps into position.

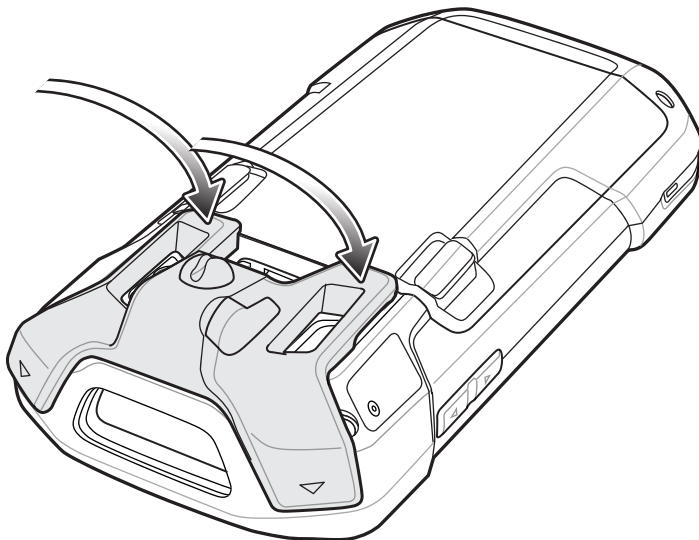

Figure 7-22 *Rotate Audio Adapter onto TC75*

Connecting a Headset to the Audio Adapter

1. Lift the rubber plug from the audio jack.
2. Insert the headset plug into the jack on the Audio Adapter.

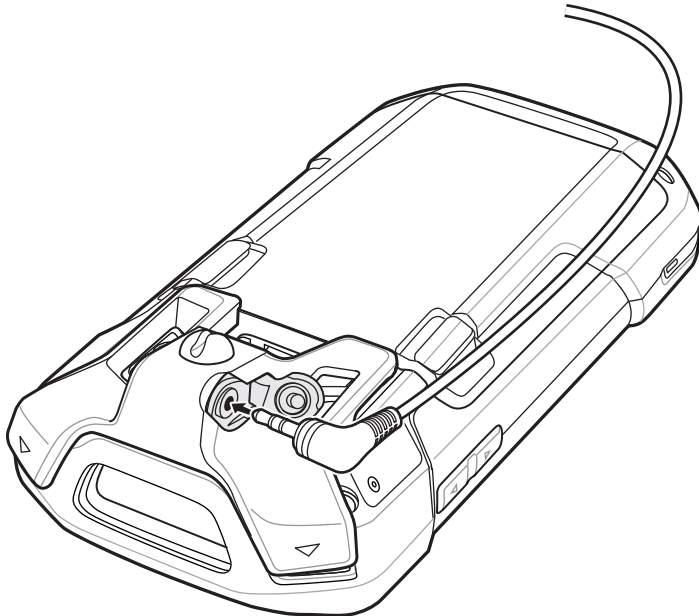

Figure 7-23 *Connect Headset to Audio Adapter*

3. Press the headset wire into the wire holder on the Audio Adapter.

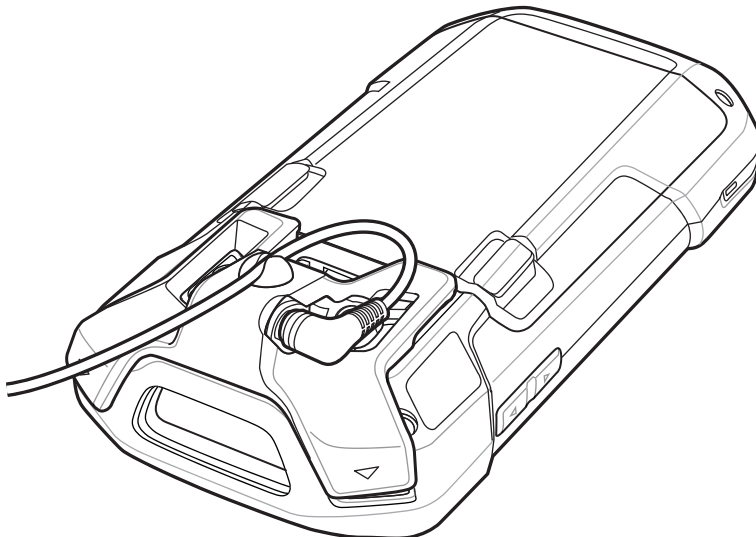

Figure 7-24 *Secure Headset Wire*

Device with Audio Adapter in Holster

When using the TC75 and the audio adapter in a holster, ensure that the display faces in and the headset cable is securely attached to the audio adapter.

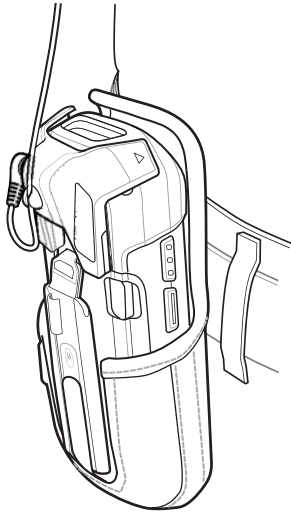

Figure 7-25 *Device with Audio Adapter in Holster*

Removing the 2.5 mm Audio Adapter

1. Disconnect headset plug from 2.5 mm Audio Adapter.
2. Lift the bottom of the Audio Adapter away from the TC75.

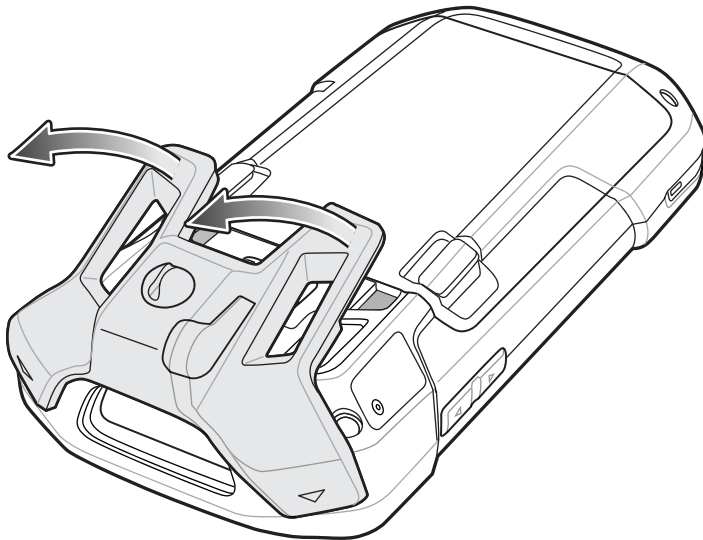

Figure 7-26 *Remove Audio Adapter from TC75*

3. Remove Audio Adapter from the TC75.

3.5 mm Audio Adapter

The 3.5 mm Audio Adapter snaps onto the back of the TC75 and removes easily when not in use. When attached to the TC75, the 3.5 mm Audio Adapter allows a user to connect a wired headset to the TC75.

Connecting a Headset to the 3.5 mm Audio Adapter

1. Connect the Quick Disconnect connect of the headset to the Quick Disconnect connector of the 3.5 mm Quick Disconnect Adapter Cable.

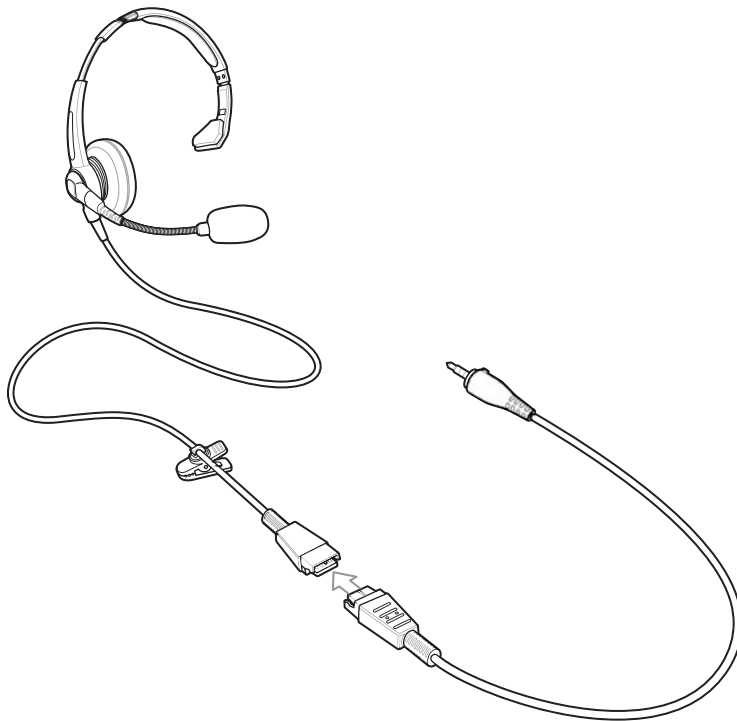

Figure 7-27 *Connect Headset to Adapter Cable*

2. Connect the audio jack of the 3.5 mm Quick Disconnect Adapter Cable to the 3.5 mm Audio Adapter.

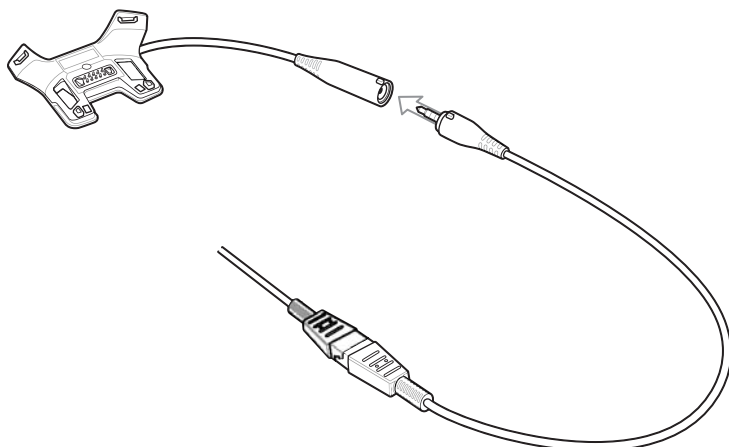

Figure 7-28 *Connect Adapter Cable to Audio Adapter*

Attaching the 3.5 mm Audio Adapter

1. Align the top mounting points on the 3.5 mm Audio Adapter with the mounting slots on the TC75.

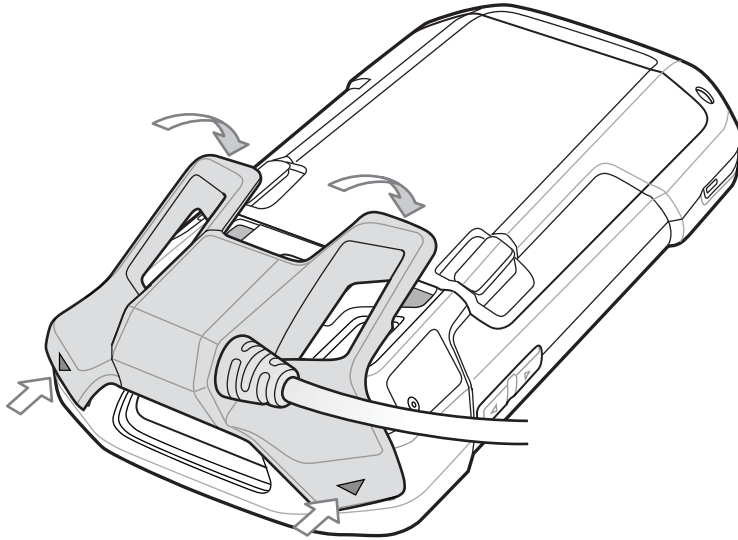

Figure 7-29 *Audio Adapter Installation*

2. Rotate the Audio Adapter down and press down until it snaps into position.

Device with 3.5 mm Audio Adapter in Holster

When using the TC75 and the audio adapter in a holster, ensure that the display faces in and the headset cable is securely attached to the audio adapter.

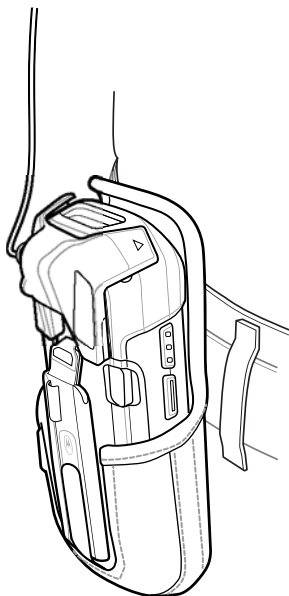

Figure 7-30 *Device with 3.5 mm Audio Adapter in Holster*

Removing the 3.5 mm Audio Adapter

1. Disconnect headset plug from 3.5 mm Audio Adapter.

2. Lift the bottom of the Audio Adapter away from the TC75.

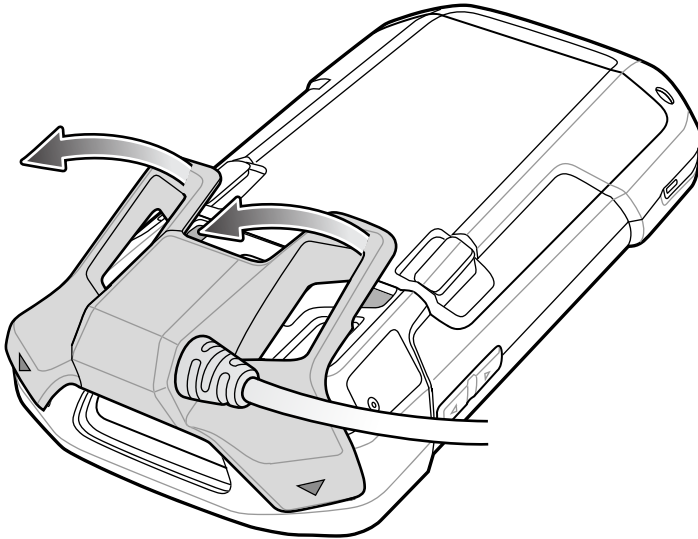

Figure 7-31 *Remove Audio Adapter from TC75*

3. Remove Audio Adapter from the TC75.

Snap-On USB Cable

The Snap-On USB Cable snaps on to the back of the TC75 and removes easily when not in use. When attached to the TC75, the Snap-On USB Cable allows the TC75 to transfer data to a host computer and provide power for charging the TC75.

Connecting to TC75

1. Align the top mounting points on the cable with the mounting slots on the TC75.

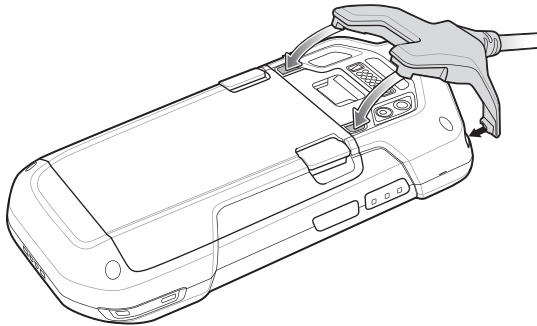

Figure 7-32 *Cable Installation*

2. Rotate the cable down and press until it snaps into place. Magnetics hold the cable to the TC75.

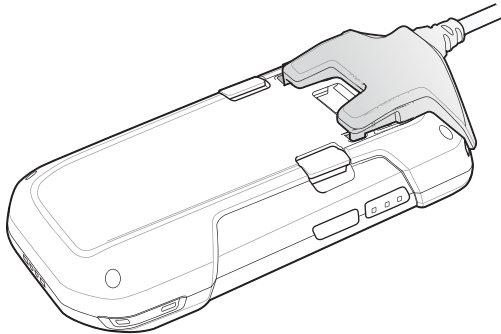

Figure 7-33 *Cable Attached to TC75*

USB Communication

1. Connect the Snap-On USB Cable to the TC75.

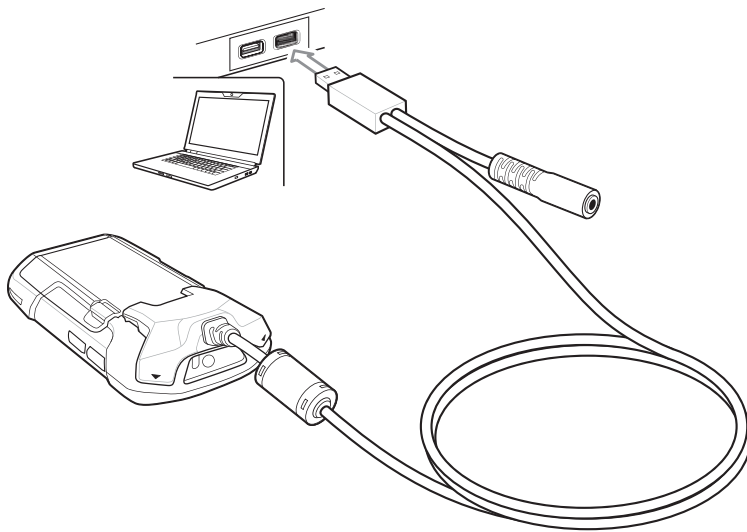

Figure 7-34 *Cable Removed from TC75*

2. Connect the USB connector of the cable to a host computer.

Charging the TC75

1. Connect the Snap-On USB Cable to the TC75.
2. Connect the power supply to the Snap-On USB Cable

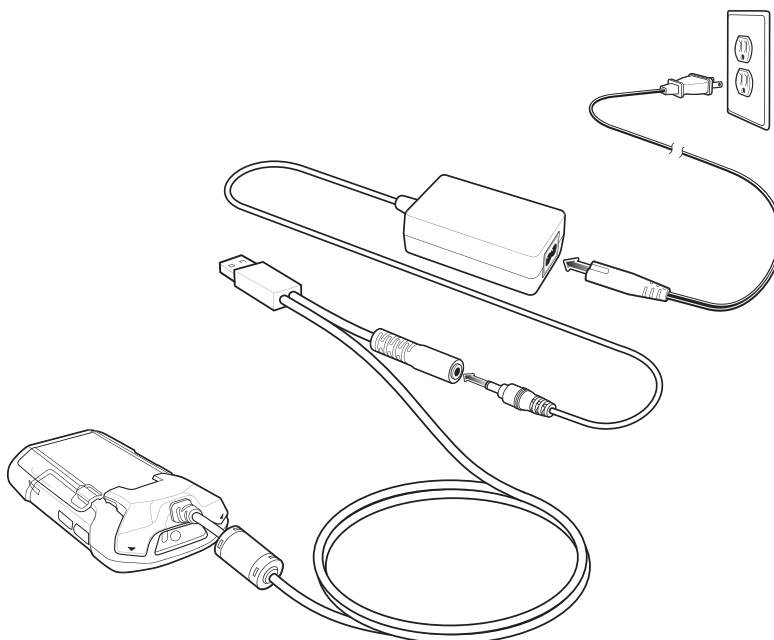

Figure 7-35 *Power Setup*

3. Connect to the power supply to an AC outlet.

Disconnecting from TC75

1. Press down on the cable.

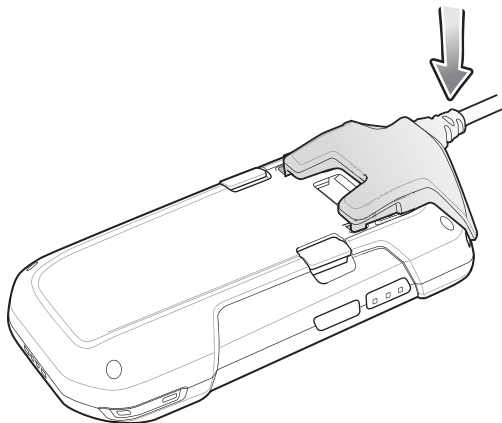

Figure 7-36 *Press Down on Cable*

2. Rotate away from the TC75. The magnetics release the cable from the TC75.

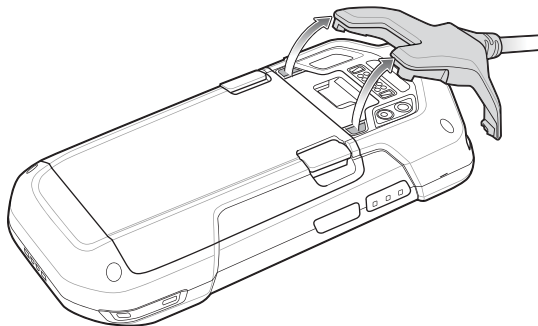

Figure 7-37 *Remove Cable from TC75*

Battery Charging

Main Battery Charging

The device's Charging/Notification LED indicates the status of the battery charging in the device.

The 4,620 mAh battery fully charges in less than six hours at room temperature.

Charging Temperature

Charge batteries in temperatures from 0 °C to 40 °C (32 °F to 104 °F). The device always performs battery charging in a safe and intelligent manner. At higher temperatures (e.g. approximately +37 °C (+98 °F)) the device may for small periods of time alternately enable and disable battery charging to keep the battery at acceptable temperatures. The device indicates when charging is disabled due to abnormal temperatures via its LED.

Charging Cable Cup

This section describes how to use the Charging Cable Cup to charge the TC75.

Charging the TC75

1. Insert the TC75 into the cup of the Charging Cable Cup.

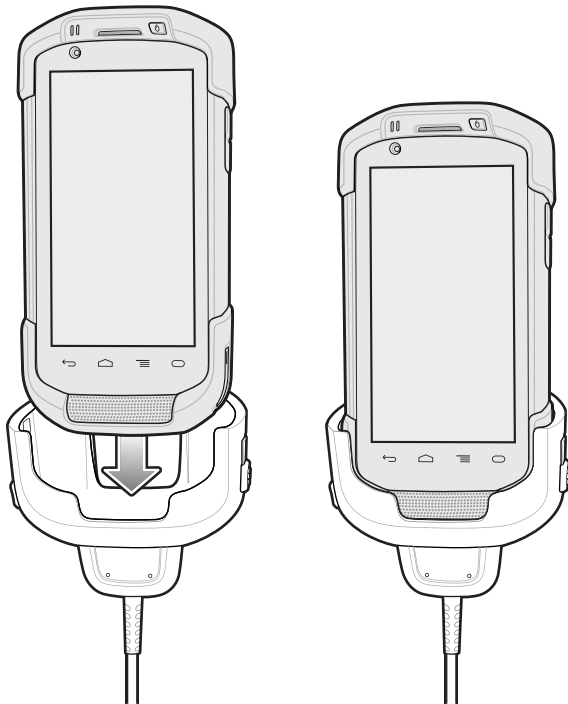

Figure 7-38 *TC75 Charging*

2. Ensure the TC75 is seated properly.
3. Slide the two yellow locking tabs up to lock the cable to the TC75.

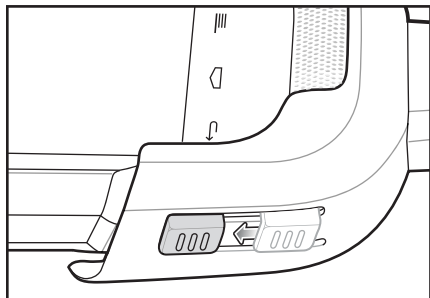

Figure 7-39 *Lock Cable Cup*

4. Connect the power supply to the Charging Cable Cup and to a power source.

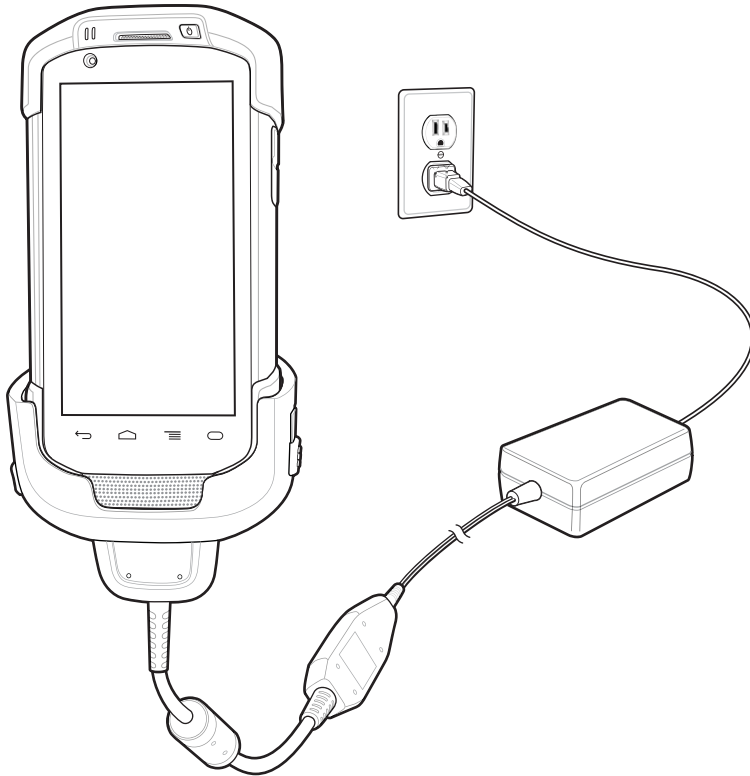

Figure 7-40 *Connect Cable to Power Supply*

Battery Charging

Main Battery Charging

The device's Charging/Notification LED indicates the status of the battery charging in the device.

The 4,620 mAh battery fully charges in less than six hours at room temperature.

Charging Temperature

Charge batteries in temperatures from 0 °C to 40 °C (32 °F to 104 °F). The device always performs battery charging in a safe and intelligent manner. At higher temperatures (e.g. approximately +37 °C (+98 °F)) the device may for small periods of time alternately enable and disable battery charging to keep the battery at acceptable temperatures. The device indicates when charging is disabled due to abnormal temperatures via its LED.

Snap-On DEX Cable

The Snap-On DEX Cable snaps on to the back of the TC75 and removes easily when not in use. When attached to the TC75, the Snap-On DEX Cable provides electronic data exchange with devices such as vending machines.

Connecting to TC75

1. Align the top mounting points on the cable with the mounting slots on the TC75.

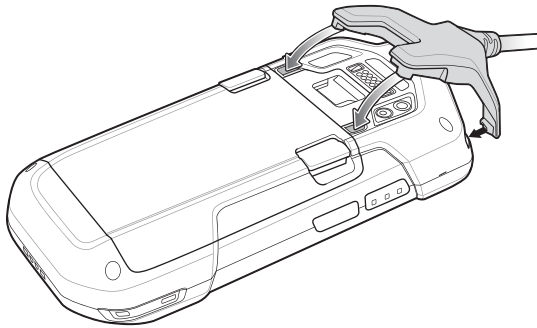

Figure 7-41 *Cable Installation*

2. Rotate the cable down and press until it snaps into place. Magnetics hold the cable to the TC75.

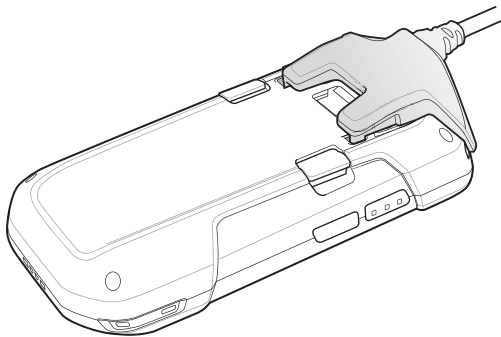

Figure 7-42 *Cable Attached to TC75*

DEX Communication

1. Connect the Snap-On DEX Cable to the TC75.
2. Connect the DEX connector of the cable to a device such as a vending machine.

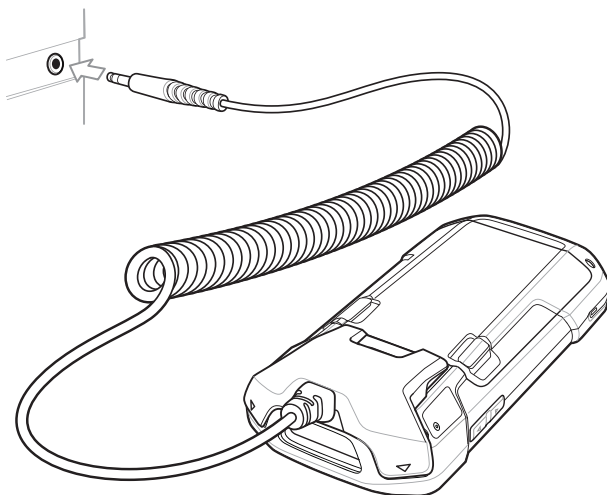

Figure 7-43 *DEX Cable Connection*

Disconnecting from TC75

1. Press down on the cable.

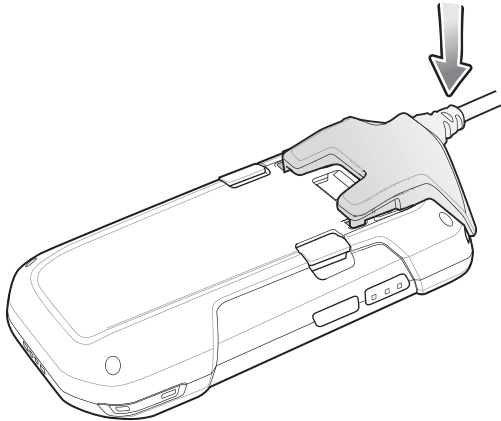

Figure 7-44 *Press Down on Cable*

2. Rotate away from the TC75. The magnetics release the cable from the TC75.

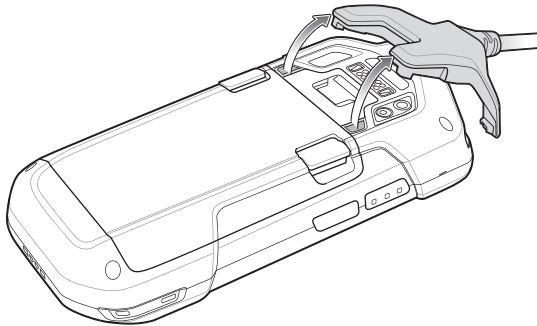

Figure 7-45 *Remove Cable from TC75*

Trigger Handle

The Trigger Handle adds a gun-style handle with a scanning trigger to the device. It increases comfort when using the device in scan-intensive applications for extended periods of time.

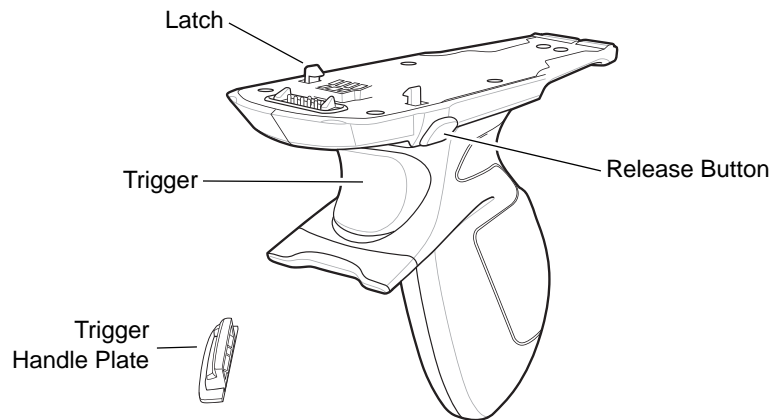

Figure 7-46 *Trigger Handle*

Installing the Trigger Handle Plate

1. Press and hold the **Power** button until the menu appears.
2. Touch **Power off**.
3. Touch **OK**.
4. Press in the two battery latches.
5. Lift the battery from the device.
6. Remove the hand strap filler plate from the hand strap slot. Store the hand strap filler plate in a safe place for future replacement.

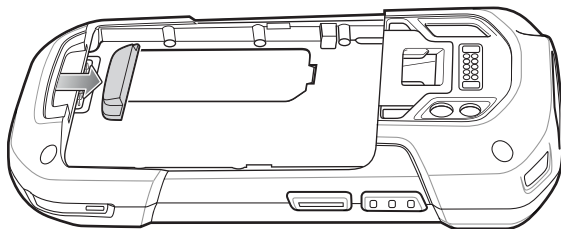

Figure 7-47 *Remove Hand Strap Plate*

7. Insert the replacement hand strap plate into the hand strap slot.

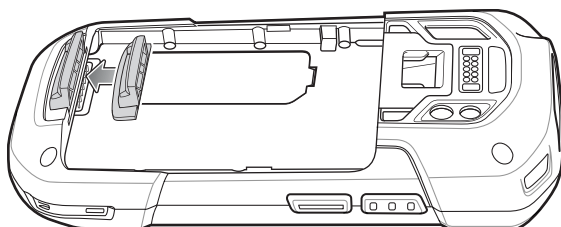

Figure 7-48 *Insert Trigger Handle Plate*

8. Insert the battery, bottom first, into the battery compartment in the back of the device.
9. Rotate the top of the battery into the battery compartment.
10. Press the battery down into the battery compartment until the battery release latches snap into place.

Inserting the Device into the Trigger Handle

1. Align the back of the Trigger handle with the Trigger Mounting Plate.

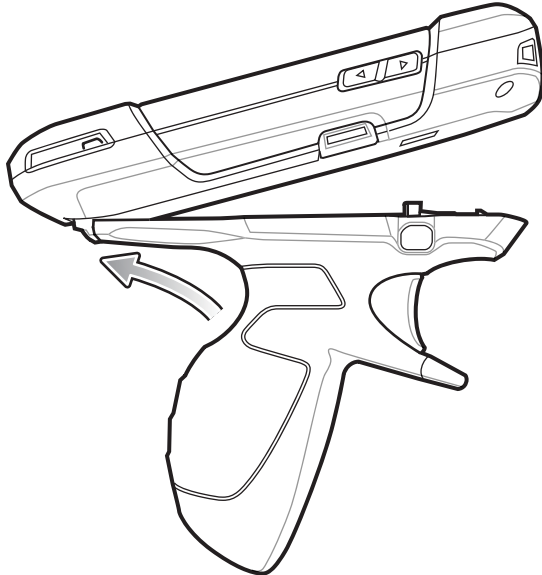

Figure 7-49 *Connect Device to Trigger Handle*

2. Press the two release latches.
3. Rotate the device down and press down until it snaps into place.

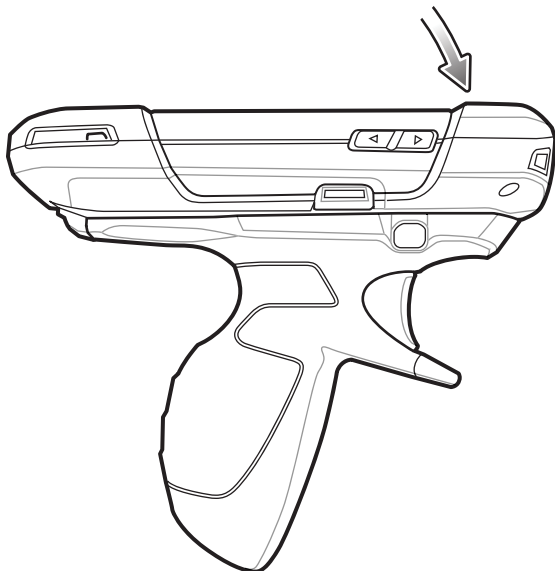

Figure 7-50 *Rotate Device onto Trigger Handle*

Removing the Device from the Trigger Handle

1. Press both Trigger Handle release latches.

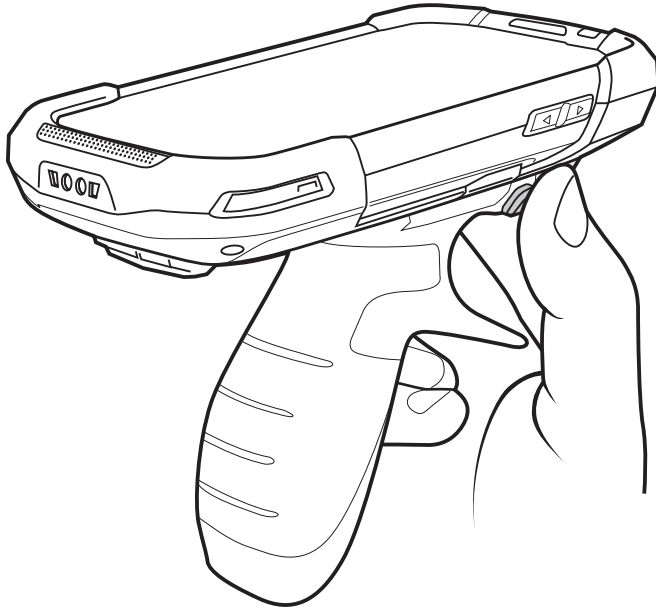

Figure 7-51 *Press Release Latches*

2. Rotate the device up and remove from the Trigger handle.
3. Rotate the device down and press down until it snaps into place.

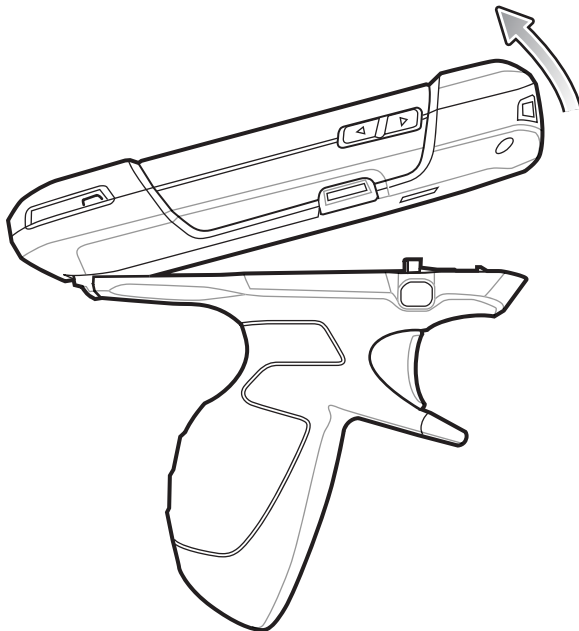

Figure 7-52 *Rotate Device onto Trigger Handle*

Vehicle Charging Cable Cup

This section describes how to use the Vehicle Charging Cable Cup to charge the TC75.

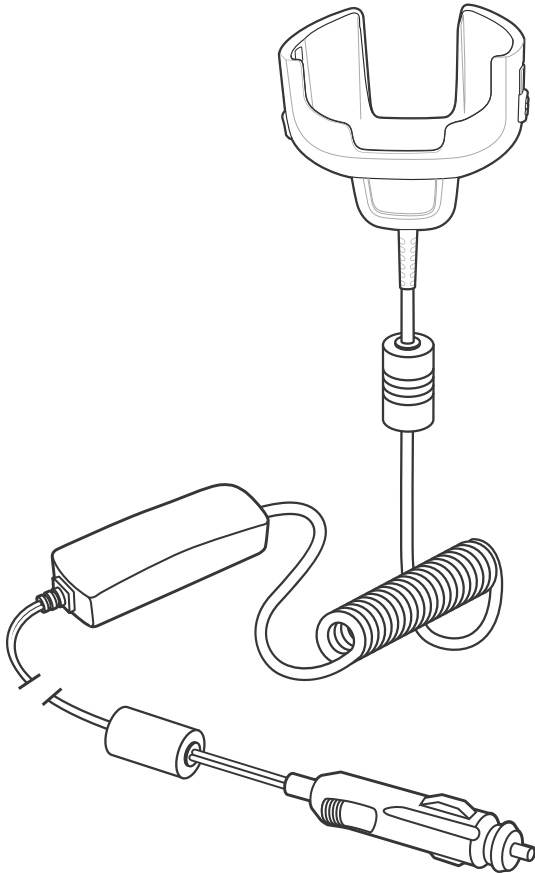

Figure 7-53 *Vehicle Charging Cable Cup*

Charging the TC75

1. Insert the TC75 into the cup of the Vehicle Charging Cable.

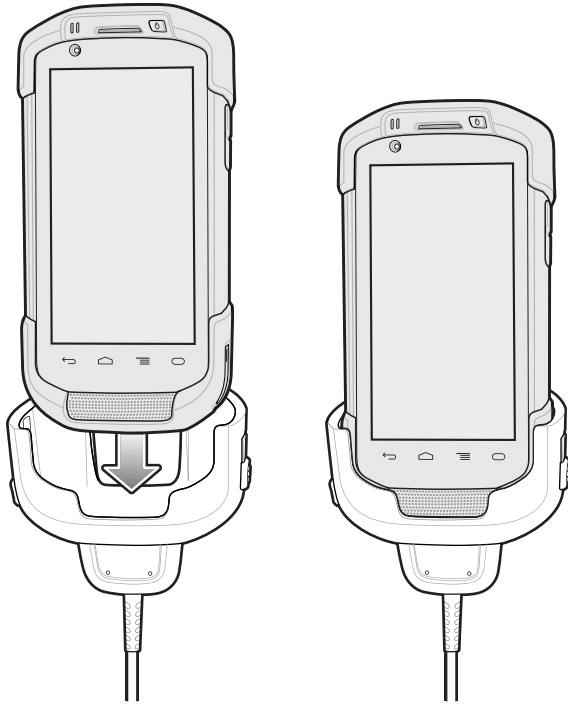

Figure 7-54 *TC75 Charging*

2. Ensure the TC75 is seated properly.
3. Slide the two yellow locking tabs up to lock the cable to the TC75.

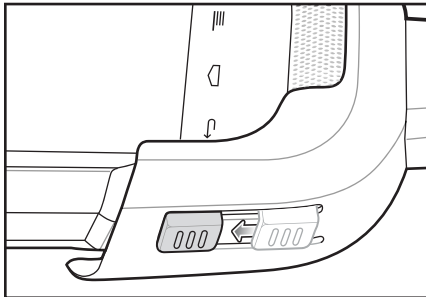

Figure 7-55 *Lock Cable Cup*

4. Insert the Cigarette Lighter plug into the vehicle cigarette lighter socket.

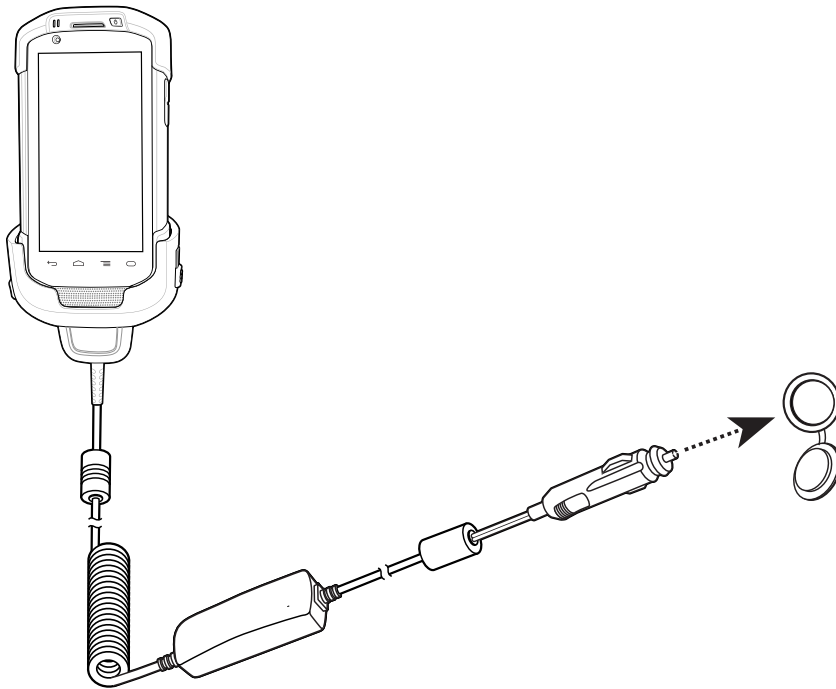

Figure 7-56 *Connect Cable to Vehicle Power Source*

Battery Charging

Main Battery Charging

The device's Charging/Notification LED indicates the status of the battery charging in the device.

The 4,620 mAh battery fully charges in less than six hours at room temperature.

Charging Temperature

Charge batteries in temperatures from 0 °C to 40 °C (32 °F to 104 °F). The device always performs battery charging in a safe and intelligent manner. At higher temperatures (e.g. approximately +37 °C (+98 °F)) the device may for small periods of time alternately enable and disable battery charging to keep the battery at acceptable temperatures. The device indicates when charging is disabled due to abnormal temperatures via its LED.

Vehicle Cradle

Refer to the *TC75 Integrator Guide* for information on installing the Vehicle Cradle.

The cradle:

- holds the TC75 securely in place
- provides power for operating the TC75
- re-charges the battery in the TC75.

The cradle is powered by the vehicle's 12V or 24V electrical system. The operating voltage range is 9V to 32V and supplies a maximum current of 3A.

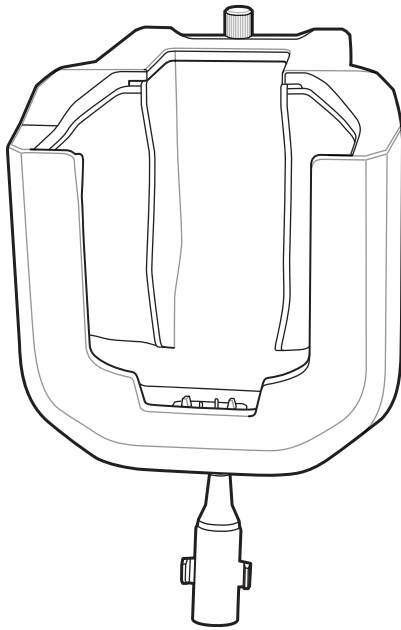

Figure 7-57 *Vehicle Cradle*

TC75 Insertion and Removal



CAUTION Ensure that the TC75 is fully inserted into the cradle. Lack of proper insertion may result in property damage or personal injury. Zebra Technologies Corporation is not responsible for any loss resulting from the use of the products while driving.

To ensure the TC75 was inserted correctly, listen for the audible click that signifies that the TC75 locking mechanism was enabled and the TC75 was locked into place.

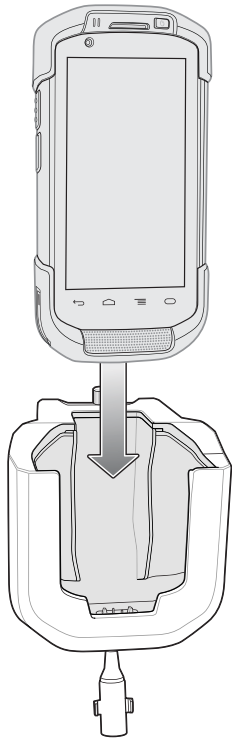

Figure 7-58 *Install TC75 into Vehicle Cradle*

To remove the TC75 from the cradle, grasp the TC75 and lift out of the cradle.

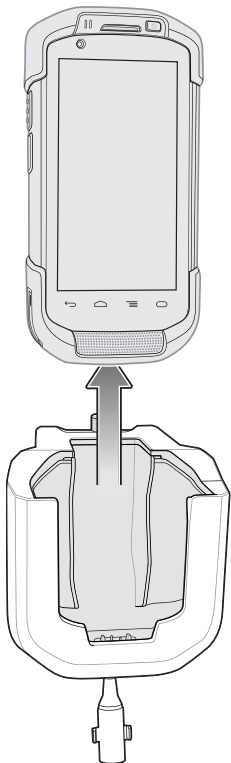

Figure 7-59 *Remove TC75 from Vehicle Cradle*

Battery Charging

Ensure the cradle is connected to a power source.

Insert the TC75 into the cradle. The TC75 starts to charge through the cradle as soon as it is inserted. This does not deplete the vehicle battery significantly. The battery charges in approximately four hours.

- ✓ **NOTE** The Vehicle Cradle operating temperature is -40 °C to +85 °C. When in the cradle, the TC75 will only charge when its temperature is between 0 °C to +40 °C.

Table 7-9 LED Indicators

LED	Indication
TC75 Battery Charging (LED is on TC75)	
Off	TC75 is not in cradle, TC75 is not placed correctly, or cradle is not powered.
Fast Blinking Red (twice a second)	Error in charging (not within battery charging temperature or charging for too long without completion). Check placement of TC75.
Slow Blinking Amber (once every two seconds)	TC75 is charging.
Solid Green	Charging is complete.

CHAPTER 8 MAINTENANCE AND TROUBLESHOOTING

Introduction

This chapter includes instructions on cleaning and storing the device, and provides troubleshooting solutions for potential problems during operation.

Maintaining the TC75

For trouble-free service, observe the following tips when using the TC75:

- Do not scratch the screen of the TC75. When working with the TC75, use the supplied stylus or plastic-tipped pens intended for use with a touch-sensitive screen. Never use an actual pen or pencil or other sharp object on the surface of the TC75 screen.
- The touch-sensitive screen of the TC75 is glass. Do not drop the TC75 or subject it to strong impact.
- Protect the TC75 from temperature extremes. Do not leave it on the dashboard of a car on a hot day, and keep it away from heat sources.
- Do not store or use the TC75 in any location that is dusty, damp, or wet.
- Use a soft lens cloth to clean the TC75. If the surface of the TC75 screen becomes soiled, clean it with a soft cloth moistened with a diluted window-cleaning solution.
- Periodically replace the rechargeable battery to ensure maximum battery life and product performance. Battery life depends on individual usage patterns.

Battery Safety Guidelines

- The area in which the units are charged should be clear of debris and combustible materials or chemicals. Particular care should be taken where the device is charged in a non commercial environment.
- Follow battery usage, storage, and charging guidelines found in this guide.
- Improper battery use may result in a fire, explosion, or other hazard.
- To charge the mobile device battery, the battery and charger temperatures must be between +32°F and +104°F (0°C and +40°C)

- Do not use incompatible batteries and chargers. Use of an incompatible battery or charger may present a risk of fire, explosion, leakage, or other hazard. If you have any questions about the compatibility of a battery or a charger, contact the Global Customer Support Center.
- For devices that utilize a USB port as a charging source, the device shall only be connected to products that bear the USB-IF logo or have completed the USB-IF compliance program.
- Do not disassemble or open, crush, bend or deform, puncture, or shred.
- Severe impact from dropping any battery-operated device on a hard surface could cause the battery to overheat.
- Do not short circuit a battery or allow metallic or conductive objects to contact the battery terminals.
- Do not modify or remanufacture, attempt to insert foreign objects into the battery, immerse or expose to water or other liquids, or expose to fire, explosion, or other hazard.
- Do not leave or store the equipment in or near areas that might get very hot, such as in a parked vehicle or near a radiator or other heat source. Do not place battery into a microwave oven or dryer.
- Battery usage by children should be supervised.
- Please follow local regulations to properly dispose of used re-chargeable batteries.
- Do not dispose of batteries in fire.
- In the event of a battery leak, do not allow the liquid to come in contact with the skin or eyes. If contact has been made, wash the affected area with large amounts of water and seek medical advice.
- If you suspect damage to your equipment or battery, contact the Customer Support to arrange for inspection.

Cleaning Instructions



CAUTION Always wear eye protection.

Read warning label on compressed air and alcohol product before using.

If you have to use any other solution for medical reasons please contact the Global Customer Support Center for more information.



WARNING! Avoid exposing this product to contact with hot oil or other flammable liquids. If such exposure occurs, unplug the device and clean the product immediately in accordance with these guidelines.

Approved Cleanser Active Ingredients

100% of the active ingredients in any cleaner must consist of one or some combination of the following: isopropyl alcohol, bleach/sodium hypochlorite¹(see Important note below), hydrogen peroxide or mild dish soap.



IMPORTANT Use pre-moistened wipes and do not allow liquid to pool.

¹ When using sodium hypochlorite (bleach) based products always follow the manufacturer's recommended instructions: use gloves during application and remove the residue afterwards with a damp alcohol cloth or a cotton swab to avoid prolonged skin contact while handling the device.

Due to the powerful oxidizing nature of sodium hypochlorite, the metal surfaces on the device are prone to oxidization (corrosion) when exposed to this chemical in the liquid form (including wipes). Avoid allowing any bleach based product to come in contact with the metal electrical contacts on the device, the battery, or the cradle. In the event that these types of disinfectants come in contact with metal on the device, prompt removal with alcohol-dampened cloth or cotton swab after the cleaning step is critical.

Harmful Ingredients

The following chemicals are known to damage the plastics on the device and should not come in contact with the device: ammonia solutions, compounds of amines or ammonia; acetone; ketones; ethers; aromatic and chlorinated hydrocarbons; aqueous or alcoholic alkaline solutions; ethanolamine; toluene; trichloroethylene; benzene; carboric acid and TB-lysoform.

Cleaning Instructions

Do not apply liquid directly to the device. Dampen a soft cloth or use pre-moistened wipes. Do not wrap the device in the cloth or wipe, but gently wipe the unit. Be careful not to let liquid pool around the display window or other places. Allow the unit to air dry before use.

Special Cleaning Notes

Many vinyl gloves contain phthalate additives, which are often not recommended for medical use and are known to be harmful to the housing of the device. The device should not be handled while wearing vinyl gloves containing phthalates, or before hands are washed to remove contaminant residue after gloves are removed. If products containing any of the harmful ingredients listed above are used prior to handling the device, such as hand sanitizer that contain ethanolamine, hands must be completely dry before handling the device to prevent damage to the plastics.

Cleaning Materials Required

- Alcohol wipes
- Lens tissue
- Cotton-tipped applicators
- Isopropyl alcohol
- Can of compressed air with a tube.

Cleaning Frequency

The cleaning frequency is up to the customer's discretion due to the varied environments in which the mobile devices are used. They may be cleaned as frequently as required, but it is advisable to clean the camera window periodically when used in dirty environments to ensure optimum performance.

Cleaning the TC75

Housing

Using the alcohol wipes, wipe the housing including buttons.

Display

The display can be wiped down with the alcohol wipes, but care should be taken not to allow any pooling of liquid around the edges of the display. Immediately dry the display with a soft, non-abrasive cloth to prevent streaking.

Camera and Exit Window

Wipe the camera and exit window periodically with a lens tissue or other material suitable for cleaning optical material such as eyeglasses.

Connector Cleaning

To clean the connectors:

1. Remove the main battery from mobile computer.
2. Dip the cotton portion of the cotton-tipped applicator in isopropyl alcohol.
3. Rub the cotton portion of the cotton-tipped applicator back-and-forth across the connector. Do not leave any cotton residue on the connector.
4. Repeat at least three times.
5. Use the cotton-tipped applicator dipped in alcohol to remove any grease and dirt near the connector area.
6. Use a dry cotton-tipped applicator and repeat steps 4 through 6.



CAUTION Do not point nozzle at yourself and others, ensure the nozzle or tube is away from your face.

7. Spray compressed air on the connector area by pointing the tube/nozzle about ½ inch away from the surface.
8. Inspect the area for any grease or dirt, repeat if required.

Cleaning Cradle Connectors

To clean the connectors on a cradle:

1. Remove the DC power cable from the cradle.
2. Dip the cotton portion of the cotton-tipped applicator in isopropyl alcohol.
3. Rub the cotton portion of the cotton-tipped applicator along the pins of the connector. Slowly move the applicator back-and-forth from one side of the connector to the other. Do not leave any cotton residue on the connector.
4. All sides of the connector should also be rubbed with the cotton-tipped applicator.



CAUTION Do not point nozzle at yourself and others, ensure the nozzle or tube is pointed away from your face.

5. Spray compressed air in the connector area by pointing the tube/nozzle about ½ inch away from the surface.
6. Remove any lint left by the cotton-tipped applicator.
7. If grease and other dirt can be found on other areas of the cradle, use a lint-free cloth and alcohol to remove.
8. Allow at least 10 to 30 minutes (depending on ambient temperature and humidity) for the alcohol to air dry before applying power to cradle.

If the temperature is low and humidity is high, longer drying time is required. Warm temperature and dry humidity requires less drying time.

Troubleshooting

The following tables provides typical problems that might arise and the solution for correcting the problem.

TC75

Table 8-1 *Troubleshooting the TC75*

Problem	Cause	Solution
When pressing the power button the TC75 does not turn on.	Battery not charged.	Charge or replace the battery in the TC75.
	Battery not installed properly.	Install the battery properly.
	System crash.	Perform a reset.
When pressing the power button the TC75 does not turn on but two LEDs blink.	Battery charge is at a level where data is maintained but battery should be re-charged.	Charge or replace the battery in the TC75.
Battery did not charge.	Battery failed.	Replace battery. If the TC75 still does not operate, perform a reset.
	TC75 removed from cradle while battery was charging.	Insert TC75 in cradle. The 4,620 mAh battery fully charges in less than six hours at room temperature.
	Extreme battery temperature.	Battery does not charge if ambient temperature is below 0°C (32°F) or above 40°C (104°F).
Cannot see characters on display.	TC75 not powered on.	Press the Power button.
During data communication with a host computer, no data transmitted, or transmitted data was incomplete.	TC75 removed from cradle or disconnected from host computer during communication.	Replace the TC75 in the cradle, or reattach the communication cable and re-transmit.
	Incorrect cable configuration.	See the system administrator.
	Communication software was incorrectly installed or configured.	Perform setup.
During data communication over Wi-Fi, no data transmitted, or transmitted data was incomplete.	Wi-Fi radio is not on.	Turn on the Wi-Fi radio.
	You moved out of range of an access point.	Move closer to an access point.

Table 8-1 Troubleshooting the TC75 (Continued)



Problem	Cause	Solution
During data communication over WAN, no data transmitted, or transmitted data was incomplete.	You are in an area of poor cellular service.	Move into an area that has better service.
	APN is not set up correctly.	See system administrator for APN setup information.
	SIM card not installed properly.	Remove and re-install the SIM card.
	Data plan not activated.	Contact your service provider and ensure that your data plan is enable.
During data communication over Bluetooth, no data transmitted, or transmitted data was incomplete.	Bluetooth radio is not on.	Turn on the Bluetooth radio.
	You moved out of range of another Bluetooth device.	Move within 10 meters (32.8 feet) of the other device.
No sound.	Volume setting is low or turned off.	Adjust the volume.
TC75 shuts off.	TC75 is inactive.	The display turns off after a period of inactivity. Set this period to 15 seconds, 30 seconds, 1, 2, 5, 10 or 30 minutes.
	Battery is depleted.	Replace the battery.
Tapping the window buttons or icons does not activate the corresponding feature.	The device is not responding.	Reset the device.
A message appears stating that the TC75 memory is full.	Too many files stored on the TC75.	Delete unused memos and records. If necessary, save these records on the host computer (or use an SD card for additional memory).
	Too many applications installed on the TC75.	Remove user-installed applications on the TC75 to recover memory. Select  >  Apps > Downloaded . Select the unused program and tap Remove .

Table 8-1 *Troubleshooting the TC75 (Continued)*

Problem	Cause	Solution
The TC75 does not decode with reading bar code.	Scanning application is not loaded.	Load a scanning application on the TC75 or enable DataWedge. See the system administrator.
	Unreadable bar code.	Ensure the symbol is not defaced.
	Distance between exit window and bar code is incorrect.	Place the TC75 within proper scanning range.
	TC75 is not programmed for the bar code.	Program the TC75 to accept the type of bar code being scanned. Refer to the EMDK or DataWedge application.
	TC75 is not programmed to generate a beep.	If the TC75 does not beep on a good decode, set the application to generate a beep on good decode.
	Battery is low.	If the scanner stops emitting a laser beam upon a trigger press, check the battery level. When the battery is low, the scanner shuts off before the TC75 low battery condition notification. Note: If the scanner is still not reading symbols, contact the distributor or the Global Customer Support Center.
TC75 cannot find any Bluetooth devices nearby.	Too far from other Bluetooth devices.	Move closer to the other Bluetooth device(s), within a range of 10 meters (32.8 feet).
	The Bluetooth device(s) nearby are not turned on.	Turn on the Bluetooth device(s) to find.
	The Bluetooth device(s) are not in discoverable mode.	Set the Bluetooth device(s) to discoverable mode. If needed, refer to the device's user documentation for help.
Cannot unlock TC75.	User enters incorrect password.	If the user enters an incorrect password eight times, the user is requested to enter a code before trying again. If the user forgot the password, contact system administrator.

APPENDIX A TECHNICAL SPECIFICATIONS

Introduction

This chapter provides technical specification for the device.

TC75

Table A-1 *TC75 Technical Specifications*

Item	Description
Physical Characteristics	
Dimensions	Height: 161 mm (6.3 in.) Width: 84 mm (3.3 in.) Depth: 28 mm (1.1 in.)
Weight	376 g (13.3 oz)
Display	4.7 in. High Definition (1280 x 720); exceptionally bright image; optically bonded to touch panel with Gorilla Glass™ protection
Touch Panel	Capacitive touch
Backlight	Light Emitting Diode (LED) backlight
Battery Pack	Rechargeable Lithium Ion 3.7V, 4,620 mAh battery
Expansion Slot	User accessible microSD up to 32 GB SDHC and up to 64 GB SDXC support (FAT32 format only)
Connection Interface	Universal Serial Bus (USB) 2.0 High Speed (host and client)
Notification	Audible tone plus multi-color LEDs, vibration
Voice and Audio	Three microphone support with noise cancellation; vibrate alert; speaker; Bluetooth wireless headset support. High quality speaker phone with up to 108 db SPL volume; PTT headset support; Cellular circuit switch voice; HD Voice

Table A-1 TC75 Technical Specifications (Continued)

Item	Description
Performance Characteristics	
CPU	1.7 GHz dual-core.
Operating System	Android-based AOSP and GMS V5.1.1
Memory	1 GB RAM/8 GB Flash
User Environment	
Operating Temperature	-20 °C to 50 °C (-4 °F to 122 °F)
Storage Temperature	-40°C to 70°C (-40°F to 158°F)
Charging Temperature	0° C to 40° C (32°F to 104°F)
Humidity	5 to 85% non-condensing
Drop Specification	8 ft./2.4 m to concrete at room temperature; 6 ft./1.8 m over the operating temperature range
Tumble	2,000 3.2 ft./1.0 m tumbles; meets and exceeds IEC tumble specifications
Electrostatic Discharge (ESD)	+/-15kVdc air discharge, +/-8kVdc direct discharge, +/-8kVdc indirect discharge
Sealing	IP67 per applicable IEC sealing specifications
Vibration	4 g's PK Sine (5 Hz to 2 kHz); 0.04g2/Hz Random (20 Hz to 2 kHz); 60 minute duration per axis, 3 axis
Thermal Shock	-40° C to 70° C (-40° F to 158° F) rapid transition
Interactive Sensor Technology (IST)	
Motion Sensor	3-axis accelerometer provides motion-sensing for dynamic screen orientation and power management
Light Sensor	Ambient light sensor to auto adjust display backlight brightness
Wireless WAN Data and Voice Communications	
Frequency band	Worldwide: LTE: 800/850/900/1800/2100/2600 (FDD 20,5,8,3,1,7) UMTS/HSPA/HSPA+: 850/900/1900/2100 GSM/GPRS/EDGE: 850/900/1800/1900 Americas: LTE: 700/850/1900/AWS/2100 (FDD 17,5,2,4,1) UMTS/HSPA/HSPA+: 850, 900, AWS, 1900, 2100 GSM/GPRS/EDGE: 850/900/1800/1900
GPS	Integrated, Autonomous, Assisted GPS (A-GPS), Navstar, GLONASS
Wireless LAN Data and Voice Communications	
Radio	IEEE® 802.11a/b/g/n/d/h/i/k/r

Table A-1 TC75 Technical Specifications (Continued)

Item	Description
Data Rates Supported	5GHz: 802.11a/n - up to 150 Mbps 2.4GHz: 802.11b/g/n - up to 72.2 Mbps
Operating Channels	5 GHz: Chan 36 - 165 (5180 - 5825 MHz) 2.4 GHz: Chan 1 - 11 (2412 – 2462 MHz) – North America (FCC and IC) Chan 1 - 13 (2412 - 2472 MHz) – Rest of the World Actual operating channels/frequencies depend on regulatory rules and certification agency
Security	Security Modes: Legacy, WPA and WPA2 Encryption: WEP (40 and 104 bit), TKIP and AES Authentication: TLS, TTLS (MS-CHAP), TTLS (MS-CHAP v2), TTLS (PAP), PEAP (MS-CHAP v2), PEAP (GTC), FAST (MS-CHAP v2), FAST (GTC), LEAP. Fast Roam: PMKID, OKC, CCKM
Voice Communications	Voice-over-IP ready, Wi-Fi™-certified, IEEE 802.11a/b/g/n direct sequence wireless LAN, Wi-Fi Multimedia™ (WMM)
Wireless PAN Data and Voice Communications	
Bluetooth	Bluetooth v4.0 Low Energy
Data Capture Specifications	
2D Imager	SE4750-SR – 1D and 2D bar codes.
Near Field Communications (NFC)	ISO 14443 Type A & B, FeliCa, and ISO 15963 cards. Secure NFC via SAM supporting Mifare, Calypso and FeliCa. P2P mode and Card Emulation via UICC and Host.
Communication and Messaging	
Workforce Connect PTT Express (included) for instant PTT calls between workers inside the four walls; Workforce Connect PTT Pro (supported) for PTT calls and text messaging over Wi-Fi and cellular networks; Workforce Connect Voice client (supported) to enable PBX handset functionality and more inside the four walls.	
2D Imager Engine (SE4750-SR) Specifications	
Field of View	Horizontal - 48.0° Vertical - 36.7°
Image Resolution	1280 horizontal X 960 vertical pixels
Roll	360°
Pitch Angle	+/- 60° from normal
Skew Tolerance	+/- 60° from normal
Ambient Light	Sunlight: 10,000 ft. candles (107,639 lux)
Focal Distance	From front of engine: 17.7 cm (7.0 in.)

Table A-1 TC75 Technical Specifications (Continued)

Item	Description
Laser Aiming Element	Visible Laser Diode (VLD): 655 nm +/- 10 nm Central Dot Optical Power: 0.6 mW (typical) Pattern Angle: 48.0° horizontal, 38.0° vertical
Illumination System	LEDs: Warm white LED Pattern Angle: 80° at 505 intensity
Camera Specifications	
Resolution	Rear: 8 Mega pixel auto focus with flash Front: 1.3 Mega pixel fixed focus

Table A-2 Data Capture Supported Symbologies

Item	Description
1D Bar Codes	GS1 DataBar Expanded, GS1 128, GS1 DataBar Coupon, Interleaved 2 of 5, UPC Coupon Code, Bookland EAN, Bookland ISBN, Codabar, Code 11, Code 128, Code 39, Code 32, Code 93, Chinese 2 of 5, Discrete 2 of 5 (DTF), EAN-8, EAN-13, ISSN EAN Code 128, Matrix 2 of 5, MSI, UPC-A, UCC Coupon Extended Code, UPC-E, UPC-E1
2D Bar Codes	PDF-417, QR Code

INDEX

A

adaptive frequency hopping	6-17
adjust volume	3-2
airplane mode	1-17
albums	4-18
application shortcuts	2-8
applock administrator	2-15
approved cleanser	8-2
audio modes	3-1

B

battery usage	1-16
Bluetooth	
PIN	6-17
security	6-17
bluetooth	6-16
Bluetooth call	3-12
Bluetooth headset	3-1
browser	2-12

C

calculator	2-12
calendar	2-12
call barring	3-16
call forwarding	3-16
call waiting	3-16
caller ID	3-16
camera	2-12
camera settings	4-13
cleaning	8-2
cleaning instructions	8-3
clock	2-12
conference call	3-9
cradle	

connector cleaning	8-4
--------------------	-----

D

data capture options	1-ii
datawedge	2-12, 5-8
diagnostics	4-41
digital camera	5-2
display	1-ii
cleaning	8-4
downloads	2-12
DTMF tones	3-15
DWDEmo	2-12

E

EAP	6-7
Elemex	4-41
email	2-13
emergency calling	3-1
Ethernet connection	7-20

F

file browser	2-13, 4-3
finger usage	1-20
fixed dialing numbers	3-15
Flash	1-ii
font size	1-19

G

gallery	2-13
---------	------

H

handset mode	3-1
--------------	-----

Index - 2 TC75 User Guide

harmful ingredients 8-3
headset mode 3-1

I

imager 1-ii
internet calling 3-16

K

keyboard 2-11

L

low battery notification 1-17

M

memory 1-ii
messaging 2-13
multiuser administrator 2-15

N

naming folders 2-9

O

operating system 1-ii

P

panoramic 4-10
photos 4-8

R

radios 1-ii
RAM 1-ii
recording videos 4-11
resetting 2-22
ringtone 3-15
RS507 scanning 5-5

S

screen font size 1-19
screen lock sound 1-24
screen rotation 1-18
screen touch notification 1-24
secure storage administrator 2-15
sensors A-2
setting

camera 4-13
video 4-15
settings 2-14
SMS 2-13
soft reset 2-22
software version 1-ii
sound recordet 2-14
speaker mode 3-1
status bar 2-3
system notification 1-24

T

taking a panoramic photo 4-10
touch mode 1-20
troubleshooting 8-6
TTY 3-15

U

user guide 2-15
using a Bluetooth headset 3-1
using a wired headset 3-2

V

video settings 4-15
videos 4-8, 4-11
voicemail setup 3-15

W

WEP 6-7
wired headset 3-2
WPA 6-7



Zebra Technologies Corporation, Inc.
3 Overlook Point
Lincolnshire, IL 60069, U.S.A.
<http://www.zebra.com>

© 2018 ZIH Corp and/or its affiliates. All rights reserved. ZEBRA and the stylized Zebra head are trademarks of ZIH Corp, registered in many jurisdictions worldwide. Google, Google Play and other marks are trademarks of Google Inc. All other trademarks are the property of their respective owners.