

RS6000

Ring Scanner

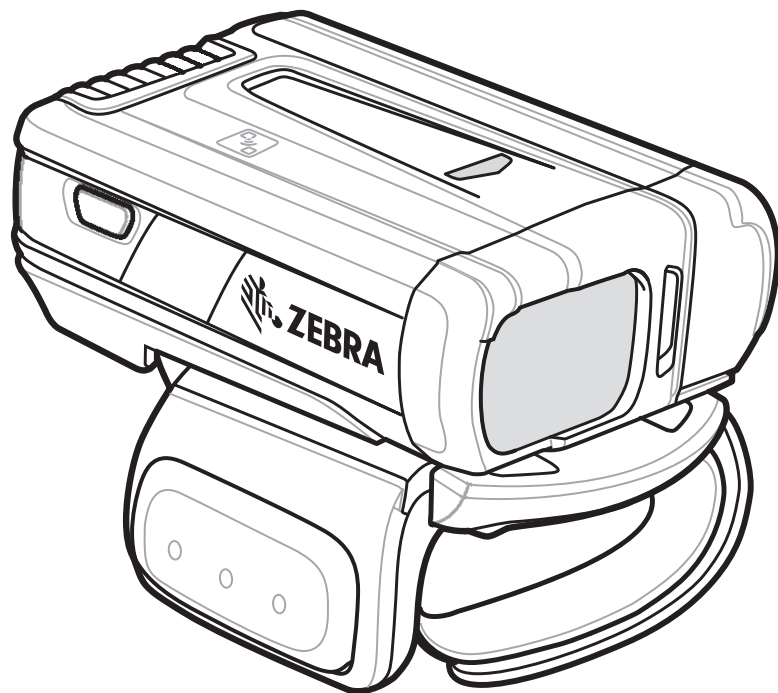

User Guide

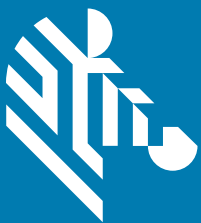

ZEBRA

Copyright

© 2018 ZIH Corp. and/or its affiliates. All rights reserved. ZEBRA and the stylized Zebra head are trademarks of ZIH Corp., registered in many jurisdictions worldwide. All other trademarks are the property of their respective owners.

COPYRIGHTS & TRADEMARKS: For complete copyright and trademark information, go to www.zebra.com/copyright.

WARRANTY: For complete warranty information, go to www.zebra.com/warranty.

END USER LICENSE AGREEMENT: For complete EULA information, go to www.zebra.com/eula.

Terms of Use

- Proprietary Statement

This manual contains proprietary information of Zebra Technologies Corporation and its subsidiaries (“Zebra Technologies”). It is intended solely for the information and use of parties operating and maintaining the equipment described herein. Such proprietary information may not be used, reproduced, or disclosed to any other parties for any other purpose without the express, written permission of Zebra Technologies.

- Product Improvements

Continuous improvement of products is a policy of Zebra Technologies. All specifications and designs are subject to change without notice.

- Liability Disclaimer

Zebra Technologies takes steps to ensure that its published Engineering specifications and manuals are correct; however, errors do occur. Zebra Technologies reserves the right to correct any such errors and disclaims liability resulting therefrom.

- Limitation of Liability

In no event shall Zebra Technologies or anyone else involved in the creation, production, or delivery of the accompanying product (including hardware and software) be liable for any damages whatsoever (including, without limitation, consequential damages including loss of business profits, business interruption, or loss of business information) arising out of the use of, the results of use of, or inability to use such product, even if Zebra Technologies has been advised of the possibility of such damages. Some jurisdictions do not allow the exclusion or limitation of incidental or consequential damages, so the above limitation or exclusion may not apply to you.

Revision History

Changes to the original guide are listed below:

Change	Date	Description
-01	05/16	Initial Release
-02	07/17	Updates to: Radio communication parameters User preference parameters 123Scan and software tools.

Change	Date	Description
-03	10/17	Illustrations updated to reflect hardware changes.
-04	10/18	Add information for the new Trigger Assembly with Cam Buckle.

Table of Contents

Copyright	2
Terms of Use	2
Revision History	2

About This Guide

Introduction	13
Documentation Set	13
Model Configurations	14
Chapter Descriptions	14
Notational Conventions	15
Related Documents	15
Service Information	16
Provide Documentation Feedback	16

Getting Started

Introduction	17
Unpacking	17
Configuration Features	18
Status Indications	19
RS6000 Activity Modes	20
Configuration	21
Trigger Swivel Assembly - Change Trigger Position	21
Charge the Battery	21
Install the Battery	21
Remove the Battery	22
Wearing the RS6000	22
Bluetooth Connection	23
Scanning	23
Scan Triggering Modes	23
Aiming the RS6000	24
Resetting the RS6000	25
Warm Boot	25
Cold Boot	25
Clean Boot	25

Bluetooth Communications

Introduction	27
Scanning Sequence Examples	27
Errors While Scanning	27
Bluetooth Communications Parameter Defaults	28
Bluetooth Status Indications	29
Bluetooth Connection Modes	29
Keyboard Emulation	29
HID Bluetooth Classic	30
HID Bluetooth Low Energy (Discoverable)	30
HID Setup	30
HID Options	34
Simple Serial Interface	41
SSI Setup	41
Serial Port Profile	44
SPP Setup	44
General Bluetooth Options	57
Discoverable Mode	57
Bluetooth Security	58
Wi-Fi Friendly Mode	61
Radio Output Power	64
Link Supervision Timeout	65
Reconnecting	66
Bluetooth Disconnection Alert Control	71
Pairing Support	76
Batch Mode	79

Accessories

Accessories	81
1-Slot RS6000 USB Charging Cradle	84
Charging the RS6000	85
Charging the Spare Battery	85
Battery Charging	86
2-Slot WT6000/RS6000 USB Charging Cradle	87
Charging the WT6000	88
Charging the RS6000	88
Battery Charging	89
5-Slot RS6000 Charge Only Cradle	90
Charging the RS6000	91
Charging the Spare Battery	91
Battery Charging	92
10-Slot WT6000/RS6000 Charge Only Cradle	93
Charging the WT6000	94
Charging the RS6000	95
Battery Charging	95
10-Slot RS6000 Charge Only Cradle	96
Charging the RS6000	97
Battery Charging	97
4-Slot Battery Charger	98
Battery Installation	98

Battery Removal	99
Battery Charging	99
20-Slot Battery Charger	100
Battery Installation	101
Battery Removal	101
Battery Charging	101
RS6000 Configuration and Update	
Introduction	102
Configuring the RS6000	102
Introduction	102
DataWedge	102
123Scan2	103
Real Time Logger	103
Retrieving the RS6000 Log File	103
RS6000 Firmware Update	104
Direct USB using 123Scan2	105
Bluetooth connected WT6000	105
Configuring Motion and Proximity	
Introduction	106
Operation Modes	106
Configuring Motion and Proximity	108
Motion Sensing Control	108
Motion Sensitivity	108
Proximity Sensing Control	109
Proximity Continuous Enable	109
Proximity Distance	110
Good Scan Indication Delay Control	111
Miscellaneous Imager Options	
Introduction	113
Scanning Sequence Examples	114
Errors While Scanning	114
User Preferences/Miscellaneous Options Parameter Defaults	114
User Preferences	116
Default Parameters	116
Parameter Bar Code Scanning	117
Beep After Good Decode	118
Beep on Insertion	118
Beeper Volume	119
Beeper Tone	120
Beeper Duration	121
Suppress Power Up Beeps	121
Low Battery Indication	122
Hand-Held Trigger Mode	123
Hand-Held Decode Aiming Pattern	124
Picklist Mode	125

Table of Contents

FIPS Mode	126
Continuous Bar Code Read	127
Unique Bar Code Reporting	127
Decode Session Timeout	128
Timeout Between Decodes, Same Symbol	129
Timeout Between Decodes, Different Symbol	130
Fuzzy 1D Processing	130
Decode Mirror Images (Data Matrix Only)	131
Mobile Phone/Display Mode	132
PDF Prioritization	133
PDF Prioritization Timeout	134
Decoding Illumination	134
Motion Tolerance	135
Miscellaneous Scanner Parameters	135
Add an Enter Key	135
Transmit Code ID Character	135
Prefix/Suffix Values	136
Scan Data Transmission Format	137
FN1 Substitution Values	139
Transmit “No Read” Message	140

Symbologies

Introduction	141
Scanning Sequence Examples	141
Errors While Scanning	141
Symbology Parameter Defaults	142
Enable/Disable All Code Types	148
UPC/EAN	149
Enable/Disable UPC-A	149
Enable/Disable UPC-E	149
Enable/Disable UPC-E1	150
Enable/Disable EAN-8/JAN-8	150
Enable/Disable EAN-13/JAN-13	151
Enable/Disable Bookland EAN	151
Decode UPC/EAN/JAN Supplementals	152
User-Programmable Supplementals	155
UPC/EAN/JAN Supplemental Redundancy	155
UPC/EAN/JAN Supplemental AIM ID Format	156
UPC Reduced Quiet Zone	157
Transmit UPC-A Check Digit	157
Transmit UPC-E Check Digit	158
Transmit UPC-E1 Check Digit	158
UPC-A Preamble	159
UPC-E Preamble	160
UPC-E1 Preamble	161
Convert UPC-E to UPC-A	162
Convert UPC-E1 to UPC-A	162
EAN-8/JAN-8 Extend	163
Bookland ISBN Format	164
UCC Coupon Extended Code	165

Table of Contents

Coupon Report	166
ISSN EAN	167
Code 128	168
Enable/Disable Code 128	168
Set Lengths for Code 128	169
Enable/Disable GS1-128 (formerly UCC/EAN-128)	171
Enable/Disable ISBT 128	171
ISBT Concatenation	172
Check ISBT Table	173
ISBT Concatenation Redundancy	173
Code 128 Security Level	174
Code 128 Reduced Quiet Zone	175
Ignore Code 128 <FNC4>	175
Code 128 Exclusive	176
Code 39	177
Enable/Disable Code 39	177
Enable/Disable Trioptic Code 39	177
Convert Code 39 to Code 32	178
Code 32 Prefix	179
Set Lengths for Code 39	180
Code 39 Check Digit Verification	181
Transmit Code 39 Check Digit	181
Code 39 Full ASCII Conversion	182
Code 39 Security Level	183
Code 39 Reduced Quiet Zone	184
Code 39 Buffering - Scan & Store	184
Code 93	187
Enable/Disable Code 93	187
Set Lengths for Code 93	187
Code 11	189
Code 11	189
Set Lengths for Code 11	189
Code 11 Check Digit Verification	191
Transmit Code 11 Check Digits	192
Interleaved 2 of 5 (ITF)	193
Enable/Disable Interleaved 2 of 5	193
Set Lengths for Interleaved 2 of 5	194
I 2 of 5 Check Digit Verification	196
Transmit I 2 of 5 Check Digit	197
Convert I 2 of 5 to EAN-13	197
I 2 of 5 Security Level	198
I 2 of 5 Reduced Quiet Zone	199
Discrete 2 of 5 (DTF)	200
Enable/Disable Discrete 2 of 5	200
Set Lengths for Discrete 2 of 5	201
Codabar (NW - 7)	203
Enable/Disable Codabar	203
Set Lengths for Codabar	203
CLSI Editing	205
NOTIS Editing	205
Codabar Upper or Lower Case Start/Stop Characters Detection	206

Table of Contents

MSI	207
Enable/Disable MSI	207
Set Lengths for MSI	207
MSI Check Digits	209
Transmit MSI Check Digit(s)	209
MSI Check Digit Algorithm	210
Chinese 2 of 5	211
Enable/Disable Chinese 2 of 5	211
Matrix 2 of 5	212
Enable/Disable Matrix 2 of 5	212
Set Lengths for Matrix 2 of 5	212
Matrix 2 of 5 Check Digit	214
Transmit Matrix 2 of 5 Check Digit	214
Korean 3 of 5	215
Enable/Disable Korean 3 of 5	215
Inverse 1D	216
GS1 DataBar	217
GS1 DataBar-14	217
GS1 DataBar Limited	217
GS1 DataBar Expanded	218
Convert GS1 DataBar to UPC/EAN	218
GS1 DataBar Limited Security Level	219
Composite	220
Composite CC-C	220
Composite CC-A/B	220
Composite TLC-39	221
UPC Composite Mode	222
Composite Beep Mode	223
GS1-128 Emulation Mode for UCC/EAN Composite Codes	223
2D Symbolologies	224
Enable/Disable PDF417	224
Enable/Disable MicroPDF417	224
Code 128 Emulation	225
Data Matrix	226
GS1 Data Matrix	226
Data Matrix Inverse	227
Maxicode	227
QR Code	228
GS1 QR	228
MicroQR	229
Inverse QR	229
Aztec	230
Aztec Inverse	230
Han Xin	231
Han Xin Inverse	231
Postal Codes	232
US Postnet	232
US Planet	232
Transmit US Postal Check Digit	233
UK Postal	233
Transmit UK Postal Check Digit	234

Table of Contents

Japan Postal	234
Australia Post	235
Australia Post Format	236
Netherlands KIX Code	237
USPS 4CB/One Code/Intelligent Mail	237
UPU FICS Postal	238
Mailmark	238
Canada Post	239
Symbology-Specific Security Levels	240
Redundancy Level	240
Security Level	242
1D Quiet Zone Level	243
Intercharacter Gap Size	244
Report Version	244
Macro PDF Features	245
Flush Macro Buffer	245
Abort Macro PDF Entry	245
OCR Programming	
Introduction	246
OCR Programming Parameters	248
Enable/Disable OCR-A	248
OCR-A Variant	248
Enable/Disable OCR-B	250
OCR-B Variant	251
Enable/Disable MICR E13B	254
Enable/Disable US Currency Serial Number	255
OCR Orientation	255
OCR Lines	257
OCR Minimum Characters	257
OCR Maximum Characters	258
OCR Subset	258
OCR Quiet Zone	259
OCR Template	260
OCR Check Digit Modulus	269
OCR Check Digit Multiplier	270
OCR Check Digit Validation	271
Inverse OCR	276
123Scan and Software Tools	
Introduction	277
123Scan	277
Communication with 123Scan	278
123Scan Requirements	278
123Scan Information	278
Scanner Control App (SCA)	279
Advanced Data Formatting (ADF)	279
Multicode Data Formatting (MDF)	280
Preferred Symbol	280

Maintenance and Troubleshooting

Introduction	281
Maintenance	281
Battery Safety Guidelines	281
Long Term Storage	282
Cleaning Instructions	282
Approved Cleanser Active Ingredients	282
Harmful Ingredients	282
Cleaning Instructions	282
Special Cleaning Notes	282
Cleaning Materials Required	283
Cleaning Frequency	283
Cleaning the RS6000	283
Cleaning Cradle Connectors	284
Cleaning the Comfort Pads	284
Comfort Pad Replacement	285
Large Comfort Pad Removal	285
Small Comfort Pad Removal	286
Small Comfort Pad Installation	286
Large Comfort Pad Installation	287
Trigger Assembly Replacement	288
Trigger Assembly Removal	288
Trigger Assembly Installation	288
Converting Between Trigger and Triggerless Configuration	290
Convert to Trigger Assembly	290
Convert to Triggerless Assembly	291
Finger Strap Replacement (Trigger Swivel Assembly)	292
Finger Strap Removal (Trigger Swivel Assembly)	292
Finger Strap Installation (Trigger Swivel Assembly)	293
Finger Strap Replacement (Trigger Swivel Assembly with Cam Buckle)	293
Finger Strap Removal (Trigger Swivel Assembly with Cam Buckle)	293
Finger Strap Installation (Trigger Swivel Assembly with Cam Buckle)	296
Finger Strap Replacement (Triggerless Strap Holder)	298
Finger Strap Removal (Triggerless Strap Holder)	298
Finger Strap Installation (Triggerless Strap Holder)	298
Strap Buckle Replacement	299
Strap Buckle Removal	299
Strap Buckle Installation	299
Troubleshooting	300
RS6000	300
Cradles	301

Specifications

RS6000 Technical Specifications	302
Cradle Technical Specifications	306
1-Slot RS6000 USB Charging Cradle Technical Specifications	306
2-Slot WT6000/RS6000 Charging Cradle Technical Specifications	306
5-Slot RS6000 Charge Only Cradle Technical Specifications	307
10-Slot WT6000/RS6000 Charge Only Cradle Technical Specifications	307
10-Slot RS6000 Charge Only Cradle Technical Specifications	308

Table of Contents

4-Slot Battery Charger Technical Specifications	308
20-Slot Battery Charger Technical Specifications	309
Decode Distances	310
Decode Range Information	311
Standard Range Decode Zone	311
Medium Range Decode Zone	312
Standard Default Parameters	
Standard Default Parameters Table	313
Programming Reference	
Symbol Code Identifiers	322
AIM Code Identifiers	323
Alphanumeric and Numeric Bar Codes	
Numeric Bar Codes	328
Cancel	329
Sample Bar Codes	
Code 39	347
UPC/EAN	347
UPC-A, 100%	347
EAN-13, 100%	348
Code 128	348
Interleaved 2 of 5	348
GS1 DataBar-14	348
PDF417	349
Data Matrix	349
Maxicode	349
QR Code	350
US Postnet	350
UK Postal	350
Country Codes	
Introduction	351
Country Keyboard Types (Country Codes)	352
Country Code Pages	
Introduction	367
Country Code Page Defaults	367
Country Code Page Bar Codes	371
CKJ Decode Control	
Introduction	380

Table of Contents

CJK Control Parameters	381
Unicode Output Control	381
CJK Output Method to Windows Host	382
Non-CJK UTF Bar Code Output	384
Unicode/CJK Decode Setup with Windows Host	386
Setting Up the Windows Registry Table for Unicode Universal Output	386
Adding CJK IME on Windows	386
Selecting the Simplified Chinese Input Method on the Host	387
Selecting the Traditional Chinese Input Method on the Host	388

ASCII Character Sets

Index

About This Guide

Introduction

The RS6000 Ring Scanner, also referred to as the Bluetooth Ring Scanner, is a wearable bar code scan solution for both 1D and 2D bar code symbologies. The RS6000 is also compatible with a wide range of mobile computers communicating over Bluetooth.

The RS6000 User Guide provides additional information that is not covered by the Quick Reference Guide and is helpful for application developers and customers alike.

This User Guide provides information on operating the RS6000 for the first time, using the RS6000, resetting and capturing data.

The guide also covers issues such as charging and testing the RS6000 battery, troubleshooting, maintenance, firmware update and configuration of the RS6000. Sample bar codes are provided for configuring and testing the RS6000.

Documentation Set

The documentation set for the RS6000 is divided into guides that provide information for specific user needs.

- **RS6000 Quick Start Guide** - describes how to get the RS6000 ring scanner up and running.
- **RS6000 Regulatory Guide** - provides all regulatory, service and EULA information for the RS6000 ring scanner.
- **RS6000 User Guide** - describes how to set up and use the RS6000 ring scanner and the accessories.
- **Advanced Data Formatting Programmer Guide** - describes how to customize data before transmission to the host device.
- **Enterprise Mobility Developer Kit (EMDK)** - provides API information for writing applications.

Model Configurations

This guide covers the following configurations:

Table 1 RS6000 Configurations

Model	RS6000 Engine Performance	Standard Battery	Trigger	Cam Buckle	Proximity Sensor	Bluetooth	NFC
RS60B0-SRSTWR	Standard Range	X	X		X	X	X
RS60B0-SRSCWR	Standard Range	X	X	X	X	X	X
RS60B0-SRSNWR	Standard Range	X			X	X	X
RS60B0-SRSFWR	Standard Range	X	X			X	X
RS60B0-SRSDWR	Standard Range	X	X	X		X	X
RS60B0-MRSTWR	Medium Range	X	X		X	X	X
RS60B0-MRSCWR	Medium Range	X	X	X	X	X	X
RS60B0-MRSNWR	Medium Range	X			X	X	X

Chapter Descriptions

Topics covered in this guide are as follows:

- [Getting Started](#) provides information on getting the RS6000 up and running for the first time, basic instructions for using the RS6000 and instructions for resetting the RS6000 and capturing data.
- [Bluetooth Communications](#) describes the Bluetooth connection modes of the RS6000 to Zebra and non-Zebra devices.
- [Accessories](#) provides information on available accessories.
- [RS6000 Configuration and Update](#) provides instructions for firmware update and configuration of the RS6000 operation.
- [Configuring Motion and Proximity](#) describes the auto-triggering feature of triggerless RS6000 models and provides programming bar codes for configuring this feature.
- [Miscellaneous Imager Options](#) provides information on programming the RS6000 to perform various functions, or activating different features.
- [Symbologies](#) details symbology features and provides programming bar codes for selecting these features.
- [OCR Programming](#) describes how to set up the RS6000 for OCR programming.
- [123Scan and Software Tools](#) describes the Zebra software tools available for customizing scanner operation.
- [Maintenance and Troubleshooting](#) provides troubleshooting, cleaning, part replacement and technical specifications for the RS6000.
- [Specifications](#) provides RS6000 and charger technical specifications.
- [Standard Default Parameters](#) provides a list of R6000 parameters and default values.

- [Programming Reference](#) provides a table of AIM code identifiers, ASCII character conversions, and keyboard maps.
- [Alphanumeric and Numeric Bar Codes](#) includes the numeric bar codes to scan for parameters requiring specific numeric or alphanumeric values.
- [Sample Bar Codes](#) provides sample bar code types.
- [Country Codes](#) provides bar codes for programming the country keyboard type for the Bluetooth keyboard (HID).
- [Country Code Pages](#) provides bar codes for selecting code pages for the programmed country keyboard type.
- [CKJ Decode Control](#) describes control parameters for CJK (Chinese, Japanese, Korean) bar code decode through Bluetooth HID Keyboard Emulation mode.
- [ASCII Character Sets](#) provides ASCII value character tables.

Notational Conventions

The following conventions are used in this document:

- “tablet” refers to the Zebra ET5x tablet.
- **Bold** text is used to highlight the following:
 - Dialog box, window and screen names
 - Drop-down list and list box names
 - Check box and radio button names
 - Icons on a screen
 - Key names on a keypad
 - Button names on a screen.
- Bullets (•) indicate:
 - Action items
 - Lists of alternatives
 - Lists of required steps that are not necessarily sequential.
- Sequential lists (e.g., those that describe step-by-step procedures) appear as numbered lists.

Related Documents

- Quick Start Guide: RS6000, p/n MN-002748-xx
- Regulatory Guide: RS6000, p/n MN-002703-xx
- Advanced Data Formatting Programmer Guide, p/n 72E-69680-xx
- Enterprise Mobility Developer Kit (EMDK)

For the latest version of this guide and all guides, go to: zebra.com/support.

Service Information

If you have a problem with your equipment, contact Zebra Support for your region. Contact information is available at: zebra.com/support.

When contacting Support, please have the following information available:

- Serial number of the unit
- Model number or product name
- Software type and version number

The following information should be available when reporting a problem:

- Customer name
- Application used
- Configuration (trigger/triggerless)
- RS6000 or Cradle version number
- See [Retrieving the RS6000 Log File on page 103](#) to retrieve and E-mail the RS6000 log to the support representative
- Occurrence (always, once out of 10 attempts, etc...)
- Suggested steps to reproduce the problem

Zebra responds to calls by email, telephone or fax within the time limits set forth in support agreements.

If your problem cannot be solved by Zebra Customer Support, you may need to return your equipment for servicing and will be given specific directions. Zebra is not responsible for any damages incurred during shipment if the approved shipping container is not used. Shipping the units improperly can possibly void the warranty.

If you purchased your Zebra business product from a Zebra business partner, contact that business partner for support.

Provide Documentation Feedback

If you have comments, questions, or suggestions about this guide, send an email to EVM-Techdocs@zebra.com.

Getting Started

Introduction

This chapter describes the features of the RS6000 Ring Scanner and explains how to install and charge the battery, capture data and reset the RS6000.

Unpacking

Carefully remove all protective material from around the equipment and save the shipping container for later storage and shipping.

After opening the shipping box, inspect the contents. You should have received the following:

- RS6000
- Battery
- Regulatory Guide.

Inspect the equipment for damage. If you are missing any equipment or if you find any damaged equipment, contact the Zebra Support immediately. See [Service Information on page 16](#) for contact information.

Configuration Features

Figure 1 RS6000 Triggered Configuration Features

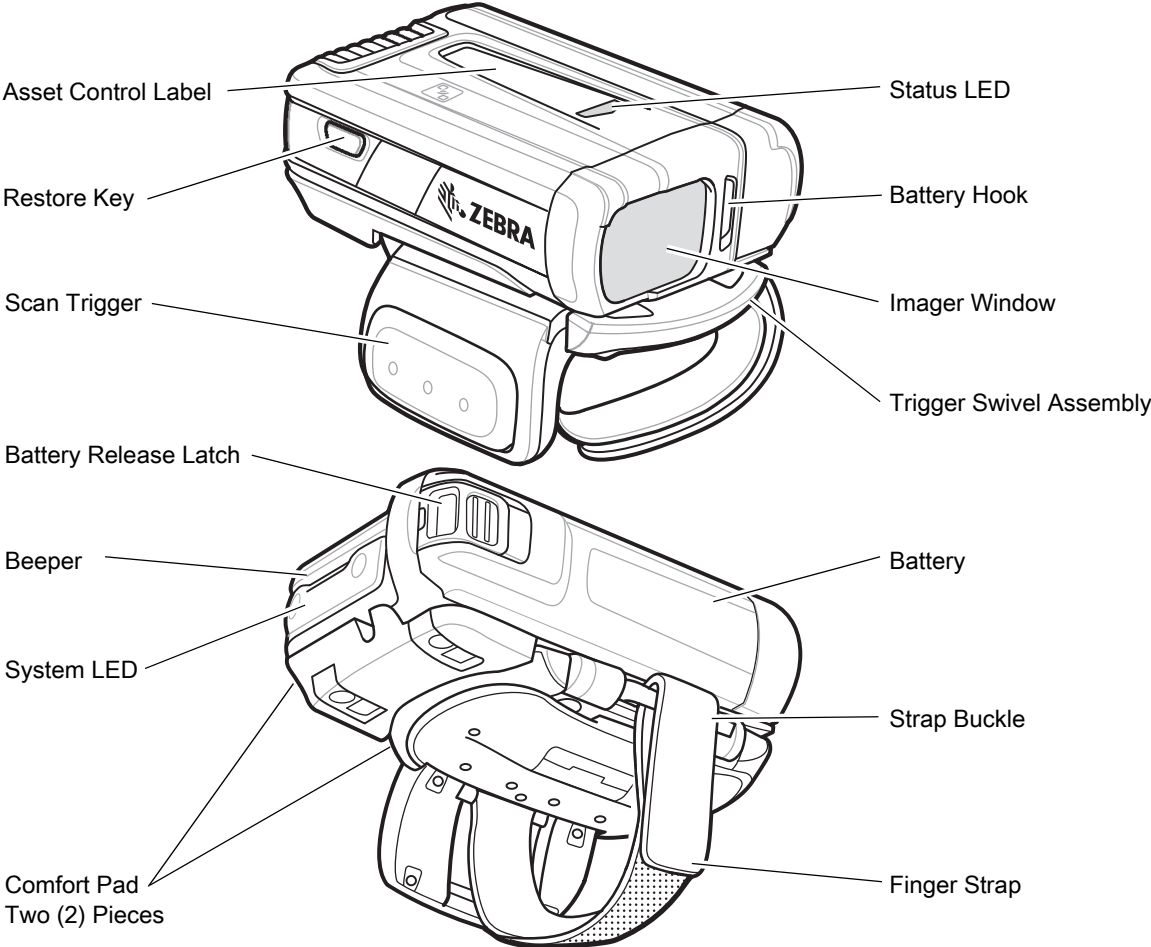
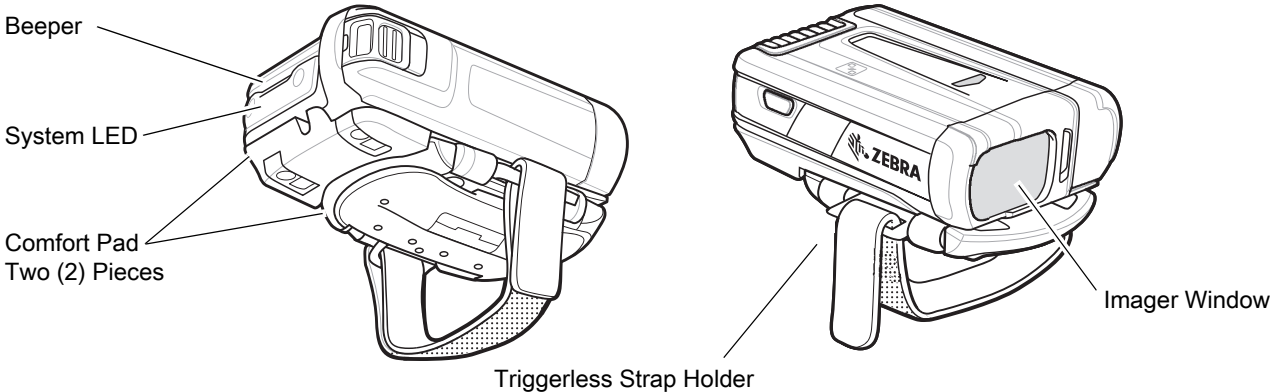

Figure 2 RS6000 Triggerless Configuration Features



Status Indications

The RS6000 has System notification LEDs on the back of the device to display system and decode status and a Status LED on the top of the device to display Bluetooth and battery status. The RS6000 is also equipped with a beeper that issues different beep sequences and patterns to indicate status. The Scan LEDs provide identical indications for ambidextrous usage.

Table 2 defines the System and Status LED and beep sequence indications that occur to indicate status.

Table 2 Status LED Indications

LED Type	LED Indication	Beep Indication	Description
Standard Use			
System	Green	Low/Medium/High	Device is powered on.
Scanning Indications			
System	Green single flash	High	A bar code has been decoded
System	Red	4x Low	Transmission error.
System	Red	5x Low	Conversion or format error.
System	Red	Low/High/Low/High	Out of batch memory storage. Unable to store a new bar code.
Radio Indications			
System and Status	Red/Green blinking	6x Short High	Device in paging state.
Status	Blue double blink	High/low	Bluetooth communication is disconnected.
Status	Blue slow blinking	None	Attempting to reconnect over Bluetooth.
Status	None	Low/high	Bluetooth connection established.
Status	None	Long low/ long high	Bluetooth connection attempt failed.
Status	Blue during beep sequence	Long low/ long high/ Long low/ long high	Bluetooth connection attempt is rejected.
Status	Blue slow blinking	5x High	Attempting to reconnect over Bluetooth (disabled by default).
Status	Blue blinking	3x Short high	Bluetooth disconnect indication (disabled by default).
Battery Indications			
Status	Red	4x Short high	Low battery indicator.
Status	Green/Amber/Red	N/A	Battery charge level indication (hold trigger for three seconds to activate). Green is more than 40% Amber is between 10% and 39% Red is less than 10%

Table 2 Status LED Indications (Continued)

LED Type	LED Indication	Beep Indication	Description
Status	Red blinking	N/A	Over temperature or bad battery.
Parameter Programing			
System	Red	Long low/long high beeps	Input error, incorrect bar code or Cancel scanned, wrong entry, incorrect bar code programming sequence; remain in program mode.
System	Green	High/low beeps	Keyboard parameter selected. Enter value using bar code keypad.
System	Green	High/low/high/low beeps	Successful program exit with change in the parameter setting.
Maintenance Indications			
System and Status	Green slow blinking		Scanner connected to 123Scan2.
System and Status	Red fast blinking		File being transferred to the scanner (new configuration parameters or firmware) via 123Scan2.
System and Status	Red slow blinking		Firmware installation.
System and Status	Green		Programing completed successfully (parameters change or firmware updated) via 123Scan2.

RS6000 Activity Modes

The RS6000 is capable of three modes of activity:

- **Run Mode** – The RS6000 is scanning or transferring data using Bluetooth.
- **Low Power Mode** – The RS6000 enters Standby mode (Low Power Mode) when it is idle for more than one second. The RS6000 wakes-up and returns to busy (run) mode upon at least one of the following events:
 - Scan trigger
 - Motion activity
 - Bluetooth activity
 - NFC field detected
 - Press of the Restore key
 - Insert into charging slot
- **OFF Mode** – The RS6000 is not connected to a power source.

Configuration

Trigger Swivel Assembly - Change Trigger Position

The RS6000 is worn on the index and middle fingers, and triggered with the thumb. The Trigger Swivel Assembly of the RS6000 rotates to provide left-hand or right-hand use.

To change the position of the trigger:

1. Determine whether the RS6000 is used on the right or left hand and rotate the trigger swivel assembly.

Figure 3 Change Trigger Swivel Assembly Position

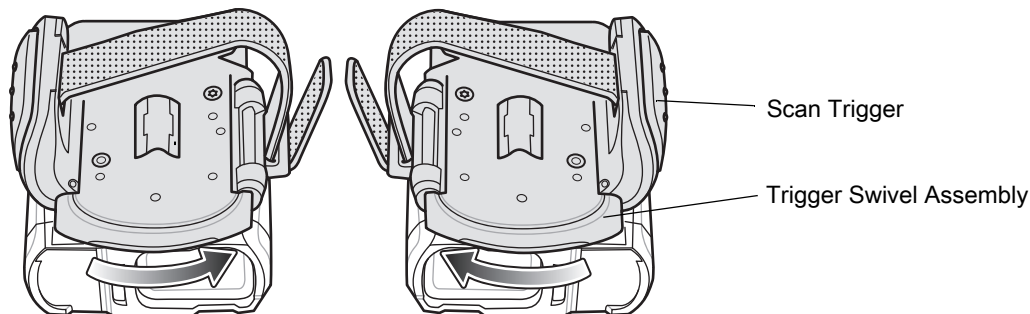

CAUTION: The Trigger Swivel Assembly only rotates 180° around the front of the scan assembly. Do not rotate the Trigger Swivel Assembly past the designed stop.

Rotate the Trigger Swivel Assembly so that the Scan Trigger is positioned next to the thumb when the RS6000 is placed on the index and middle fingers.

Charge the Battery

Before using the RS6000, charge the battery. To charge the RS6000 battery, refer to [Accessories](#).

Install the Battery

1. Align the battery on top of the RS6000 and insert metal corner into the battery compartment.
2. Slide the battery all the way into the locking slot of the RS6000.
3. Firmly press the battery into the RS6000 until a click is heard ensuring the battery release latch is fully engaged with the RS6000.

Figure 4 Install the Battery

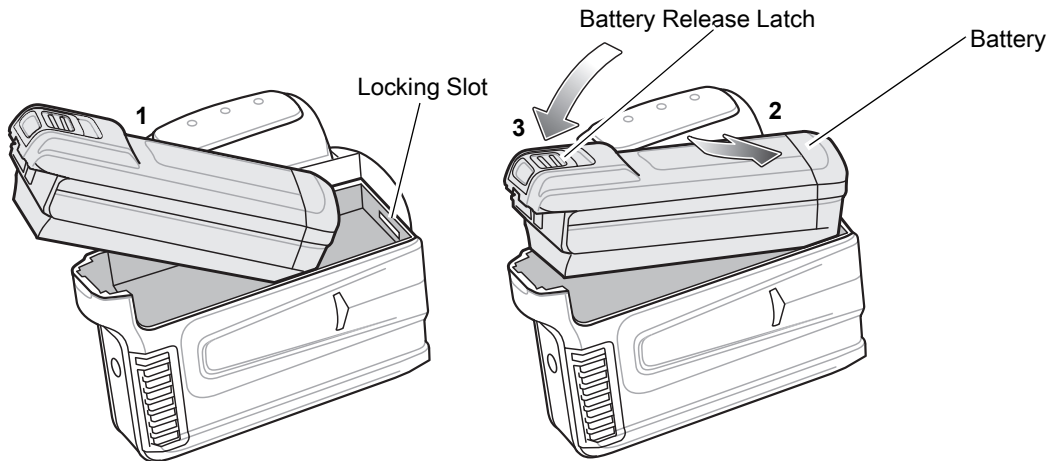

Remove the Battery

1. Hold the RS6000 in one hand.
2. Use finger tip to press the battery release latch.

Figure 5 Remove Battery

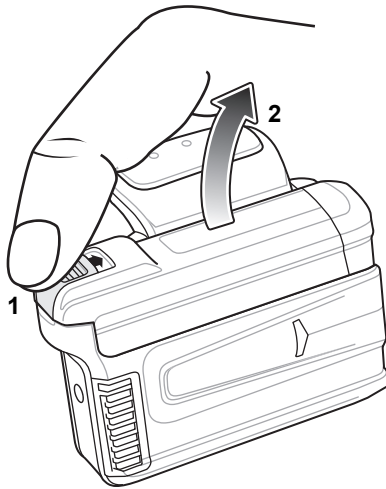

3. While holding down the battery release latch, pull up the battery to release it from the locking slots of the RS6000.

Wearing the RS6000

1. Slide the RS6000 onto the index and middle fingers with the scan trigger next to the thumb.
2. Tighten the finger strap.

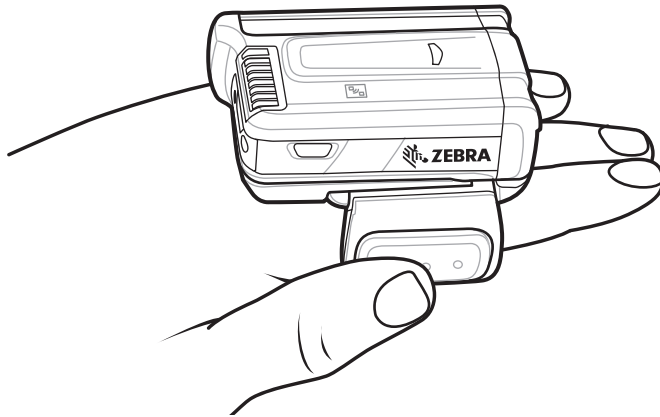
Figure 6 Wearing the RS6000

Bluetooth Connection

The RS6000 sends decoded bar code data to Zebra mobile computers and other devices using Bluetooth. Before using, connect the RS6000 to a device using Bluetooth. See [Bluetooth Communications](#) for configuration.

Scanning

The RS6000 uses digital camera technology to take an image of a bar code and software decoding algorithms are executed to extract the bar code data from the image.

Scan Triggering Modes

Manual Triggering (Triggered models only)

1. Launch a scanning software application on the mobile computer.
2. Position the RS6000 approximately 22.8 cm (9 inches) from a bar code and press the Scan Trigger. Position the cross hair laser beam to cover the bar code. The RS6000 takes a digital picture (image) of the bar code and stores it in memory for decoding.

The Scan LED flashes green and a high beep sounds indicating that the bar code was properly decoded.

✓ **NOTE:** In some configurations proper decoding of a bar code is indicated by the software application running on the mobile computer.

Auto-triggering (Triggerless models only)

The RS6000 is provided with auto-triggering capability. In auto-triggering mode, both motion and proximity sensors are used to trigger the RS6000 when the user intends to scan a bar code.

With auto-triggering activated, the RS6000 automatically scans when motion stops and a bar code is placed within the detection field of the proximity sensor on the RS6000. The RS6000 scans the bar code and then switches to low power mode to conserve power.

To scan a bar code in auto-triggering mode:

1. Launch a scanning software application on the mobile computer.

- Position the RS6000 approximately 22.8 cm (9 inches) from a bar code. Aim the cross hair laser beam to cover the bar code. The RS6000 takes a digital picture (image) of the bar code and stores it in memory for decoding. The Scan LED flashes green and a high beep sounds indicating that the bar code was properly decoded.

✓ **NOTE:** By default the proximity sensor is configured for medium range of up to 40.6 cm (16 inches). The range can be adjusted for short or long range scanning, depending on the scanning application. See page 110.

Aiming the RS6000

The aiming pattern of the RS6000 is a cross hair laser beam with bright center dot (see Figure 7). The virtual rectangle made by the cross hair reflects the field of view of the RS6000. The aiming pattern is used to position the bar code within the field of view.

Figure 7 Cross Hair Laser Beam

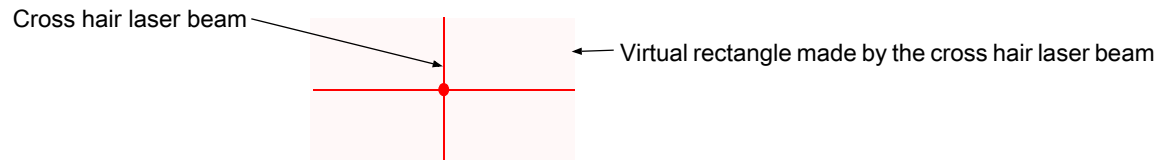

Enter the symbol in any orientation within the virtual rectangle made by the cross hair laser beam, making use of its omnidirectional reading capability within the entire field of view.

Figure 8 Bar Code Scan Orientation

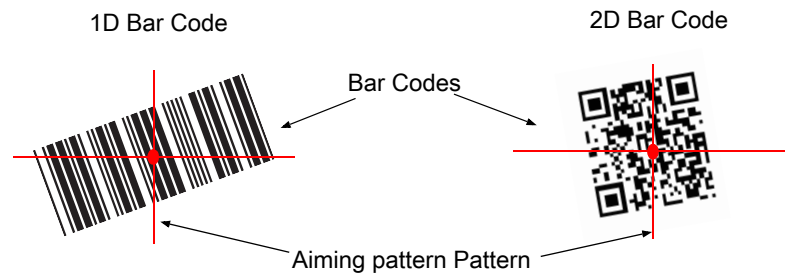

The RS6000 can also read a bar code presented within the aiming pattern but not centered (see the top bar codes on Figure 9). The bar codes marked with X in Figure 9, however, show bar code aiming that may result in no decode.

When using the application on your mobile computer in “Pick List” mode, the Bright Center Dot can be positioned anywhere on the symbol (see Figure 7). The top examples in Figure 9 show acceptable aiming options, while the bottom examples can not be decoded.

Figure 9 Acceptable Aiming Options

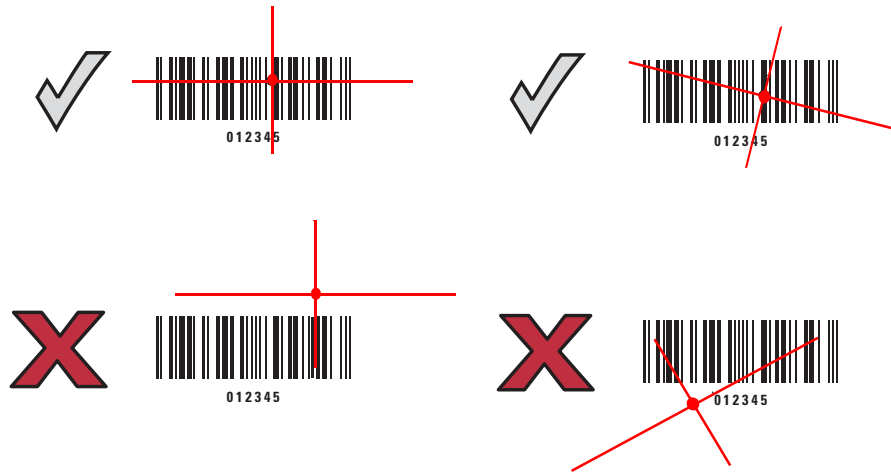

The aiming pattern is smaller when the RS6000 is closer to the symbol and larger when it is farther from the bar code. Scan bar codes with smaller bars or elements (mil size) closer to the RS6000 and those with larger bars or elements (mil size) farther from the RS6000.

1. Position the RS6000 between two and eleven inches from the bar code (depending on the bar code density).

✓ **NOTE:** When a bar code is under transparent plastic or on a mobile computer screen, it is recommended to use a tilt (pitch) or skew scan angle to minimize reflection.

2. Aim the cross hair laser beam to cover the bar code. The RS6000 takes a digital picture (image) of the bar code and stores it in memory for decoding.

The Scan LED flashes green and a high beep sounds indicating that the bar code was properly decoded.

Resetting the RS6000

If the RS6000 stops responding to input, reset it. There are three reset functions, warm boot, cold boot and clean boot. Perform a warm boot first. If the RS6000 still does not respond, perform a cold boot. Perform clean boot to restore the RS6000 to its factory default configuration.

Warm Boot

To perform warm boot, press and hold the Restore Key for more than three seconds and then release. The RS6000 resets when the key is released.

Cold Boot

Cold boot restores the RS6000 operation by performing a power cycle of the device. To perform cold boot, remove and re-insert the battery into the RS6000.

Clean Boot

Clean Boot restores the RS6000 to its factory default configuration.

To perform clean boot:

1. Remove battery.

2. Press and hold the Restore Key.
3. Insert the battery into the RS6000.
4. Continue to press and hold the Restore Key for about five seconds until a chirp is heard and the Scan LEDs flash green. The RS6000 is now in its factory default configuration.

✓ **NOTE:** The factory default configuration is set in the factory or the service center. These parameters are unique for each RS6000 and cannot be changed. The Factory default configuration includes: RS6000 serial number, Bluetooth Device (BD) address, model number, production date and proximity calibration.

Configuration parameters modified on the RS6000 reset to factory defaults after a clean boot.

Bluetooth Communications

Introduction

This chapter provides information about the modes of operation and features available for wireless communication between the RS6000 and hosts. The chapter also includes the parameters necessary to configure the RS6000.

The RS6000 ships with the settings shown in the [Bluetooth Communication Defaults on page 28](#) (also see [Standard Default Parameters](#) for all host device and miscellaneous RS6000 defaults). If the default values suit user requirements, programming is not necessary.

To set feature values, scan a single bar code or a short bar code sequence. The settings are stored in non-volatile memory and are preserved even when the RS6000 is powered down.

To return all features to default values, scan a default bar code in [Default Parameters on page 116](#). Throughout the programming bar code menus, default values are indicated with asterisks (*).



* Indicates Default — *Enable Fuzzy 1D Processing — Feature/Option

Scanning Sequence Examples

In most cases, scan one bar code to set a specific parameter value.

Errors While Scanning

Unless otherwise specified, to correct an error during a scanning sequence, just re-scan the correct parameter.

Bluetooth Communications Parameter Defaults

Table 3 lists the defaults for Bluetooth radio communication parameters. If you wish to change any option, scan the appropriate bar code(s).



NOTE: See [Standard Default Parameters](#) for all user preferences, hosts, symbologies, and miscellaneous default parameters.

In this guide, the parameter numbers listed are the same as the attribute numbers for these parameters.

See [Country Codes](#) for Country Keyboard Types (Country Codes).

Table 3 Bluetooth Communication Defaults

Parameter	Parameter Number	Default	Page Number
Bluetooth Communications Host Types		SSI Bluetooth Classic	
Discoverable Mode	610	General	57
Wi-Fi Friendly Mode		Disable	61
Wi-Fi Friendly Channel Exclusion		Use All Channels	62
Radio Output Power	1324	Class 2	64
Link Supervision Timeout	1698	.5 Seconds	65
HID Wait for Connection	1714	Disable	34
HID Features for Apple iOS	1114	Disable	35
HID Keyboard Keystroke Delay		No Delay (0 msec)	35
CAPS Lock Override		Disable	36
Ignore Unknown Characters		Enable	36
Emulate Keypad		Disable	37
Fast HID Keyboard	1361	Enable	37
Quick Keypad Emulation	1362	Enable	38
Keyboard FN1 Substitution		Disable	38
Function Key Mapping		Disable	39
Simulated Caps Lock		Disable	39
Convert Case		No Case Conversion	40
Beep on Reconnect Attempt	559	Disable	67
Reconnect Attempt Interval	558	30 sec	68
Auto-reconnect	604	Auto-reconnect Immediately	70
Bluetooth Disconnect Indication	822	Disable	71

Table 3 Bluetooth Communication Defaults (Continued)

Parameter	Parameter Number	Default	Page Number
Bluetooth Disconnect Indication After Battery Insert	823	120 sec	72
Bluetooth Disconnect Indication After Bluetooth Disconnection	824	30 sec	73
Bluetooth Disconnect Indication - Cycle Time		10 sec	74
Bluetooth Disconnect Indication - Beep Type		3 High/Short Beeps	75
Beep on Insertion	288	Enable	118
Beep on <BEL>	150	Enable	51
Toggle Pairing	1322	Disable	76
Force Pairing Save	795	Enable	76
Auto Unpairing	1708	Disable	77
Batch Mode	544	Normal (Do Not Batch Data)	79
PIN Code (Set and Store)	552	12345	58
Variable Pin Code	608	Static (Default PIN code is 12345)	59
Bluetooth Security Levels	1393	Low	60

Bluetooth Status Indications

When the RS6000 is pairing or re-establishing a connection to a computer, it issues various beep sequences indicating successful or unsuccessful operations. See [Table 2 on page 19](#) for all beep sequences and LED displays including those which occur during pairing operations.

Bluetooth Connection Modes

The RS6000 can connect to a host computer using the following Bluetooth modes:

- Human Interface Device (HID)
- Simple Serial Interface (SSI)
- Serial Port Profile (SPP).

Keyboard Emulation

The Bluetooth Human Interface Device (HID) profile enables the RS6000 to emulate a Bluetooth keyboard input device and connect to a host computer. The RS6000 supports two versions of the Bluetooth HID profile.

HID Bluetooth Classic

Enables the RS6000 to communicate using Bluetooth HID profile to a host computer through Bluetooth Classic radio. The RS6000 is capable of operating in Slave (discoverable) or Master mode.

HID Bluetooth Low Energy (Discoverable)

Enables the RS6000 to communicate using Bluetooth HID profile to a host computer through Bluetooth Low Energy radio. The RS6000 operates in Slave (discoverable) mode when BT HID Low Energy is enabled.

Low Energy (LE) Bluetooth has a smaller RF footprint (bandwidth) than Classic Bluetooth. The smaller RF footprint of LE Bluetooth significantly improves Wi-Fi co-existence. Due to its smaller RF bandwidth, LE Bluetooth is up to seven times slower than Classic Bluetooth (0.27 Mbps versus 0.7-2.1 Mbps). Data intensive activities such as firmware updates, can take significantly longer.

✓ **NOTE:** Not all host devices support Bluetooth Low Energy. Verify that your device supports Bluetooth Low Energy mode before attempting to connect to the RS6000.

Table 4 HID Bluetooth Bar Codes

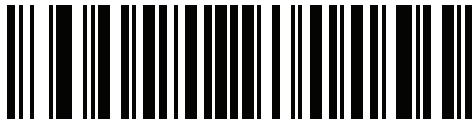

HID Bluetooth Classic

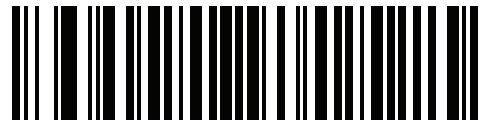

HID Bluetooth Low Energy

HID Setup

HID Bluetooth Connection to iOS/iPad/iPhone

1. Perform clean boot. See [Clean Boot on page 25](#)
2. Scan the appropriate HID Bluetooth Bar Code from page 30.
3. Perform a Cold Boot by removing and re-installing the battery onto the RS6000. The RS6000 starts to operate and is discoverable as a keyboard.
4. Select **Settings > General > Bluetooth**.
5. Turn Bluetooth **ON**.
6. Select **Bluetooth Settings** and choose RS6000 from the list of discovered devices. The RS6000 displays as RS6000 - xxxxxx, where xxxxxx is the serial number.

HID Bluetooth Connection to Android

1. Perform clean boot. See [Clean Boot on page 25](#)

2. Scan the appropriate HID Bluetooth Bar Code from page 30.
3. Perform a Cold Boot by removing and re-installing the battery onto the RS6000. The RS6000 starts to operate and is discoverable as a keyboard.
4. Select **Settings > Wireless & Networks > Bluetooth**
5. Turn Bluetooth **ON**.
6. Select **Bluetooth Settings** and choose RS6000 from the list of discovered devices. The RS6000 displays as RS6000 - xxxxxx, where xxxxxx is the serial number.



IMPORTANT: Some devices may require scanning a PIN to connect. If so, a PIN displays on the device. To enter the required PIN, scan the bar code, [Variable PIN Code on page 59](#) then re-attempt connection. When a beep sounds, indicating the RS6000 is waiting for PIN entry, scan the PIN using the [Alphanumeric and Numeric Bar Codes on page 328](#). Incorrect scanned entries can be deleted by scanning [Cancel on page 329](#).

For more information, see [Variable PIN Code on page 59](#).

HID Bluetooth Connection to Windows 7 or 8



NOTE: For best user experience, it is recommend using Secure Simple Pairing (SSP). Windows 7 SP1 supports Bluetooth 2.1 and as such, supports SSP.

SSP reduces the number of steps to minimal or none when compared to legacy Bluetooth pairing.

If the host computer does not include an integrated Bluetooth module, use a USB Bluetooth dongle.
Use off-the-shelf dongle that supports Bluetooth v2.1 for effortless pairing in SSP.

To pair and connect the RS6000:

1. Perform clean boot. See [Clean Boot on page 25](#)
2. Scan the HID Bluetooth Classic bar code from page 30.
3. Perform a Cold Boot by removing and re-installing the battery onto the RS6000. The RS6000 starts to operate and is discoverable as a keyboard.
4. Right click on Bluetooth icon and select **Add a Device** (Windows 7) or **Add a Bluetooth Device** (Windows 8).

Figure 10 HID - Adding a Device - Windows

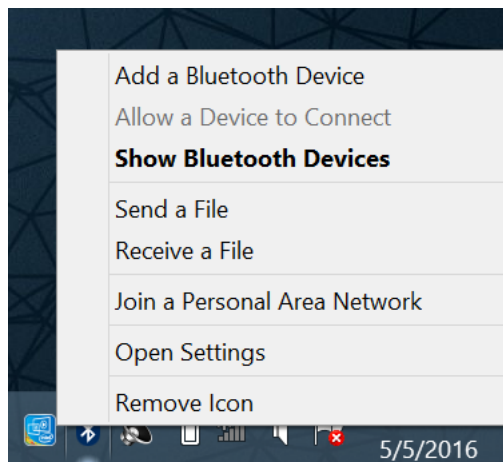

5. From the **Add a device** screen, select the RS6000 (shown as Bluetooth Keyboard) and click **Next**.

Figure 11 HID - Add Device Screen - Windows

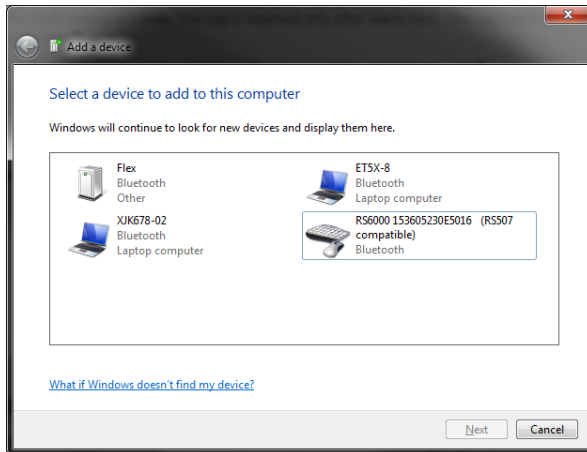

Windows 7

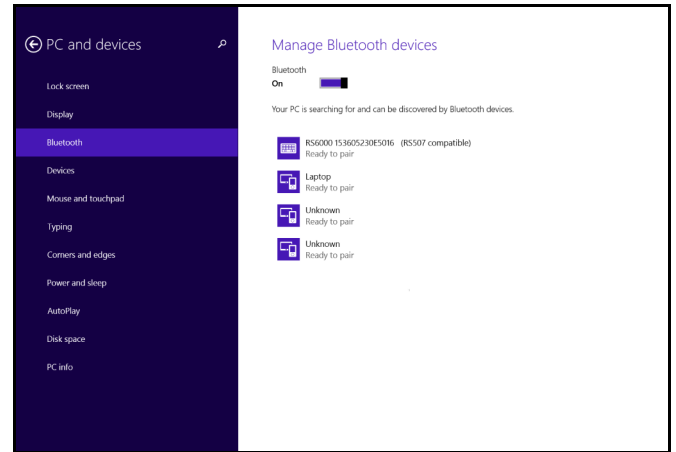

Windows 8

The computer connects to the RS6000 and the following screen displays.

Figure 12 HID - Device Successfully Added Screen - Windows

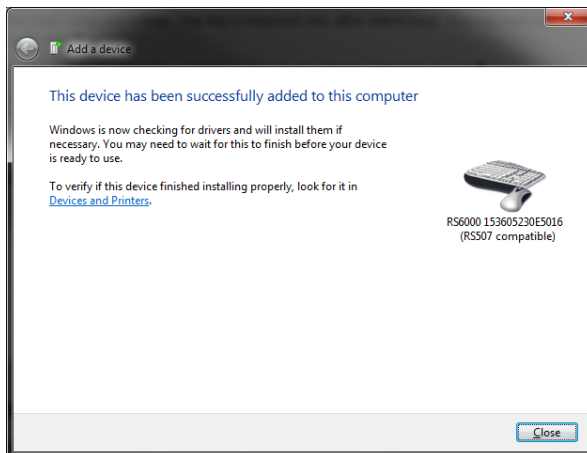

Windows 7

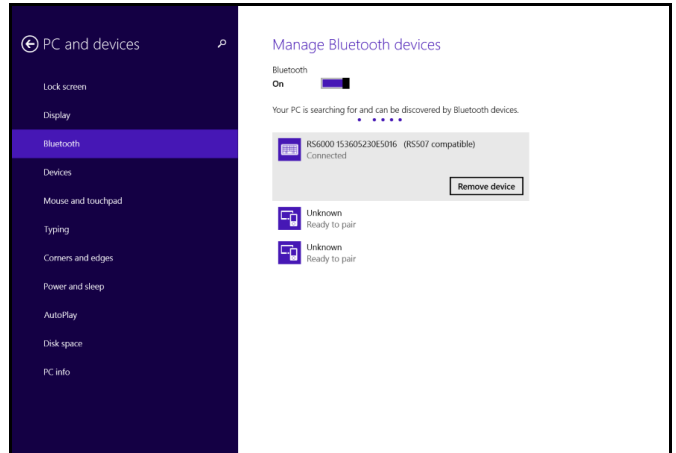

Windows 8

Demonstrating HID Connection

Following a successful connection, data can be scanned into any Windows, iOS or Android application field that accepts keyboard data; for example, in Windows, the Notepad application.

To scan a bar code:

1. Open the Notepad application.
2. Click in the text area.
3. Scan a bar code. The scanned bar code information displays on the Notepad window.

Figure 13 HID - Scanned Bar Code Information On Notepad Window

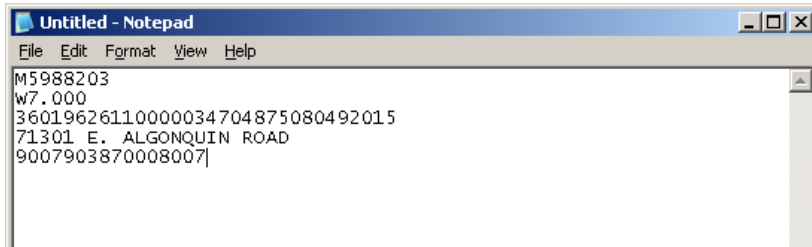

HID Options

The RS6000 supports virtual keyboard emulation for the Apple iOS, and keyboard emulation over the Bluetooth HID profile. In this mode the RS6000 can interact with Bluetooth enabled hosts supporting the HID profile as a Bluetooth keyboard. Scanned data is transmitted to the host as keystrokes.

HID - Wait for Connection

Parameter # 1714



NOTE: This setting applies to first time connection only, when scanner connects to remote device by scanning a pairing bar code.

When disabled, the scanner issues a connection after scanning a pairing bar code. This is the recommended setting for Android devices.

When enabled, the scanner waits for a connection request from a remote device, after scanning a pairing bar code and initiating pairing. This is the recommended setting for Windows devices and VC80.

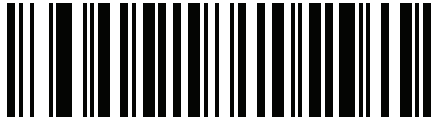

* Disable
(0)

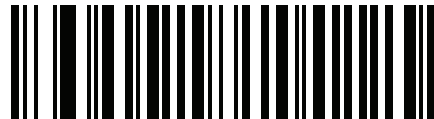

Enable
(1)

HID Features for Apple iOS

Parameter # 1114

This option works with Apple iOS devices to enable the opening and closing of the iOS virtual keyboard by double-pressing the trigger.

✓ **NOTE:** When this feature is enabled, the RS6000 may be incompatible with non-Apple iOS devices.

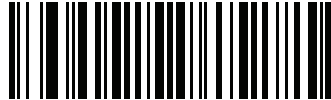

***Disable
(0)**

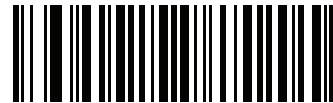

**Enable
(1)**

HID Keyboard Keystroke Delay

This parameter sets the delay, in milliseconds, between emulated keystrokes. Scan a bar code below to increase the delay when the HID host requires a slower transmission of data.



***No Delay (0 msec)**



Medium Delay (20 msec)



Long Delay (40 msec)

HID CAPS Lock Override

When enabled, the case of the data is preserved regardless of the state of the caps lock key. This setting is always enabled for the “Japanese, Windows (ASCII)” keyboard type and can not be disabled.



***Do Not Override Caps Lock Key
(Disable)**



**Override Caps Lock Key
(Enable)**

HID Ignore Unknown Characters

This option applies only to the HID Keyboard Emulation device and IBM device. Unknown characters are characters the host does not recognize. When **Send Bar Codes With Unknown Characters** is selected, all bar code data is sent except for unknown characters, and no error beeps sound. When **Do Not Send Bar Codes With Unknown Characters** is selected, bar code data is sent up to the first unknown character, then the RS6000 issues an error beep.



***Send Bar Codes With Unknown Characters
(Enable)**



**Do Not Send Bar Codes With Unknown Characters
(Disable)**

Emulate Keypad

When enabled, all characters are sent as ASCII sequences over the numeric keypad. For example, ASCII A is sent as "ALT make" 0 6 5 "ALT Break."



***Disable Keypad Emulation**



Enable Keypad Emulation

Fast HID Keyboard

Parameter # 1361

This option transmits Bluetooth HID keyboard data at a faster rate.

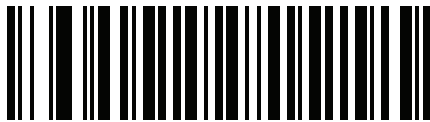

Fast HID Disable



***Fast HID Enable**

Quick Keypad Emulation

Parameter # 1362

- ✓ **NOTE:** This option applies only to a HID Keyboard Emulation Device which has **Emulate Keypad** enabled (see [Emulate Keypad on page 37](#)).

This parameter enables a quicker method of keypad emulation where ASCII sequences are only sent for ASCII characters not found on the keyboard.

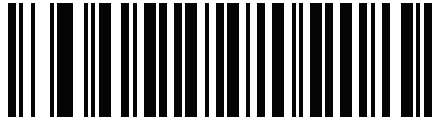

Quick Keypad Emulation Disable

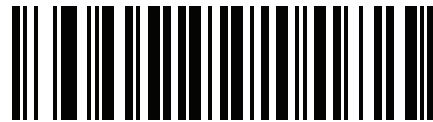

***Quick Keypad Emulation Enable**

HID Keyboard FN1 Substitution

When enabled, this parameter allows replacement of any FN1 character in an EAN128 bar code with a Key Category and value chosen by the user. See [FN1 Substitution Values on page 139](#) to set the Key Category and Key Value.



***Disable Keyboard FN1 Substitution**



Enable Keyboard FN1 Substitution

HID Function Key Mapping

ASCII values under 32 are normally sent as control-key sequences. When this parameter is enabled, the keys in bold are sent in place of the standard key mapping (see [ASCII Character Sets](#)).

Table entries that do not have a bold entry remain the same whether or not this parameter is enabled.



***Disable Function Key Mapping**



Enable Function Key Mapping

Simulated Caps Lock

When enabled, the RS6000 inverts upper and lower case characters on the RS6000 bar code as if the Caps Lock state is enabled on the keyboard. This inversion is done regardless of the current state of the keyboard Caps Lock state.



***Disable Simulated Caps Lock**



Enable Simulated Caps Lock

Convert Case

When enabled, the RS6000 converts all bar code data to the selected case.



***No Case Conversion**



Convert All to Upper Case



Convert All to LowerCase

Country Keyboard Type Change

While in HID mode, the RS6000 supports several keyboard layouts.

To change the North American Standard Keyboards layout to a different country code layout, scan the required bar code corresponding to the country keyboard type. See [Country Codes](#) for country keyboard types.

Simple Serial Interface

Enables communication with Zebra mobile computers. It enables the RS6000 to establish a connection with the host computer over Classic Bluetooth radio.

Simple Serial Interface (SSI) is the RS6000 default connection mode. To set the RS6000 back to SSI mode:

1. Perform clean boot.
2. Scan the SSI Bluetooth Classic bar code.
3. Perform a cold boot by removing and re-installing the battery onto the RS6000.

✓ **NOTE:** The RS6000 is not discoverable in this mode.

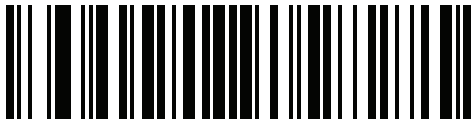

SSI Bluetooth Classic

SSI Setup

SSI Bluetooth Connection using NFC

The RS6000 is NFC enabled and supports Bluetooth Tap-to-Pair.

To connect with a WT6000:

1. Check that NFC is enabled on the WT6000.
2. Align the NFC icon of the RS6000 with the NFC icon on the WT6000.

The Status LED blinks blue, indicating that the RS6000 is attempting to establish connection with the WT6000. When connection is established, the Status LED turns off and the RS6000 emits a single string of low/high beeps.

Figure 14 Touch NFC Antennas

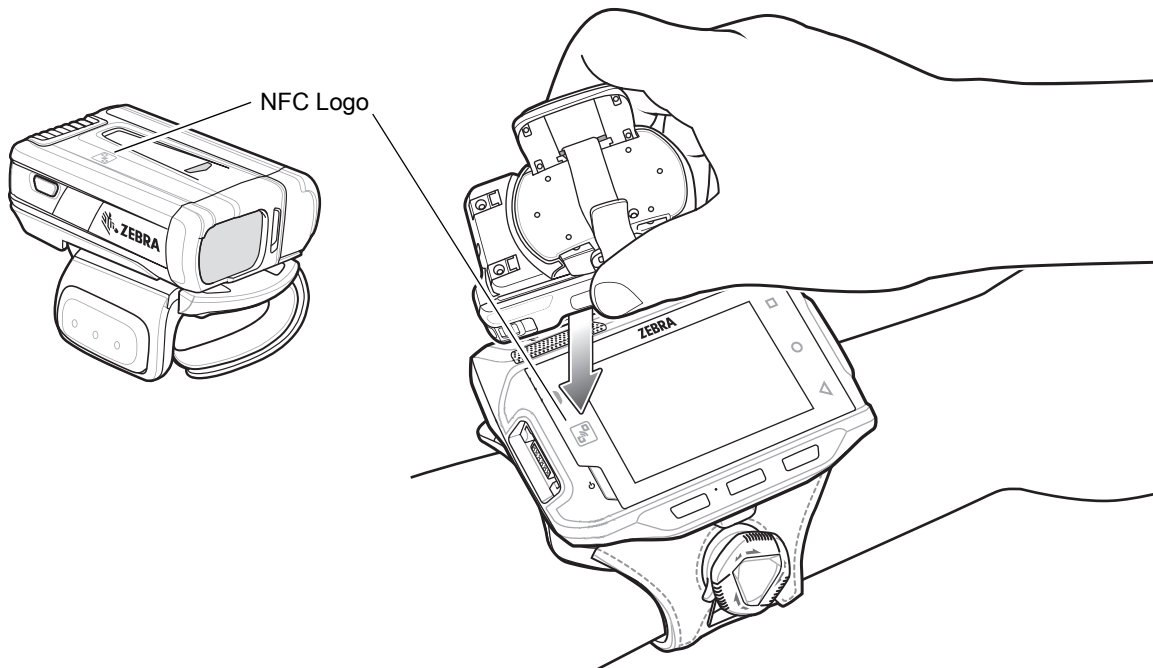

✓ **NOTE:** Not all Zebra device support NFC readers and the Tap-to-Pair feature.

SSI Bluetooth Connection using Scan2Pair

To pair the RS6000 with the WT6000 using SSI:

1. On the WT6000, touch  > . The Bluetooth Pairing Utility opens.

Figure 15 Bluetooth Pairing Utility



2. Using the RS6000, scan the bar code on the screen.
The Status LED blinks blue indicating that the RS6000 is attempting to establish connection with the WT6000. When connection is established, the Status LED turns off and the RS6000 emits a single string of low/high beeps.
3. On the WT6000, touch the triangle button to return to the main screen.

SSI Bluetooth Connection using STB3678 cradle

For information on STB3678 cradle configuration and usage refer to the DS36x8 user guide.

To pair the RS6000 with a STB3678 cradle:

1. Connect the STB3678 cradle to the host computer.
2. Using the RS6000, scan the pairing bar code on the STB3678 cradle.

The Status LED blinks blue indicating that the RS6000 is attempting to establish a connection with the STB3678. When the connection is established, the Status LED turns off and the RS6000 emits a single string of low/high beeps.

✓ **NOTE:** Before pairing the RS6000 with a different device, perform clean boot. See [Clean Boot on page 25](#).

Serial Port Profile

The RS6000 can connect to a host computer or other device that supports Bluetooth Serial Port Profile (SPP). Use Bluetooth SPP when connecting to a host computer, tablet, or phone in one of the following modes:

- **Master** - The RS6000 initiates the connection. When configured as SPP Master, that RS6000 is non-discoverable and typically connects to a host using a pairing bar code. Scan the **SPP Bluetooth Classic (Non-Discoverable)** bar code to set the RS6000 to this mode.
- **Slave** - The host computer or device discovers the RS6000 and initiates the connection. When the RS6000 is configured as SPP Slave, it is in discoverable mode. Scan the **Bluetooth Classic (Discoverable)** bar code to set the RS6000 to this mode.

Table 5 SPP Bluetooth Classic Bar Codes

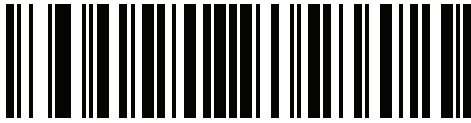

SPP Bluetooth Classic (Non-Discoverable)

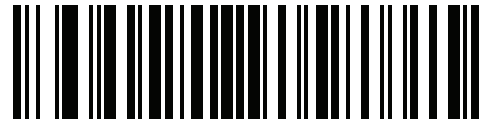

SPP Bluetooth Classic (Discoverable)

- ✓ **NOTE:** Since the SPP connection does not support automatic acknowledgment when the data is received by the computer application, a BELL indication is used. The BELL indication allows the computer application to send single binary character 0x07 to the RS6000 (as defined in ASCII table). Upon receiving the BELL character, the RS6000 beeps. To configure the beep, see [Bell Indication Control on page 52](#).

SPP Setup

SPP Bluetooth Connection to Windows 7 or 8 as Master

1. Perform clean boot. See [Clean Boot on page 25](#).
2. Scan the SPP Bluetooth Classic (Non-Discoverable) bar code from [Table 5](#).
3. Perform a Cold Boot by removing and re-installing the battery onto the RS6000. The RS6000 starts to operate and is discoverable as a Bluetooth serial device.
4. Right click on the Bluetooth icon and select **Open Setting** to add a COM port

Figure 16 SPP - Open Setting Screen - Windows

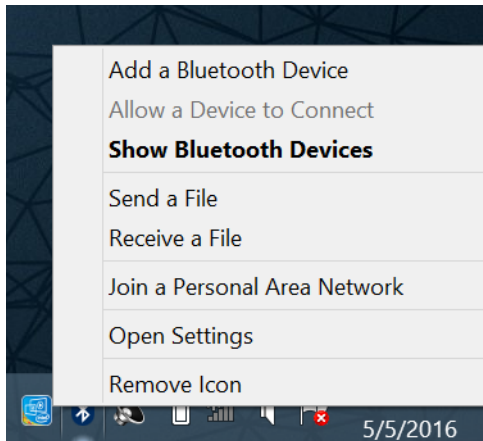

5. Select the **COM Ports** tab and click **Add**.

Figure 17 SPP - Bluetooth Settings - Com Ports Tab

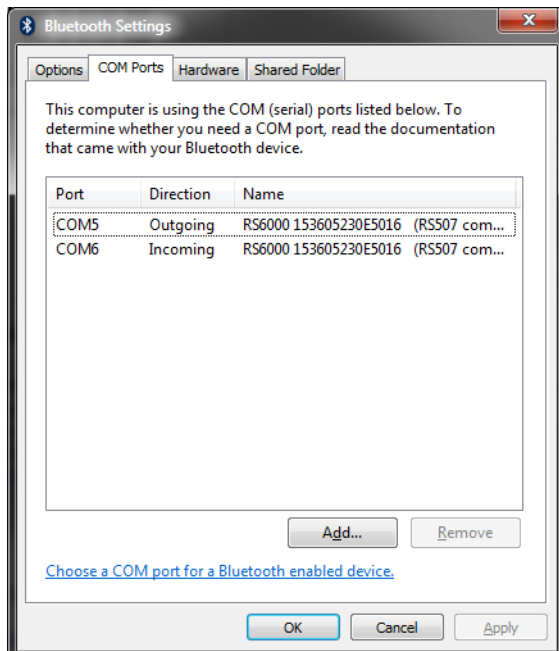

6. Select the **Incoming** radio button and click **OK**.

Figure 18 SPP - Bluetooth Settings - Add Com Port Screen

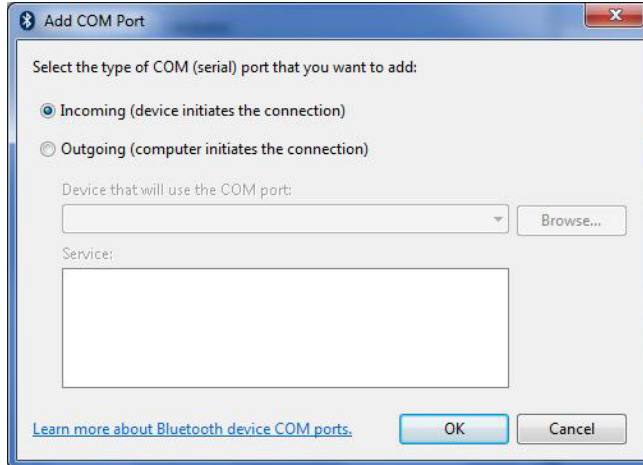

7. Click the **Hardware** tab.
8. Click the **Properties** button.
9. Click the **Advanced** tab to retrieve the Bluetooth radio BD address in the **Address** field.
10. Click **OK**.

Figure 19 SPP - Bluetooth Settings - Bluetooth Radio BD Address

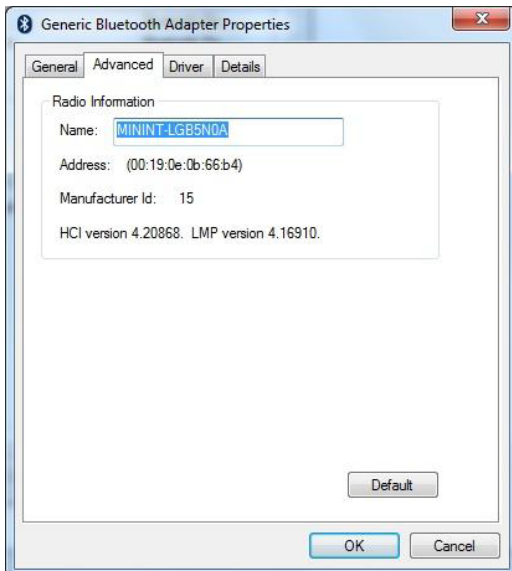

11. Run the PC Tool application.

Figure 20 SPP - PC Tool application

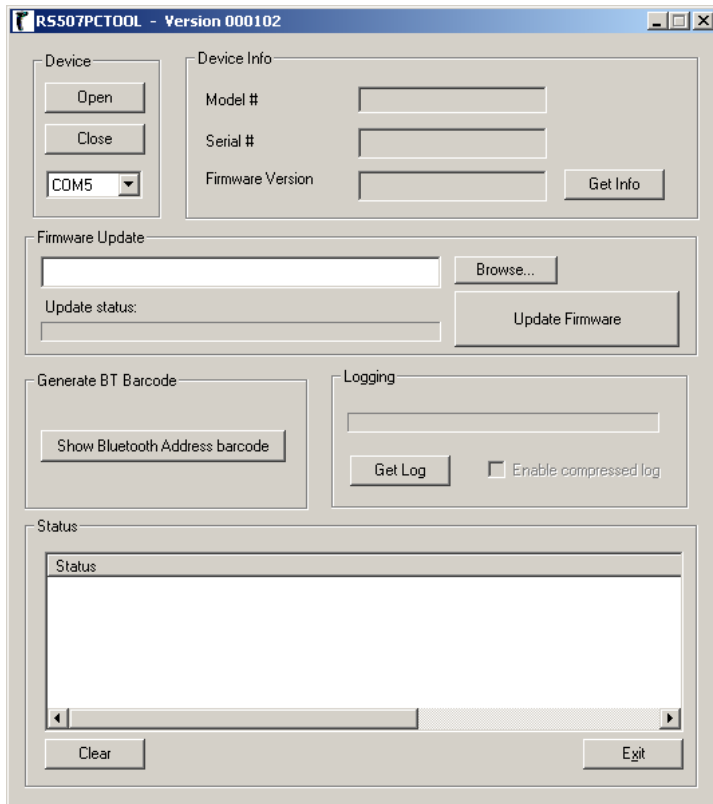

12. Click the **Show Bluetooth Address barcode** button.

13. Manually enter the BD address to the PC Tool application and click the **Generate** button.

Figure 21 SPP - PC Tool Application - Bar Code Generator

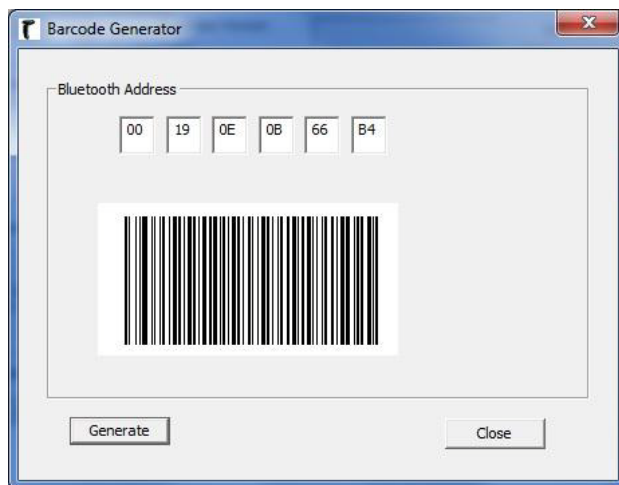

14. Click **Close**.

- Open the incoming COM port assigned (for example, COM7) in the application. After the COM port is opened the computer connects to the RS6000 and a beep will sound. For demonstration, refer to [General Bluetooth Options on page 57](#).

✓ **NOTE:** If the COM port is not opened prior to the connection, the RS6000 will fail to connect.

- To start the connection process aim the RS6000 at about 7" (18 cm) away from the computer screen and scan the bar code of the BD address of the computer (or the other target device).

The RS6000 Scan LEDs start flashing green indicating that the RS6000 is attempting to establish connection with the computer. The following notifications display upon successful connection.

Figure 22 SPP - Device Successfully Added Screen

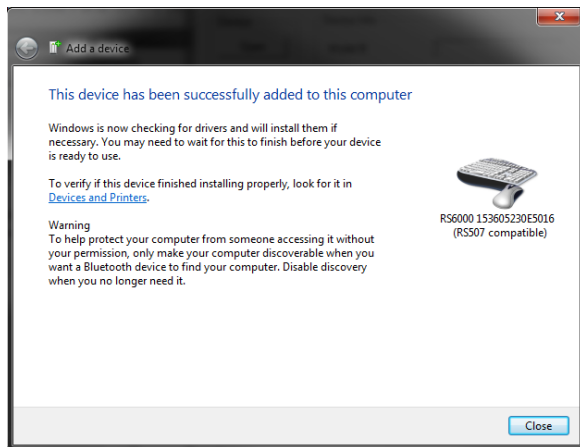

Windows 7

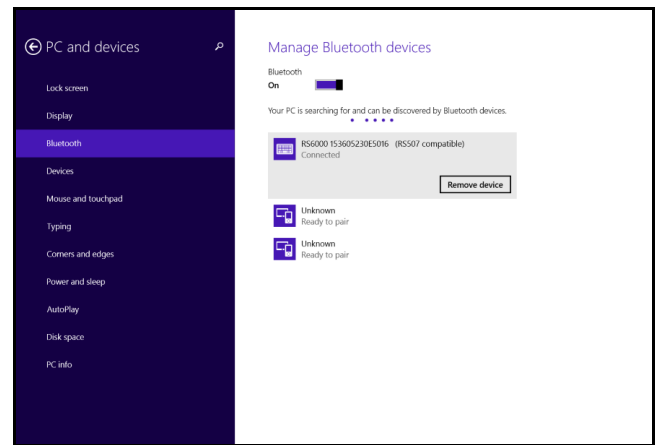

Windows 8

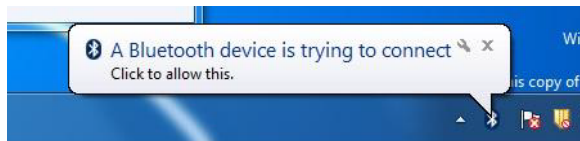

✓ **NOTE:** In case you do not hear the connected beep on the RS6000, press the RS6000 **Restore key** to connect.

SPP Bluetooth Connection to Windows 7 or 8 as Slave

- Perform clean boot. See [Clean Boot on page 25](#).
- Scan the SPP Bluetooth Classic (discoverable) bar code from [Table 5](#).
- Perform a Cold Boot by removing and re-installing the battery onto the RS6000. The RS6000 starts to operate and is discoverable as a Bluetooth serial device.
- Right click the Bluetooth icon and select **Add a Device** (Windows 7) or **Add a Bluetooth Device** (Windows 8).

Figure 23 SPP connection with RS6000 as a Slave - Open Settings

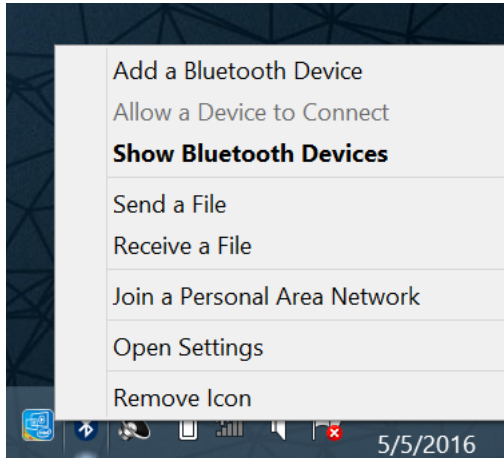

5. Select the RS6000 (see Bluetooth Camera icon below) and click **Next**

Figure 24 SPP connection with RS6000 as a Slave - Add Device Screen

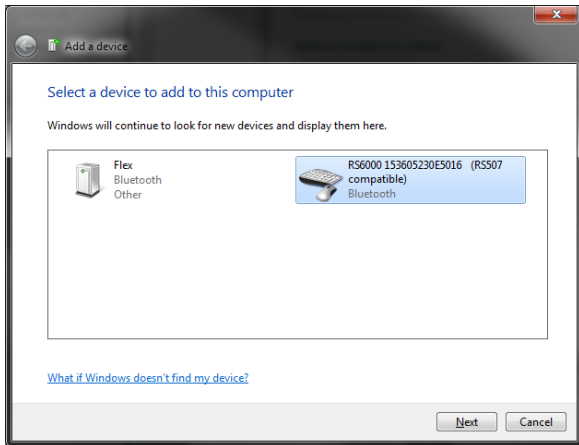

Windows 7

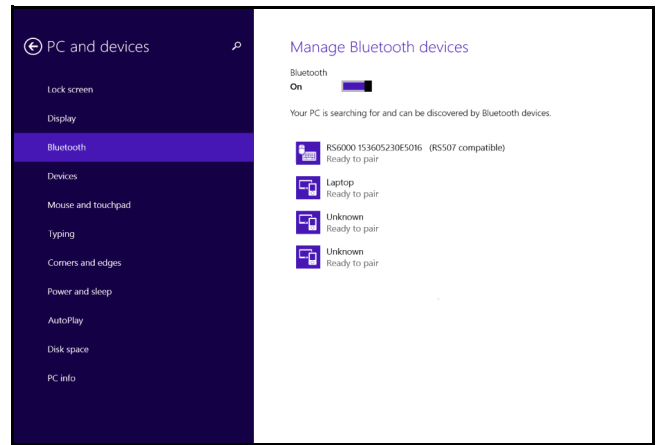

Windows 8

6. The computer attempts to connect to the RS6000

Figure 25 SPP connection with RS6000 as a Slave - Device Successfully Added Screen

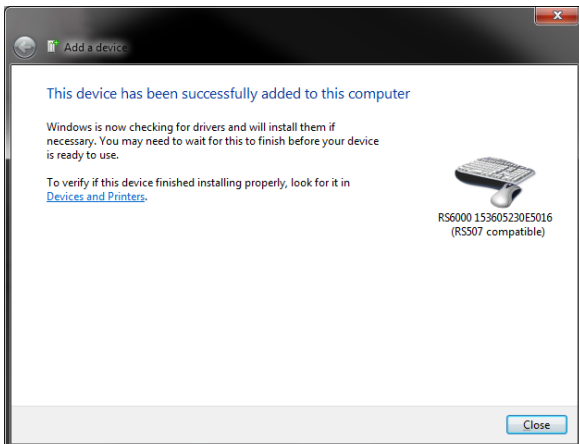

Windows 7

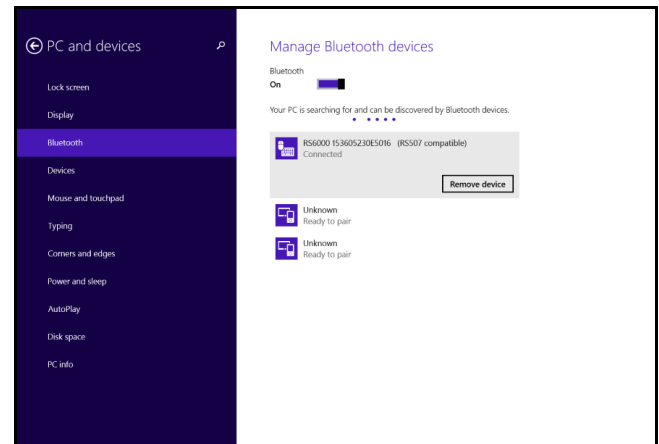

Windows 8

7. Open the incoming COM port assigned (for example, COM7) in the application. After the COM port is opened the computer connects to the RS6000 and a beep will sound. For demonstration, refer to [General Bluetooth Options on page 57](#).

✓ **NOTE:** Make sure the same COM port is closed in other applications.

How to Demonstrate SPP Connection with a Computer

Once SPP connection is established, an application is required to demonstrate the RS6000.

To scan a bar code:

1. If the RS6000 is still connected to the PC Tool application, close the COM port on the PC Tool application.
2. Run a hyper terminal application such as the Tera Term application. (ayera.com/teraterm/download.cfm).

Figure 26 Tera Term Application Screen

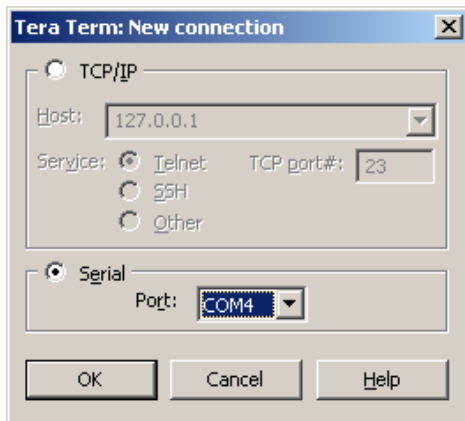

3. Select the virtual COM port set for the RS6000 connection.
4. Scan bar codes. Successful decoding of a bar code is indicated by one green flash of the **Scan LEDs** and a high beep sound. In case of Bluetooth disconnection, the RS6000 emits one high beep followed by four low beeps.

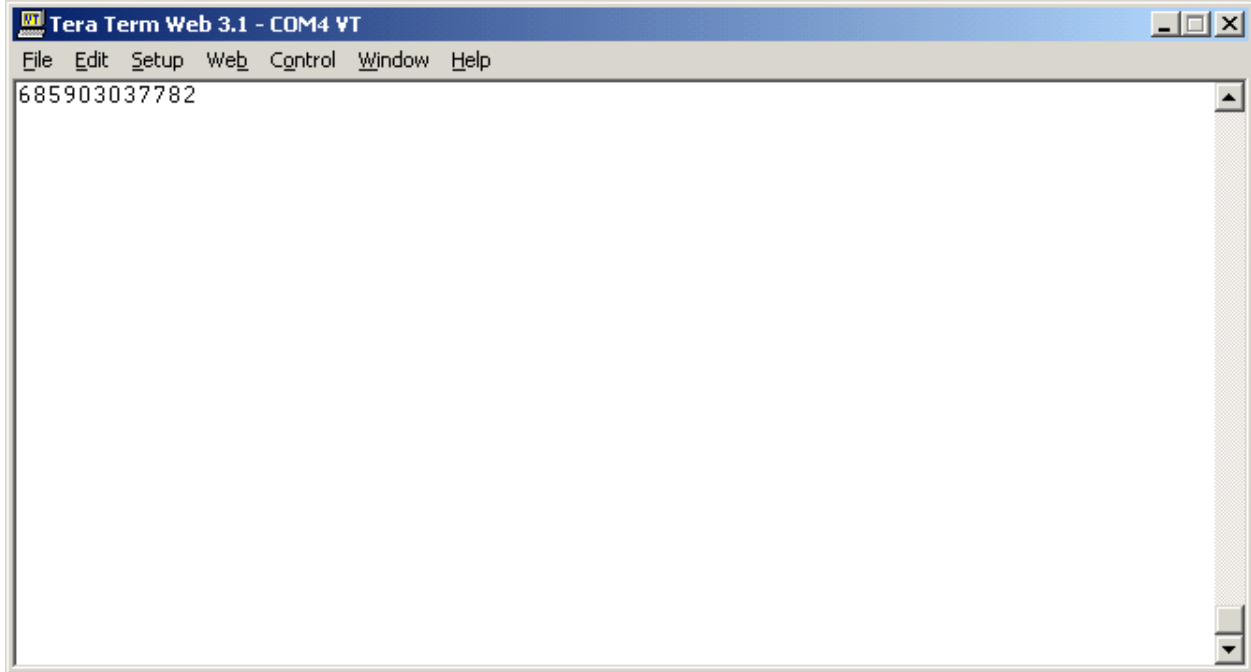

Figure 27 Tera Term Entry Screen

Beep on BELL Character

Parameter # 150

When this parameter is enabled, the RS6000 issues a beep when a <BEL> character is received over the SPP connection to the host device.

✓ **NOTE:** This parameter only applies to SPP (Serial Port Profile).

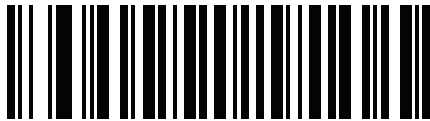

*Beep on <BEL> Enable

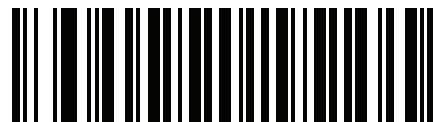

Beep on <BEL> Disable

Bell Indication Control

The BELL Indication Control parameter configures the beep tone sequence of the bell indication when a BELL character is received. This feature is valid only in SPP mode for PC connection.



GP_1_HI_SHORT



GP_2_HI_SHORT



GP_3_HI_SHORT



GP_4_HI_SHORT



GP_5_HI_SHORT



GP_1_LO_SHORT



GP_2_LO_SHORT



GP_3_LO_SHORT



GP_4_LO_SHORT



GP_5_LO_SHORT



GP_1_HI_LONG



GP_2_HI_LONG



GP_3_HI_LONG



GP_4_HI_LONG



GP_5_HI_LONG

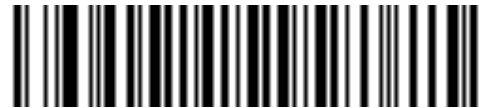

GP_1_LO_LONG

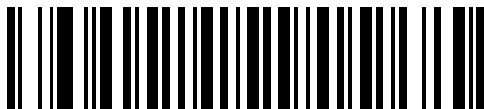

GP_2_LO_LONG



GP_3_LO_LONG

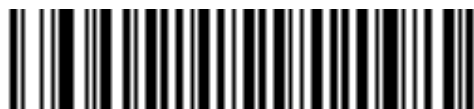

GP_4_LO_LONG

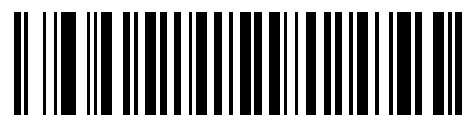

GP_5_LO_LONG



GP_FAST_WARBLE



GP_SLOW_WARBLE



GP_HI_LO



GP_LO_HI



GP_HI_LO_HI



GP_LO_HI_LO



GP_HI_HI_LO_LO



APP_ERROR_BEEP



APP_CLICK



LOW_CLICK

General Bluetooth Options

Discoverable Mode

Parameter # 610

Select a discoverable mode based on the device initiating discovery:

- Select **General Discoverable Mode** when initiating connection from a PC.
- Select **Limited Discoverable Mode** when initiating connection from a PC or mobile device, and the RS6000 does not appear in General Discoverable Mode. Note that it can take longer to discover the device in this mode.

The RS6000 remains in Limited Discoverable Mode for 30 seconds, and the blue LED flashes while in this mode. It is then non-discoverable. To re-active Limited Discoverable Mode, press the trigger.



***General Discoverable Mode
(0)**

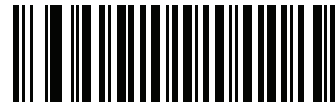

**Limited Discoverable Mode
(1)**

Bluetooth Security

The RS6000 supports Bluetooth authentication. Authentication can be requested by either the remote device or the RS6000.

✓ **NOTE:** A remote device can still request authentication.

PIN Code

Parameter # 552

✓ **NOTE:** The default PIN code is 12345.

To set and store a PIN code (e.g., password) on the RS6000 to connect to the host:

1. Scan the **Set & Store PIN Code** bar code below.
2. Scan five alphanumeric programming bar codes using the alphanumeric bar codes beginning on page [328](#).
3. Scan **End of Message** on page [336](#).

If the RS6000 communicates with a remote device with security enabled, synchronize the PIN codes on the RS6000 and remote device. To achieve this, connect the RS6000 to the host when setting the PIN codes. If the RS6000 is not connected to a host, the PIN code change only takes affect on the RS6000. If is required between the RS6000 and host, and the PIN codes do not match, pairing fails.

✓ **NOTE:** An extended 16 character PIN code is available for additional security with Open Bluetooth (SPP and HID).



Set and Store PIN Code

Variable PIN Code

Parameter # 608

When connecting to a host device with authentication enabled, scan **Static PIN Code** below to avoid entering the PIN code manually. The PIN stored in memory is used. Scan the **Variable PIN Code** below to manually enter a PIN code with each connection.

The default PIN code is the user-programmed PIN set and stored above. Typically, however, HID connections require entering a Variable PIN Code. If, when attempting connection, the application presents a text box that includes a PIN, scan the **Variable PIN Code** bar code, then re-attempt connection. When you hear a beep indicating the RS6000 is waiting for an alphanumeric entry, enter the provided variable PIN using the [Alphanumeric and Numeric Bar Codes on page 328](#), then scan **End of Message** on page 336 if the code is less than 16 characters. The RS6000 discards the variable PIN code after connection.



***Static PIN Code
(0)**



**Variable PIN Code
(1)**

Bluetooth Security Levels

Parameter # 1393

- **Low Bluetooth Security** - The low security setting is designed for ease of connection with most devices. This setting may be unacceptable to some devices. If connection fails, try re-connecting after increasing security setting on the RS6000.

If connecting to Bluetooth 2.1 device and above, Just Works method for secure and simple pairing is used.



NOTE: Data is encrypted using the **Low Bluetooth** security setting if connected to a Bluetooth 2.1 and above device.

- **Medium Bluetooth Security** - The medium security setting may require a passkey for the initial connection to pair RS6000 and device. If connecting to Bluetooth 2.1 device and above, *Passkey Entry* method for secure and simple pairing is used.
- **High Bluetooth Security** - The high security setting enables *Man in the Middle* protection for Bluetooth 2.1 and above. Not all devices are able to support this mode.
- **Legacy Bluetooth Security** (Bluetooth 2.0 and below) - The legacy security setting enables authentication and encryption for legacy pairing.

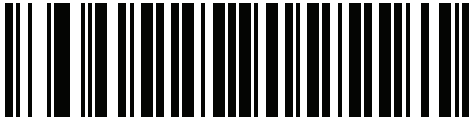

***Low Bluetooth Security**

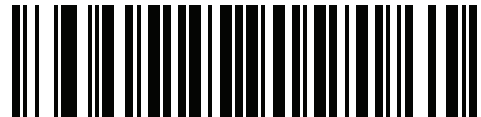

Medium Bluetooth Security

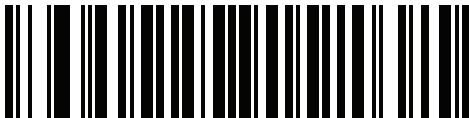

High Bluetooth Security

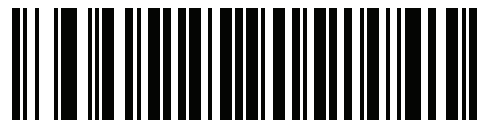

Legacy Bluetooth Security

Wi-Fi Friendly Mode

Scanners configured for Wi-Fi friendly mode behave as follows:

- The RS6000 remains in sniff mode, and exits sniff mode only during firmware update.
- If any Wi-Fi channel is excluded from the hopping sequence, AFH turns off.
- RS6000 avoid the selected Wi-Fi channels after establishing connection.

Notes

- If using this feature, configure all RS6000 in the area for Wi-Fi friendly mode.
- By default, no Wi-Fi channels are excluded.
- Since Bluetooth requires a minimum of 20 channels when Wi-Fi channels 1, 6, and 11 are excluded, a smaller number of channels are cut from the hopping sequence.
- Updating Wi-Fi friendly settings before Bluetooth connection is recommended.

Scan a bar code below to enable or disable **Wi-Fi Friendly Mode**, then see [Wi-Fi Friendly Channel Exclusion](#) to select any channels to exclude.

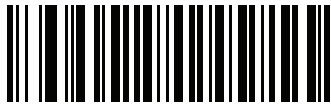

***Disable Wi-Fi Friendly Mode**



Enable Wi-Fi Friendly Mode

Wi-Fi Friendly Channel Exclusion

Select the channels to exclude:

- **Exclude Wi-Fi channel 1:** Bluetooth channels 0-21 are excluded from hopping sequence (2402-2423 MHz).
- **Exclude Wi-Fi channel 6:** Bluetooth channels 25-46 are excluded from hopping sequence (2427 - 2448 MHz).
- **Exclude Wi-Fi channel 11:** Bluetooth channels 50-71 are excluded from hopping sequence (2452 - 2473 MHz).
- **Exclude Wi-Fi channel 1, 6 and 11:** Bluetooth channels 2-19 (2404-2421 MHz), 26-45 (2428 - 2447 MHz) and 51-69 (2453 - 2471 MHz) are excluded from hopping sequence.
- **Exclude Wi-Fi channels 1 and 6:** Bluetooth channels 0-21 (2402-2423 MHz) and 25-46 (2427 - 2448 MHz) are excluded from hopping sequence.
- **Exclude Wi-Fi channels 1 and 11:** Bluetooth channels 0-21 (2402-2423 MHz) and 50-71 (2452 - 2473 MHz) are excluded from hopping sequence.
- **Exclude Wi-Fi channel 6 and 11:** Bluetooth channels 25-46 (2427 - 2448 MHz) and 50-71 (2452 - 2473 MHz) are excluded from hopping sequence.

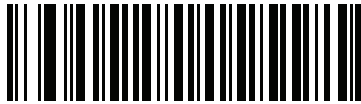

***Use All Channels (Standard AFH)**

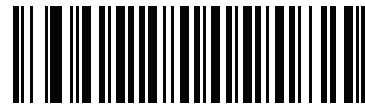

Exclude Wi-Fi Channel 1



Exclude Wi-Fi Channel 6



Exclude Wi-Fi Channel 11



Exclude Wi-Fi Channels 1, 6, and 11

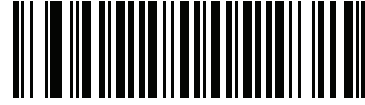

Exclude Wi-Fi Channels 1 and 6



Exclude Wi-Fi Channels 1 and 11

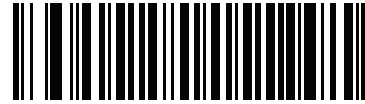

Exclude Wi-Fi Channels 6 and 11

Radio Output Power

Parameter # 1324

RS6000 uses a configurable radio which can be configured to operate in:

- Low power mode as a Class 2 device
- High power mode as Class 1 device.

Increase the radio output power to increase range. Scan a bar code to select the desired power mode.

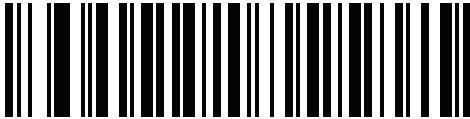

Class 1 (High Power)

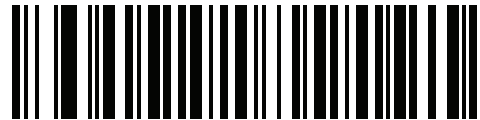

***Class 2 (Low Power)**

Link Supervision Timeout

Parameter # 1698

Link supervision timeout controls how quickly the RS6000 senses that the Bluetooth radio lost connection to the remote device. A lower value helps prevent data loss at the edge of the operating range while a larger value helps prevent disconnects due to the remote device not responding in time. If you are experiencing occasional disconnects and the RS6000 is able to reconnect, increase the link supervision timeout value.

✓ **NOTE:** The RS6000 only controls Link Supervision Timeout in Master mode.

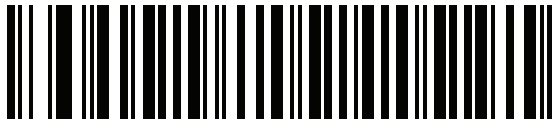

*0.5 Seconds

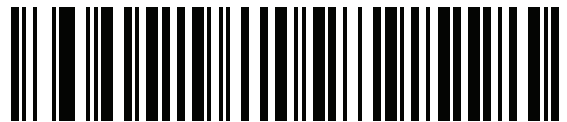

2 Seconds

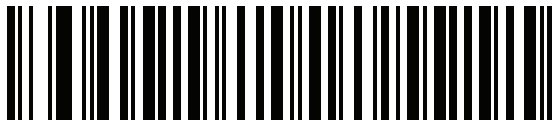

5 Seconds

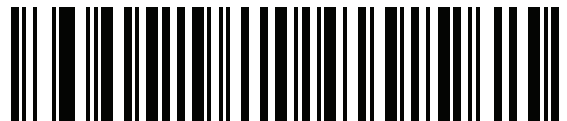

10 Seconds

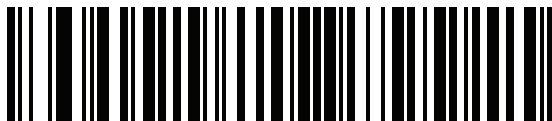

20 Seconds

Reconnecting

When in SPP Master, SSI Bluetooth Classic, and Bluetooth HID, the RS6000 automatically tries to reconnect to a remote device when a disconnection occurs that is due to the radio losing communication. This can happen if the RS6000 goes out of range with the remote device, or if the remote device powers down. The RS6000 initiates auto-reconnect based the Auto-Reconnect setting. The duration of the auto-reconnect attempt is specified by the Reconnect Attempt Interval setting. During reconnection, the Status LED blinks blue.

If the auto-reconnect process fails due to:

- Page Time-Outs - The RS6000 sounds a page timeout beep (long low/long high) and enters low power mode.
- Connection Attempt Rejected - The RS6000 sounds a connection reject beep sequence (see [Status LED Indications on page 19](#)) and enters low power mode.



NOTE: If a bar code is scanned while the auto-reconnect sequence is in process, a transmission error beep sequence sounds and the data is not transmitted to the host. After a connection is reestablished, normal scanning operation returns.

Switching between Bluetooth host types by scanning a host type bar code causes the radio to be reset. Scanning is disabled during this time. It takes several seconds for the RS6000 to re-initialize the radio at which time scanning is enabled.

Restore Lost Bluetooth Connection

If the auto-reconnect process fails and times out, the Bluetooth connection is re-established as follows:

1. Ensure that the RS6000 is within a range of 10 meters (30 feet) from the mobile computer.
2. Ensure that the mobile computer is on and “awake” (not in Suspend mode).
3. Briefly press the Restore Key on the RS6000 to initiate the reconnect process.
4. The Status LED starts flashing blue indicating that the RS6000 is attempting to establish connection with a mobile computer. The Status LED turns off and the RS6000 emits one string of low/high beeps indicating that the RS6000 is connected and ready for scanning.

Reconnect Attempt Beep Feedback

Parameter # 559

When the RS6000 disconnects as it goes out of range, it immediately attempts to reconnect. While the RS6000 attempts to reconnect, the Status LED continues to blink blue. If the auto-reconnect process fails, the RS6000 emits a page timeout beep (long low/long high) and the Status LED stops blinking. The process can be restarted by pulling the trigger or pressing the restore key.

The Beep on Reconnect Attempt feature is disabled by default. When enabled, the RS6000 emits five short high beeps every five seconds while the re-connection attempt is in progress. Scan a bar code below to enable or disable Beep on Reconnect Attempt.



***Disable Beep on Reconnect Attempt
(0)**



**Enable Beep on Reconnect Attempt
(1)**

Reconnect Attempt Interval

Parameter # 558

When a RS6000 disconnects as it goes out of range, it immediately attempts to reconnect for the default time interval of 30 seconds. This time interval can be changed to one of the options below.

To set the Reconnect Attempt Interval, scan one of the bar codes below.



***Attempt to Reconnect for 30 Seconds
(6)**



**Attempt to Reconnect for 1 Minute
(12)**



**Attempt to Reconnect for 5 Minutes
(60)**



**Attempt to Reconnect for 30 Minutes
(360)**



Attempt to Reconnect for 1 Hour
(720)



Attempt to Reconnect Indefinitely
(0)

Auto-reconnect

Parameter # 604

In Bluetooth Keyboard Emulation (HID) mode, SPP Master, and SSI Bluetooth Classic, select a re-connect option for when the RS6000 loses its connection with a remote device:

- **Auto-reconnect on Bar Code Data:** The RS6000 auto-reconnects when you scan a bar code. With this option, a delay can occur when transmitting the first characters. The RS6000 sounds a decode beep upon bar code scan, followed by a connection, a page timeout, a rejection beep, or a transmission error beep. Select this option to optimize battery life on the RS6000 and mobile device. Note that auto-reconnect does not occur on rejection commands.
- **Auto-reconnect Immediately:** When the RS6000 loses connection, it attempts to reconnect. If a page timeout occurs, the RS6000 attempts reconnect by pulling the trigger or pressing the restore key. Select this option if the RS6000 battery life is not an issue and you do not want a delay to occur when the first bar code is transmitted. Note that auto-reconnect does not occur on rejection commands.
- **Disable Auto-reconnect:** When the RS6000 loses connection, you must re-establish it manually.



Auto-reconnect on Bar Code Data
(1)

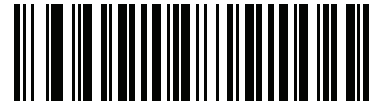

***Auto-reconnect Immediately**
(2)

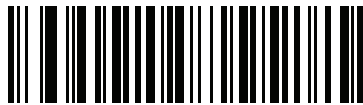

Disable Auto-reconnect
(0)

Bluetooth Disconnection Alert Control

Bluetooth Disconnect Indication

When this parameter is enabled, the RS6000 plays a beep every 10 seconds when the RS6000 Bluetooth is disconnected.



*Disable



Enable

Bluetooth Disconnect Indication After Battery Insert

Time delay for Bluetooth disconnect indication after battery installed.



60 Seconds



*120 Seconds



180 Seconds



240 Seconds



300 Seconds

Bluetooth Disconnect Indication After Bluetooth Disconnection

Time delay for Bluetooth disconnect indication after Bluetooth disconnection.



***30 Seconds**



60 Seconds



90 Seconds



120 Seconds

Bluetooth Disconnect Indication - Cycle Time

Sets the period of Bluetooth disconnect indication.

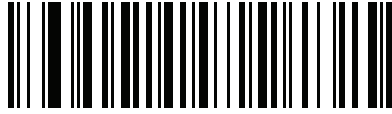

***10 Seconds**



30 Seconds

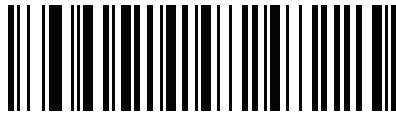

60 Seconds

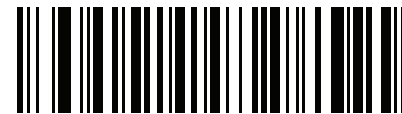

90 Seconds

Bluetooth Disconnect Indication - Beep Type



***3 High/Short Beeps**



3 Low/Short Beeps



3 High/Long beeps



High/Low/High Beep

Pairing Support

Toggle Pairing

Parameter # 1322

If the RS6000 is configured for Toggle Pairing, scanning a pairing bar code a second time will unpair the scanner.

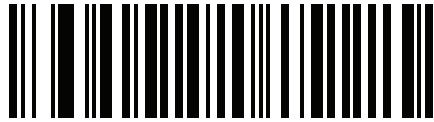

***Toggle Pairing Disable**

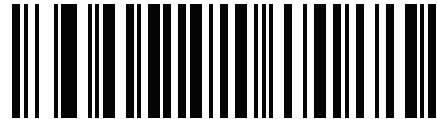

Toggle Pairing Enable

Force Pairing Save

The Force Pairing Save parameter enables/disables saving the remote Bluetooth address after each Bluetooth connection attempt.

When this parameter is disabled, the Bluetooth address is saved only after a successful Bluetooth connection. If the Bluetooth connection fails, the Bluetooth address is not saved.



NOTE: This parameter is effective when the RS6000 connects as Master.



Disable



***Enable**

Auto Un-Pairing

Parameter # 1708

The auto un-pair parameter configures the RS6000 to un-pair from the host computer on specific events.

- **Disable (default)** - the RS6000 will not auto un-pair on any events.
- **On cradle insertion** - the RS6000 will un-pair when inserted charging cradle
- **On reset** - the RS6000 will un-pair if a warm or cold reset occurs
- **On cradle or reset** - the RS6000 will un-pair on cradle insertion or reset event.



*Disable



Un-pair on Cradle Insertion



On Reset

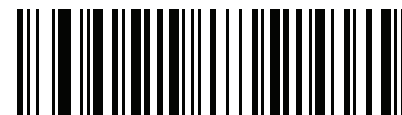

On Cradle or Reset

Pairing Bar Code Format

When pairing the RS6000 to certain host devices in SSI Bluetooth Classic, SPP Bluetooth Master or Bluetooth HID, it is necessary to create a pairing bar code. The RS6000 scans the pairing bar code and initiates the connection to the host computer. To create a pairing bar code label, the Bluetooth address of the remote device must be known (refer to the mobile computer user guide).

Pairing bar codes are Code 128 or Data Matrix symbologies formatted as follows:

<Fnc 3>Bxxxxxxxxxxxx

where:

- **B** (or **LNKB**) is the prefix
- xxxxxxxxxxxx represents the 12-character Bluetooth address.

Pairing Bar Code Example

If the mobile computer Bluetooth address is 11:22:33:44:55:66, then the pairing bar code is:



Figure 28 Creating a Pairing Bluetooth Bar Code

Unpairing

Unpair the RS6000 from the host computer to make the host computer available for pairing with another RS6000. Scan the bar code below to disconnect the RS6000 from its host computer.



Unpairing

Batch Mode

Parameter # 544



IMPORTANT: Batch mode only applies for HID and SPP Master Mode.

The RS6000 supports five versions of batch mode. When the RS6000 is configured for any of the batch modes, it attempts to store bar code data (not parameter bar codes) until transmission is initialized, or the maximum number of bar codes are stored. When a bar code is saved successfully, a good decode beep sounds and the LED flashes green. If the RS6000 is unable to store a new bar code, a low/high/low/high out of memory beep sounds. (See page 19 for all beeper and LED definitions.)

In all modes, calculate the amount of data (number of bar codes) the RS6000 can store as follows:

$$\text{Number of storable bar codes} = 9,000 \text{ bytes of memory} / (\text{number of characters in the bar code} + 3).$$

- ✓ **NOTE:** If the batch mode selection is changed while there is batched data, the new batch mode takes effect only after all the previously batched data is sent.

Modes of Operation

- **Normal (default)** - Do not batch data. The RS6000 attempts to transmit every scanned bar code.
- **Out of Range Batch Mode** - The RS6000 starts storing bar code data when it loses its connection to a remote device (for example, when a user holding the RS6000 walks out of range). Data transmission is triggered by re-establishing the connection with the remote device (for example, when a user holding the RS6000 walks back into range).
- **Standard Batch Mode** - The RS6000 starts storing bar code data after **Enter Batch Mode** is scanned. Data transmission is triggered by scanning **Send Batch Data**.

- ✓ **NOTE:** Transmission is halted if the connection to the remote device is lost.

In all modes, transmissions are halted if the RS6000 is moved out of range. The RS6000 resumes when it is back in range. If a bar code is scanned while batch data is transmitted it is appended to the end of the batched data; parameter bar codes are not stored.



*Normal
(00h)



Out of Range Batch Mode
(01h)



**Standard Batch Mode
(02h)**



Enter Batch Mode



Send Batch Data

Accessories

Accessories

Table 6 Accessories

Accessory	Part Number	Description
Cradles		
1-Slot RS6000 USB Charging Cradle	CRD-NGRS-1S1BU-01	Provides RS6000 and spare battery charging and USB communication with a host computer. Use with power supply, p/n PWRS-14000-148R and country specific grounded AC line cord.
2-Slot WT6000/RS6000 USB Charging Cradle	CRD-NWTRS-2SUCH-01	Provides WT6000 and RS6000 charging and USB communication with a host computer. Use with power supply, p/n PWRS-14000-148R and country specific grounded AC line cord.
5-Slot RS6000 Charge Only Cradle	CRD-NGRS-5S5BC-01	Charges up to five RS6000 devices and five spare batteries. Use with power supply, p/n PWRS-14000-241R, DC line cord, p/n 50-16002-029R and country specific grounded AC line cord.
10-Slot WT6000/RS6000 Charge Only Cradle	CRD-NWTRS-10SCH-01	Charges up to five WT6000 devices and up to five RS6000 scanners. Use with power supply, p/n PWRS-14000-241R, DC line cord, p/n 50-16002-029R and country specific grounded AC line cord.
10-Slot RS6000 Charge Only Cradle	CRD-NGRS-10SCH-01	Charges up to 10 RS6000 devices. Use with power supply, p/n PWRS-14000-241R, DC line cord, p/n 50-16002-029R and country specific grounded AC line cord.
Batteries and Chargers		
Replacement Battery	BTRY-NWTRS-33MA-01	Replacement battery for WT6000 and RS6000 (single pack).
4-Slot Battery Charger	SAC-NWTRS-4SCH-01	Charges up to four spare batteries. Requires power supply, p/n PWRS-14000-148R and country specific grounded AC line cord.

Accessories

Table 6 Accessories (Continued)

Accessory	Part Number	Description
20-Slot Battery Charger	SAC-NWTRS-20SCH-01	Charges up to 20 spare batteries. Use with power supply, p/n PWRS-14000-241R, DC line cord, p/n 50-16002-029R and country specific grounded AC line cord.
Mounting Brackets		
Rack Mount Bracket	BRKT-SCRD-SMRK-01	Use for mounting a 5-Slot cradle or four 4-Slot Battery Chargers on a rack.
Cables		
2-Way DC Cable	25-122026-02R	
4-Way DC Cable	25-85992-01R	
DC Y Cable	25-85993-01R	Provides power from the PWRS-14000-241R power supply to two 4-Slot Battery Chargers.
DC Line Cord	50-16002-029R	Provides power from the power supply to the 5-Slot Charge Only Cradle, and the 5-Slot Charge Only Cradle with Battery Charge.
Micro-USB to USB Cable	25-124330-01R	Provides USB communication from a 1-Slot RS6000 USB Charging Cradle or 2-Slot WT6000/RS6000 USB Charging Cradle to a host computer.
Power Supplies		
Power Supply	PWRS-14000-148R	Provides power to the 2-Slot cradles and 4-Slot Spare Battery Charger. Requires country specific grounded AC line cord.
Power Supply	PWRS-14000-241R	Provides power to the 5-Slot Charge Only Cradle, and the 5-Slot Charge Only Cradle with Battery Charger. Requires DC Line Cord, p/n 50-16002-029R and country specific grounded AC line cord.
Soft Goods		
RS6000 Spare Hook and Loop Finger Straps	SG-NGRS-STRPK-10	Replacement hook and loop finger strap for triggered configuration (10-pack).
RS6000 Spare Nylon Finger Straps	SG-NGRS-STRPNY-10	Replacement nylon finger strap for triggered configuration with cam buckle (10-pack).
RS6000 Spare Triggerless Finger Straps	SG-NGRS-STRPK2-10	Replacement hook and loop finger strap for triggerless configuration (10-pack).
RS6000 Spare Strap Buckles	SG-NGRS-STBKL-10	Replacement strap buckles (10-pack).
RS6000 Spare Hook and Loop Trigger Assembly	SG-NGRS-TRGA-01	Replacement trigger assembly. Use with Hook and Loop straps.
RS6000 Spare Trigger Assembly with Cam Buckle	SG-NGRS-TRGA-02	Replacement trigger assembly with cam buckle. Use with nylon straps.

Table 6 Accessories (Continued)

Accessory	Part Number	Description
RS6000 Spare Comfort Pad	SG-NGRS-CMPD-01	Replacement comfort pad.
RS6000 Spare Triggerless Strap Holder	SG-NGRS-TRLH-01	Replacement strap holder.

1-Slot RS6000 USB Charging Cradle

- ✓ **NOTE:** Ensure that you follow the guidelines for battery safety described in [Battery Safety Guidelines on page 281](#).

The 1-Slot RS6000 USB Charging Cradle:

- provides 5 VDC (nominal) power for operating the RS6000
- provides USB communication with a host computer
- charges a spare battery.

Figure 29 1-Slot RS6000 USB Charging Cradle

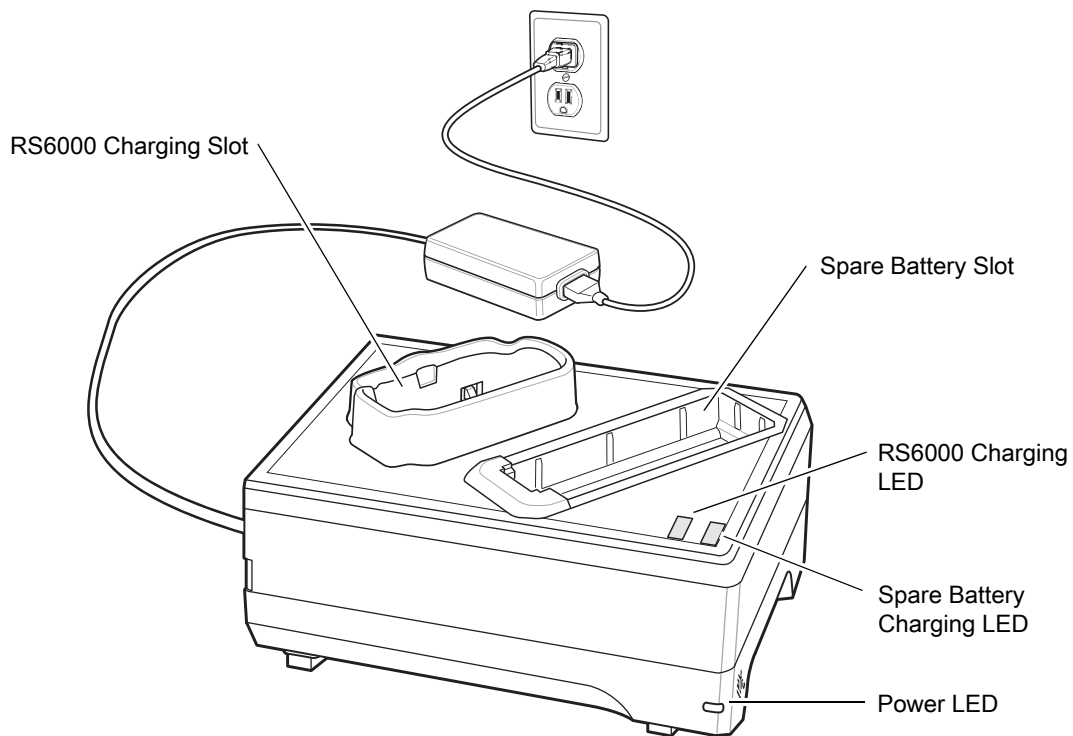
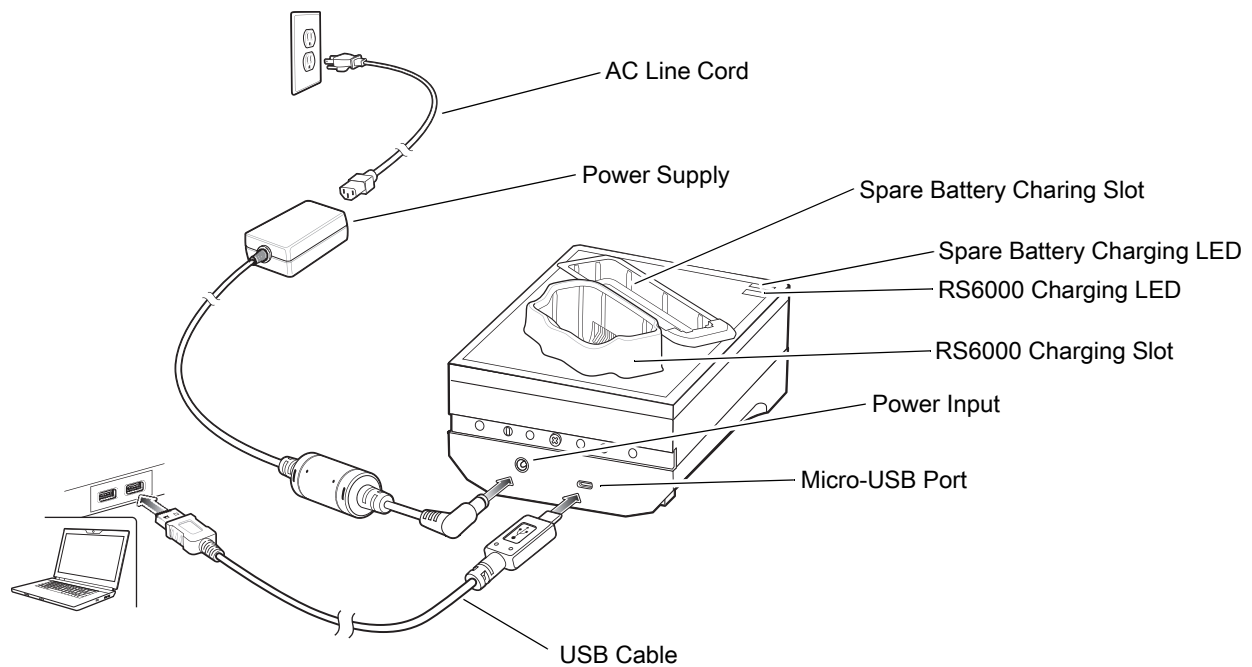

Figure 30 1-Slot RS6000 Charging Cradle Setup



Charging the RS6000

1. Insert the RS6000 into the RS6000 charging slot.

Figure 31 Insert RS6000 into Cradle

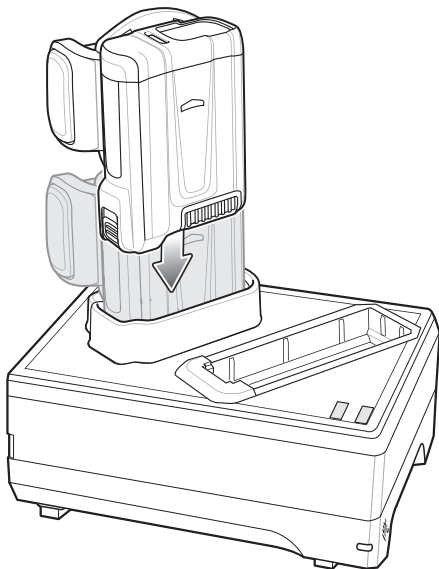

2. Ensure the RS6000 is seated properly. The RS6000 Charging LED blinks indicating charging.

Charging the Spare Battery

1. Insert a spare battery into the spare battery slot.

Figure 32 Insert Battery into Cradle

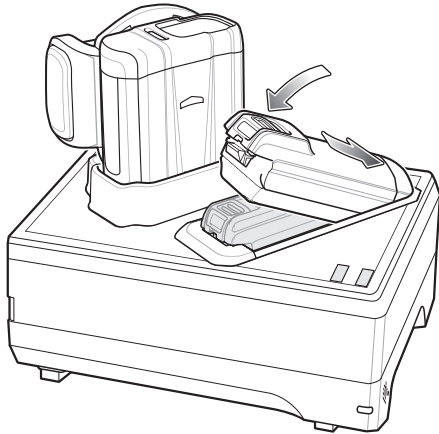

2. Ensure the battery is seated properly. The Spare Battery Charging LED blinks indicating charging.

Battery Charging

The RS6000 Charging LED indicates the charging status of the battery in the RS6000 and the Spare Battery Charging LED indicates the charging status of the spare battery. See [Table 7 on page 86](#). The 3,350 mAh battery fully charges in less than four hours at room temperature.

Table 7 Charging LED Indicators

State	Indication
Off	The battery is not charging. The battery is not inserted correctly in the cradle or connected to a power source. Cradle is not powered.
Solid Amber	Battery is charging.
Solid Green	Battery charging is complete.
Fast Blinking Red (2 blinks/second)	Charging error, e.g.: - Temperature is too low or too high. - Charging has gone on too long without completion (typically eight hours).
Solid Red	Unhealthy battery is charging or fully charged.

Charge batteries in temperatures from 0 °C to 40 °C (32 °F to 104 °F). The device and cradle monitor the battery temperature. Battery charging is only performed when the battery is within safe charging temperature limits. At higher temperatures (e.g. approximately +35 °C (+95 °F)) the device or charging cradle may for small periods of time alternately enable and disable battery charging to keep the battery at acceptable temperatures. This process may require additional time to complete a full charge cycle. The cradle indicates when charging is disabled due to abnormal temperatures via the Status LED.

2-Slot WT6000/RS6000 USB Charging Cradle

- ✓ **NOTE:** Ensure that you follow the guidelines for battery safety described in [Battery Safety Guidelines on page 281](#).

The 2-Slot WT6000/RS6000 Charging Cradle:

- provides 5.4 VDC (nominal) power for operating the WT6000 and RS6000.
- provides USB communication with a host computer.

Figure 33 2-Slot WT6000/RS6000 Charging Cradle

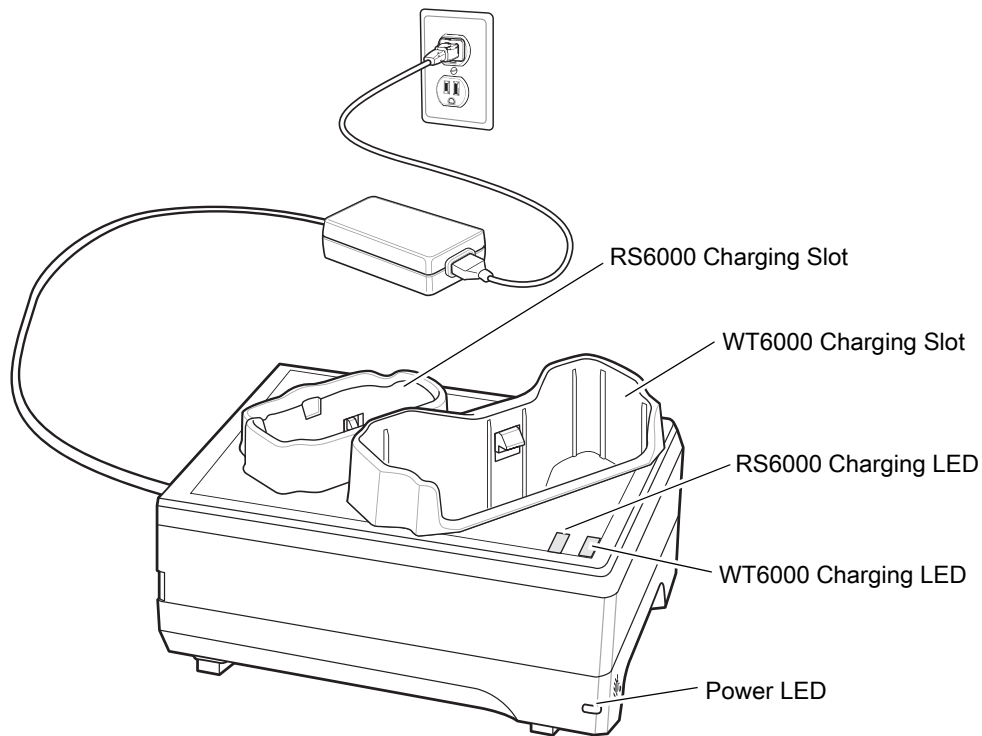
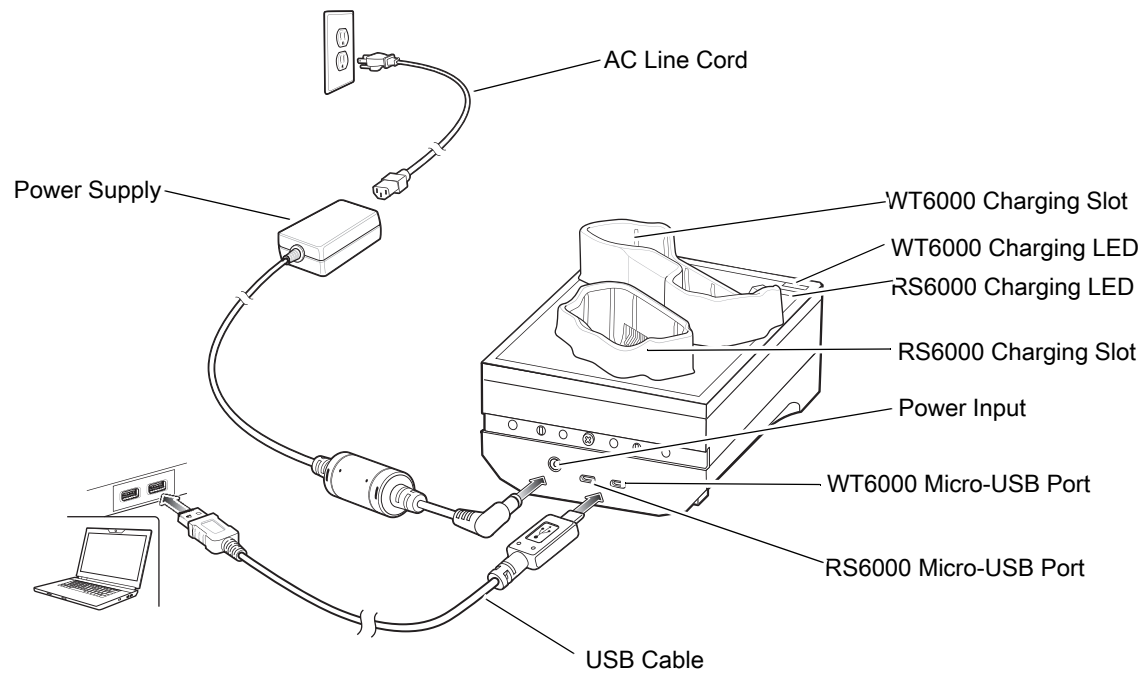

Figure 34 2-Slot WT6000/RS6000 Charging Cradle Setup



Charging the WT6000

1. Insert the WT6000 into the WT6000 charging slot.

Figure 35 Insert WT6000 into Cradle

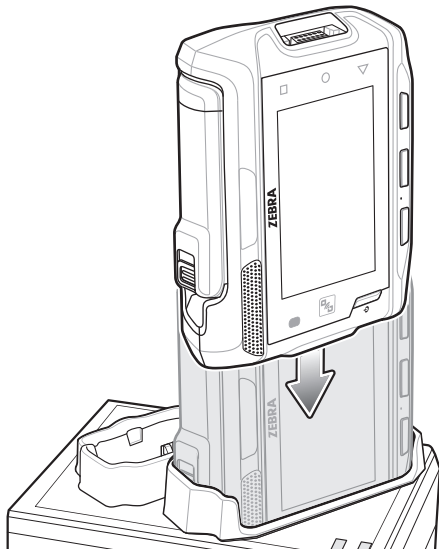

2. Ensure the WT6000 is seated properly. The WT6000 Charging LED blinks indicating charging.

Charging the RS6000

1. Insert the RS6000 into the RS6000 charging slot.

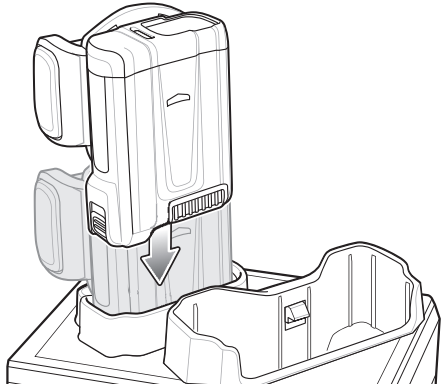
Figure 36 Insert RS6000 into Cradle

2. Ensure the RS6000 is seated properly. The RS6000 Charging LED blinks indicating charging.

Battery Charging

The WT6000 Charging LED indicates the charging status of the battery in the WT6000 and the RS6000 Charging LED indicates the charging status of the battery in the RS6000. See [Table 7 on page 86](#). The 3,350 mAh battery fully charges in less than four hours at room temperature.

Charge batteries in temperatures from 0 °C to 40 °C (32 °F to 104 °F). The device and cradle monitor the battery temperature. Battery charging is only performed when the battery is within safe charging temperature limits. At higher temperatures (e.g. approximately +35 °C (+95 °F)) the device or charging cradle may for small periods of time alternately enable and disable battery charging to keep the battery at acceptable temperatures. This process may require additional time to complete a full charge cycle. The cradle indicates when charging is disabled due to abnormal temperatures via the Status LED.

5-Slot RS6000 Charge Only Cradle

- ✓ **NOTE:** Ensure that you follow the guidelines for battery safety described in [Battery Safety Guidelines on page 281](#).

The 5-Slot Charge Only Cradle:

- Provides 5.4 VDC (nominal) power for operating the RS6000.
- Simultaneously charges up to five RS6000 devices.
- Simultaneously charges up to five spare batteries.

Figure 37 5-Slot RS6000 Charge Only Cradle

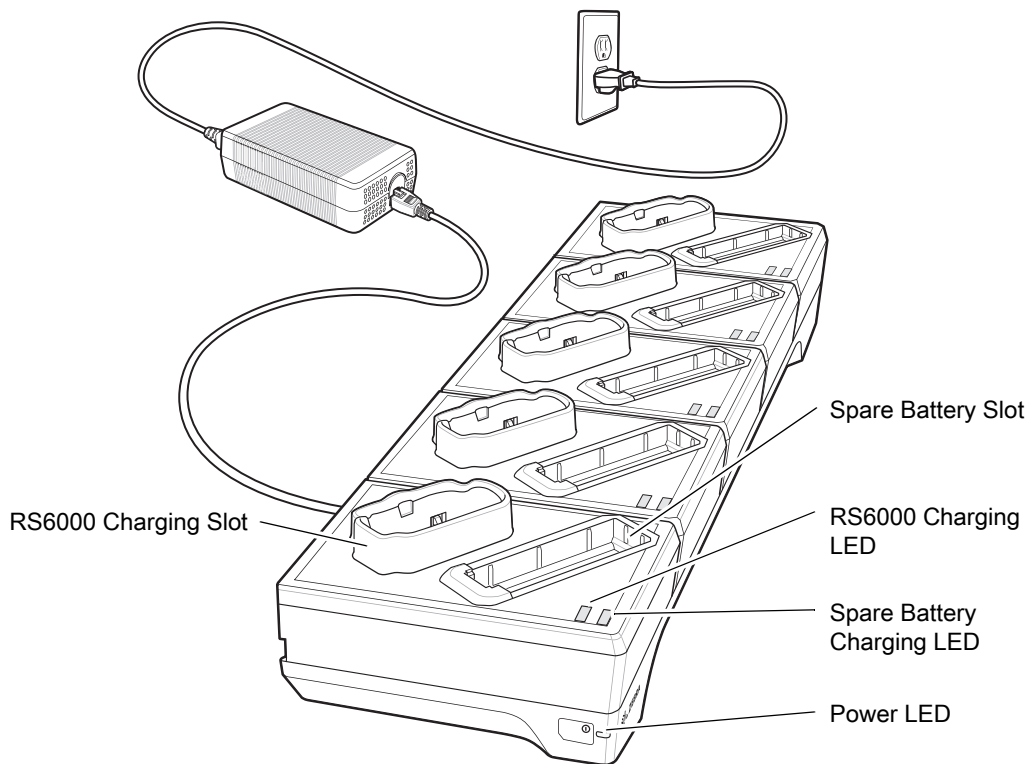
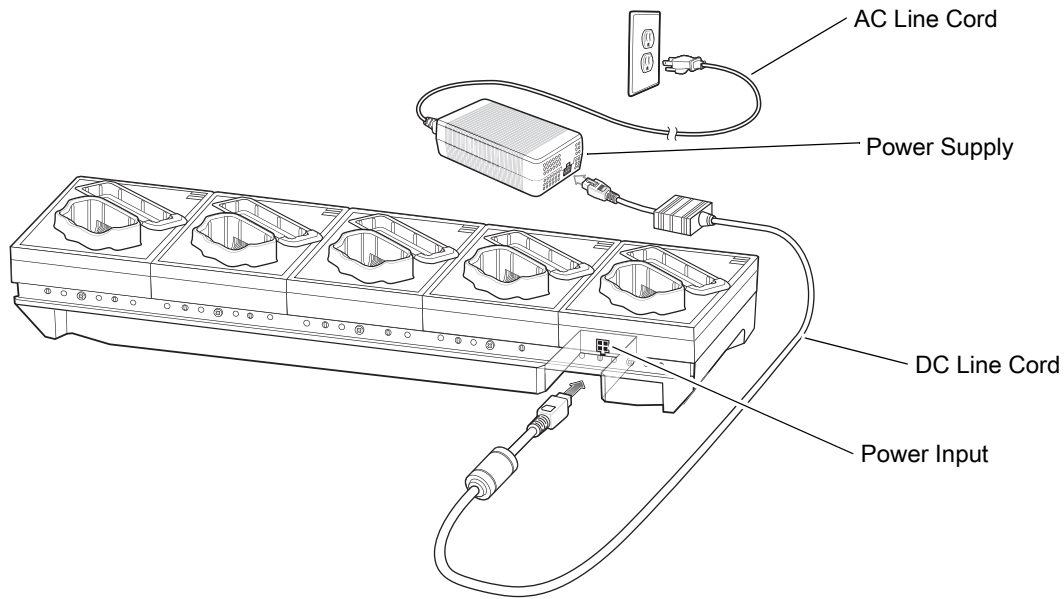

Figure 38 5-Slot RS6000 Charge Only Cradle Setup



Charging the RS6000

To Charge the RS6000:

1. Insert the RS6000 into the RS6000 charging slot.

Figure 39 Insert RS6000 into Cradle

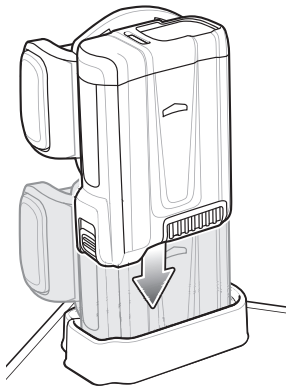

2. Ensure that the RS6000 is properly seated in the charging slot.

Charging the Spare Battery

1. Insert a spare battery into the spare battery slot.

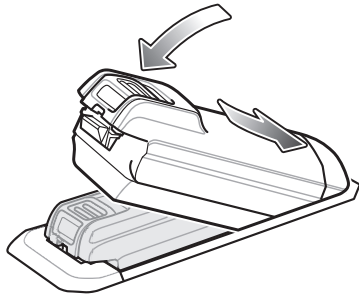
Figure 40 Insert Battery into Cradle

2. Ensure the battery is seated properly. The Spare Battery Charging LED blinks indicating charging.

Battery Charging

The RS6000 Charging LED indicates the charging status of the battery in the RS6000 and the Spare Battery Charging LED indicates the charging status of the spare battery. See [Table 7 on page 86](#). The 3,350 mAh battery fully charges in less than four hours at room temperature.

Charge batteries in temperatures from 0 °C to 40 °C (32 °F to 104 °F). The device and cradle monitor the battery temperature. Battery charging is only performed when the battery is within safe charging temperature limits. At higher temperatures (e.g. approximately +35 °C (+95 °F)) the device or charging cradle may for small periods of time alternately enable and disable battery charging to keep the battery at acceptable temperatures. This process may require additional time to complete a full charge cycle. The cradle indicates when charging is disabled due to abnormal temperatures via the Status LED.

10-Slot WT6000/RS6000 Charge Only Cradle

- ✓ **NOTE:** Ensure that you follow the guidelines for battery safety described in [Battery Safety Guidelines on page 281](#).

The 10-Slot Charge Only Cradle:

- Provides 5.4 VDC (nominal) power for operating the WT6000 and RS6000.
- Simultaneously charges up to five WT6000 devices.
- Simultaneously charges up to five RS6000 devices.

Figure 41 10-Slot WT6000/RS6000 Charge Only Cradle

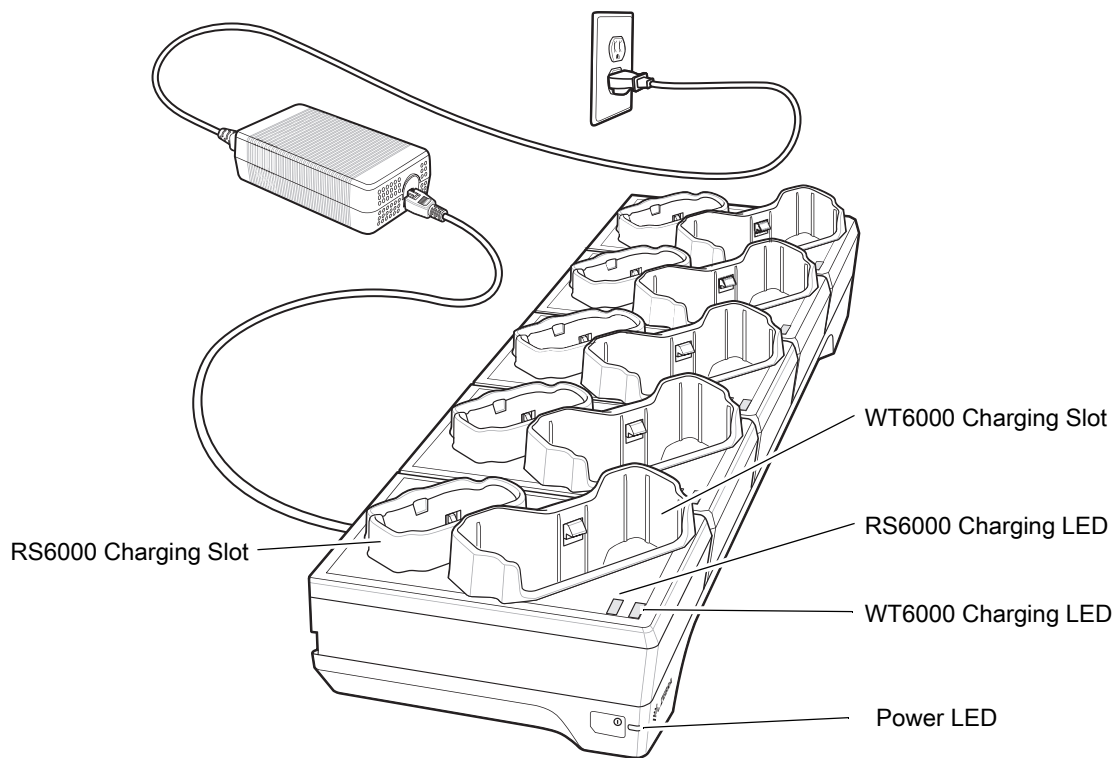
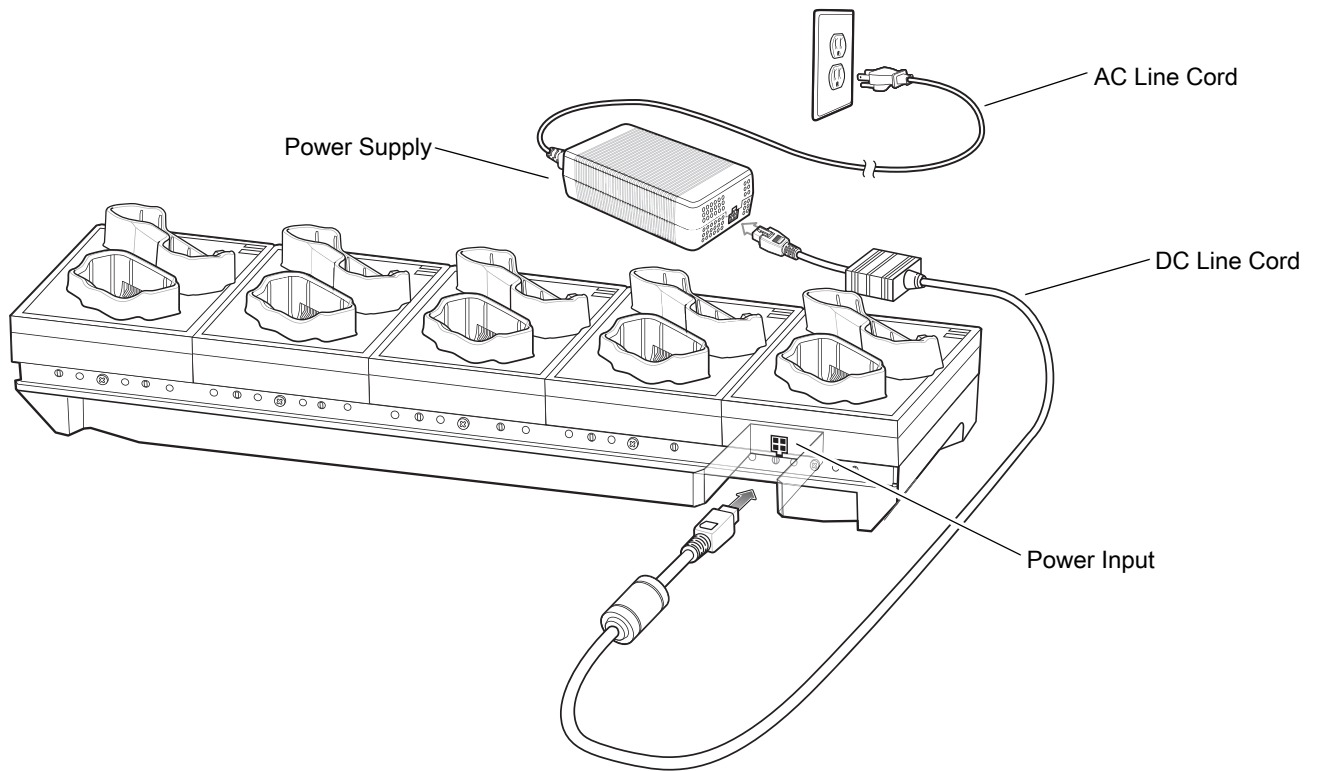

Figure 42 10-Slot WT6000/RS6000 Charge Only Cradle Setup



Charging the WT6000

To Charge the WT6000:

1. Insert the WT6000 in the WT6000 charging slot.

Figure 43 Insert WT6000 into Cradle

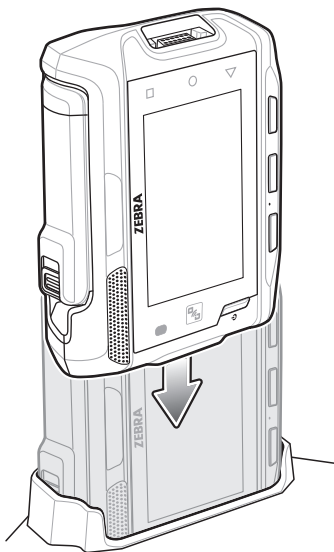

2. Ensure that the WT6000 is properly seated in the charging slot.

Charging the RS6000

To Charge the RS6000:

1. Insert the RS6000 in the RS6000 charging slot.

Figure 44 Insert RS6000 into Cradle

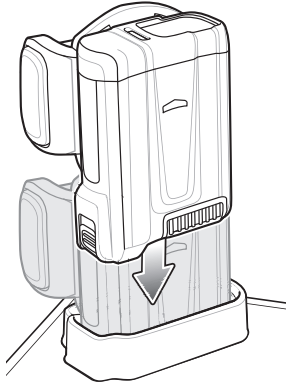

2. Ensure that the RS6000 is properly seated in the charging slot.

Battery Charging

The WT6000 Charging LED indicates the charging status of the battery in the WT6000 and the RS6000 Charging LED indicates the charging status of the battery in the RS6000. See [Table 7 on page 86](#). The 3,350 mAh battery fully charges in less than four hours at room temperature.

Charge batteries in temperatures from 0 °C to 40 °C (32 °F to 104 °F). The device and cradle monitor the battery temperature. Battery charging is only performed when the battery is within safe charging temperature limits. At higher temperatures (e.g. approximately +35 °C (+95 °F)) the device or charging cradle may for small periods of time alternately enable and disable battery charging to keep the battery at acceptable temperatures. This process may require additional time to complete a full charge cycle. The cradle indicates when charging is disabled due to abnormal temperatures via the Status LED.

10-Slot RS6000 Charge Only Cradle

- ✓ **NOTE:** Ensure that you follow the guidelines for battery safety described in [Battery Safety Guidelines on page 281](#).

The 10-Slot RS6000 Charge Only Cradle:

- Provides 5.4 VDC (nominal) power for operating the RS6000.
- Simultaneously charges up to 10 RS6000 devices.

Figure 45 10-Slot RS6000 Charge Only Cradle

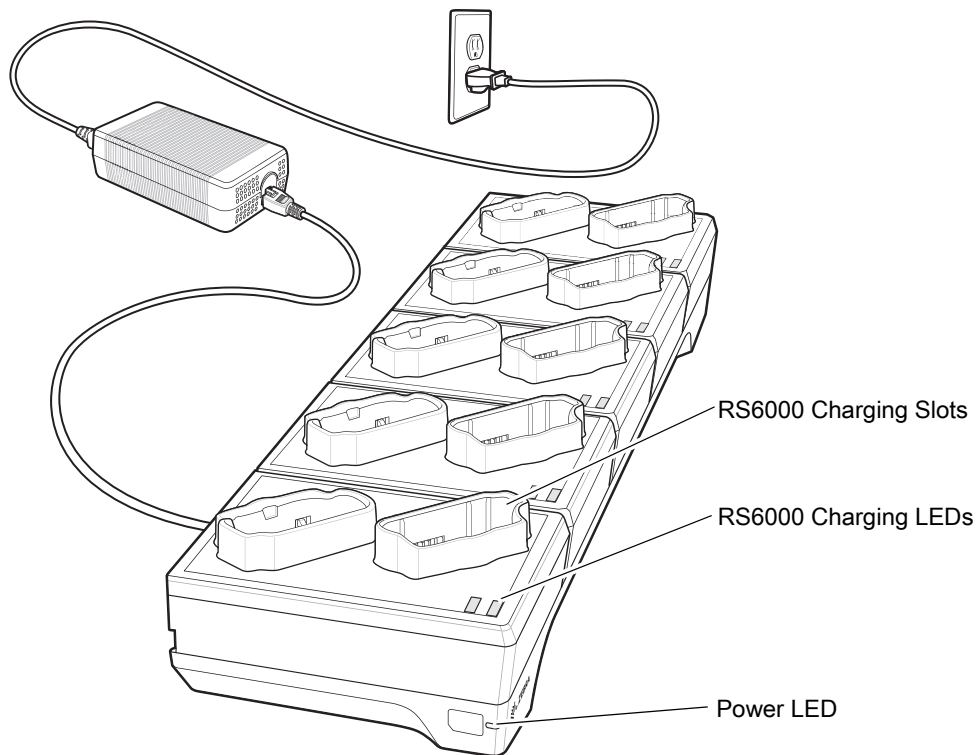
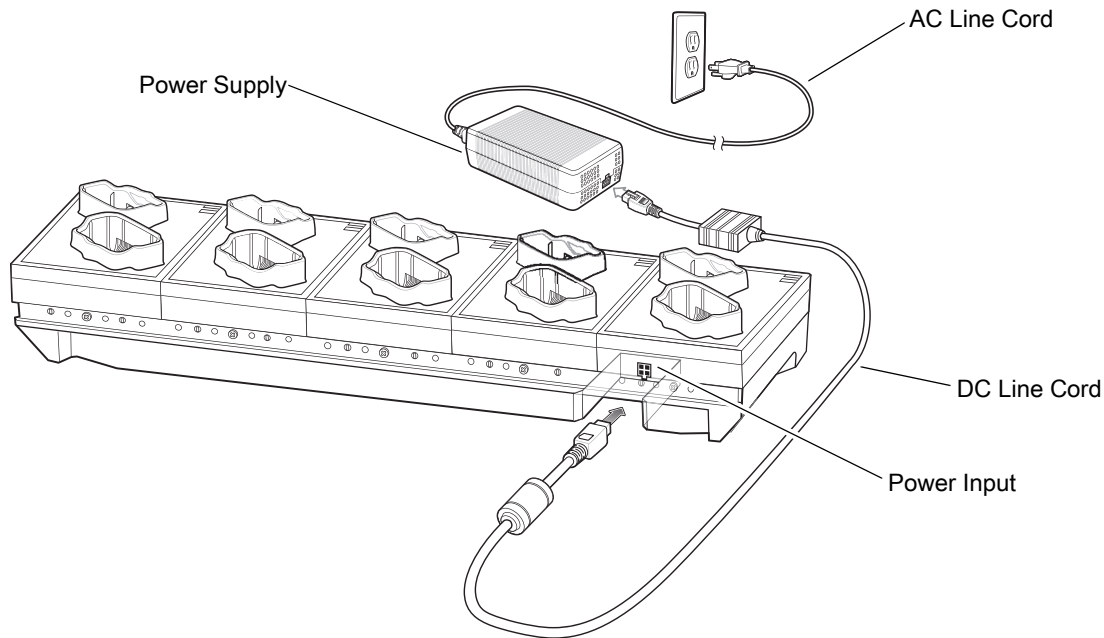

Figure 46 10-Slot RS6000 Charge Only Cradle Setup



Charging the RS6000

To charge the RS6000:

1. Insert the RS6000 in the charging slot.

Figure 47 Insert RS6000 into Cradle

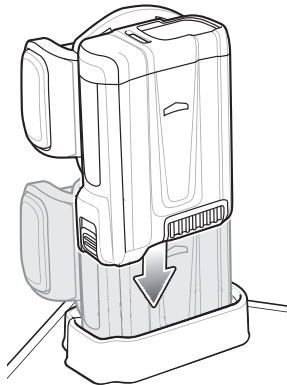

2. Ensure that the RS6000 is properly seated in the charging slot.

Battery Charging

The RS6000 Charging LED indicates the charging status of the battery in the RS6000. See [Table 7 on page 86](#). The 3,350 mAh battery fully charges in less than four hours at room temperature.

Charge batteries in temperatures from 0 °C to 40 °C (32 °F to 104 °F). The device and cradle monitor the battery temperature. Battery charging is only performed when the battery is within safe charging temperature limits. At higher temperatures (e.g. approximately +35 °C (+95 °F)) the device or charging cradle may for small periods of time alternately enable and disable battery charging to keep the battery at acceptable temperatures. This process may require additional time to complete a full charge cycle. The cradle indicates when charging is disabled due to abnormal temperatures via the Status LED.

4-Slot Battery Charger

✓ **NOTE:** Ensure that you follow the guidelines for battery safety described in [Battery Safety Guidelines on page 281](#).

The 4-Slot Battery Charger charges up to four spare batteries.

Figure 48 4-Slot Battery Charger

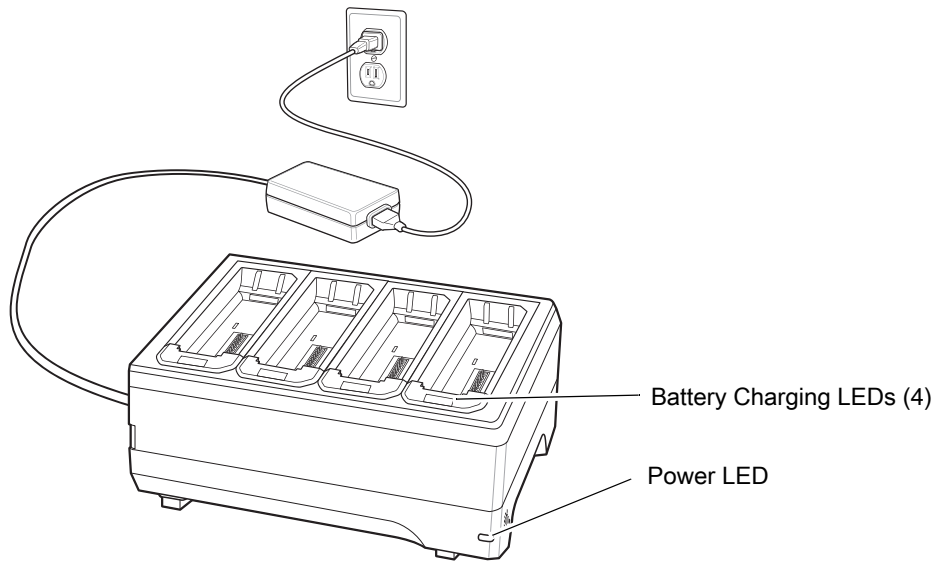
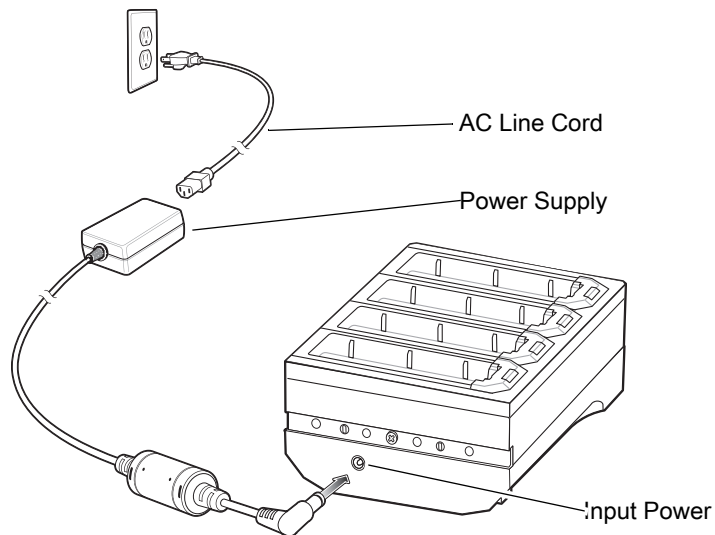

Figure 49 Four Slot Battery Charger Power Setup



Battery Installation

To install the battery:

1. Insert the battery into a battery slot.
2. Gently press down on the battery until it snaps into place.

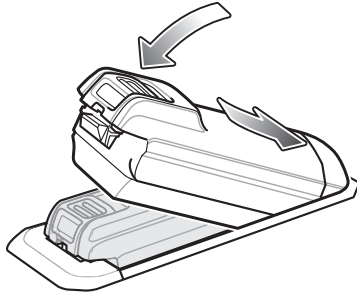
Figure 50 Insert Battery into Slot

Battery Removal

To remove the battery, press the latch and lift the battery out of the battery slot.

Battery Charging

Spare Battery Charging

Each Battery Charging LED indicates the status of the battery charging in each slot. See [Table 7 on page 86](#). The 3,350 mAh battery fully charges in less than four hours at room temperature.

Charge batteries in temperatures from 0 °C to 40 °C (32 °F to 104 °F). The device and cradle monitor the battery temperature. Battery charging is only performed when the battery is within safe charging temperature limits. At higher temperatures (e.g. approximately +35 °C (+95 °F)) the device or charging cradle may for small periods of time alternately enable and disable battery charging to keep the battery at acceptable temperatures. This process may require additional time to complete a full charge cycle. The cradle indicates when charging is disabled due to abnormal temperatures via the Status LED.

20-Slot Battery Charger

✓ **NOTE:** Ensure that you follow the guidelines for battery safety described in [Battery Safety Guidelines on page 281](#).

The 20-Slot Battery Charger charges up to 20 spare batteries.

Figure 51 20-Slot Battery Charger

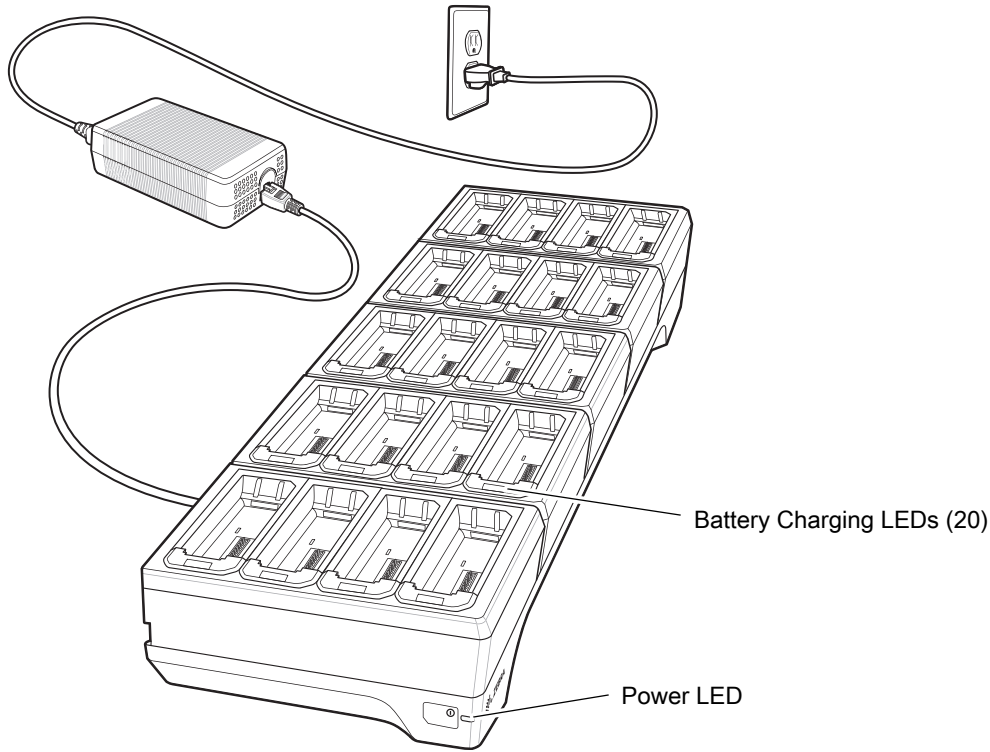
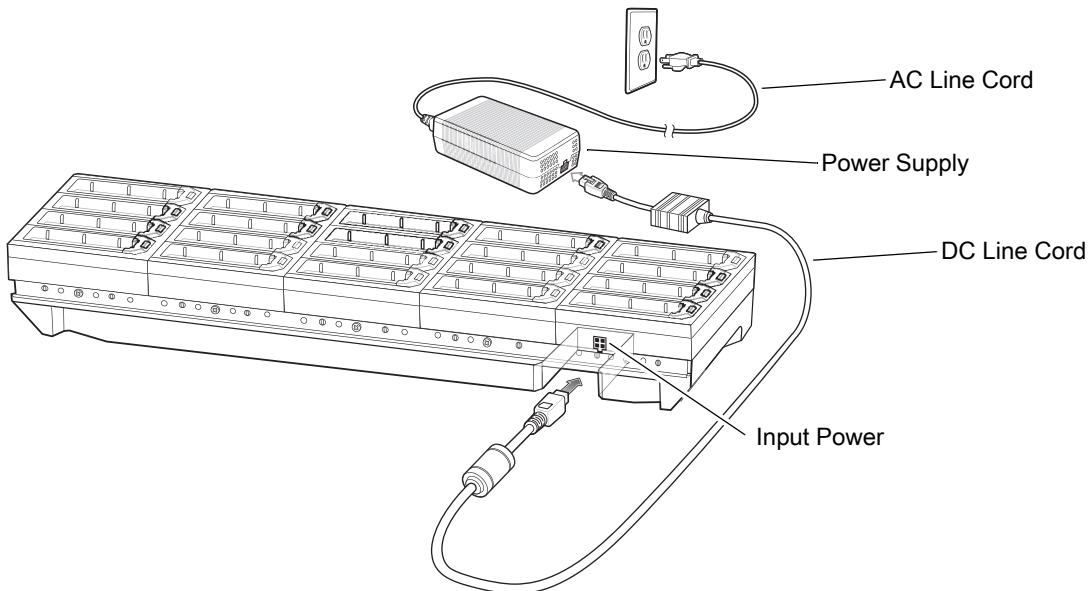

Figure 52 20-Slot Battery Charger



Battery Installation

To install the battery:

1. Insert the battery into a battery slot.
2. Gently press down on the battery until it snaps into place.

Figure 53 Insert Battery into Slot

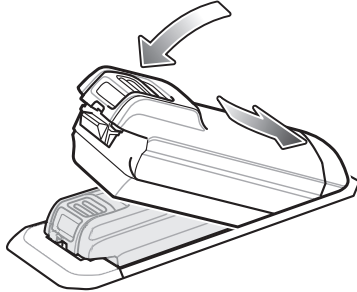

Battery Removal

To remove the battery, press the latch and lift the battery out of the battery slot.

Battery Charging

Spare Battery Charging

Each Battery Charging LED indicates the status of the battery charging in each slot. See [Table 7 on page 86](#). The 3,350 mAh battery fully charges in less than four hours at room temperature.

Charge batteries in temperatures from 0 °C to 40 °C (32 °F to 104 °F). The device and cradle monitor the battery temperature. Battery charging is only performed when the battery is within safe charging temperature limits. At higher temperatures (e.g. approximately +35 °C (+95 °F)) the device or charging cradle may for small periods of time alternately enable and disable battery charging to keep the battery at acceptable temperatures. This process may require additional time to complete a full charge cycle. The cradle indicates when charging is disabled due to abnormal temperatures via the Status LED.

RS6000 Configuration and Update

Introduction

This chapter describes:

- Configuring the RS6000
- Debugging logger
- Upgrading Firmware.

Configuring the RS6000

Introduction

The RS6000 is provided with a default software configuration set in the factory. This software configuration can be optimized by the customer to meet their specific operational requirements. Therefore, before using the RS6000, it is essential to properly configure the RS6000 to harness its extensive capabilities and gain maximum efficiency.

Configure the RS6000 by scanning special configuration bar codes or via the 123Scan² application. When the RS6000 is connected to a Zebra mobile computer, some of the RS6000 configuration parameters can be automatically overwritten by an EMDK application or DataWedge.

DataWedge

DataWedge is an application available on Zebra mobile computers. DataWedge is used to configure scanner settings and process scanned data before sending to an application.

DataWedge is based on profiles. A profile contains information on how DataWedge should behave with different applications. Using profiles, each application can have a specific DataWedge configuration. For example, each user application can have a profile which outputs scanned data in the required format when that application comes to the foreground. DataWedge can be configured to process the same set of captured data differently based on the requirements of each application.

Once connected to a Zebra mobile computer, DataWedge settings override some of the RS6000 parameters previously set via configuration bar codes or 123Scan². These settings only apply while the RS6000 is connected to the Zebra mobile computer, and do not persist once the RS6000 has been disconnected and reset.

For more information on DataWedge, refer to WT6000 Integrator Guide, p/n MN-002699-xx.

123Scan²

123Scan² is a PC-based software tool that enables rapid customized setup of the device.

123Scan² uses a wizard tool to guide users through a streamlined set up process. Settings are saved in a configuration file that can be distributed via e-mail, electronically downloaded via a USB cable, or used to generate a sheet of programming bar codes.

123Scan² can upgrade the device firmware, check on-line to enable support for newly released products, generate a collection of multi-setting bar codes if the number of settings is very large, stage a large number of devices simultaneously, and generate reports with asset tracking information.

For more information on 123Scan², see [123Scan and Software Tools](#).

Real Time Logger

The RS6000 includes a Real Time Logger application that logs events, errors, exceptions and software diagnostics of the RS6000 during its operation. Each log record has a time stamp with a 1 ms resolution. The log record memory size is 4 MB and operates in a cyclic way. Log records reset after cold or clean boot.

Figure 54 shows the Real Time Logger file content as shown on a host computer screen.

Figure 54 Real Time Logger Content Screen

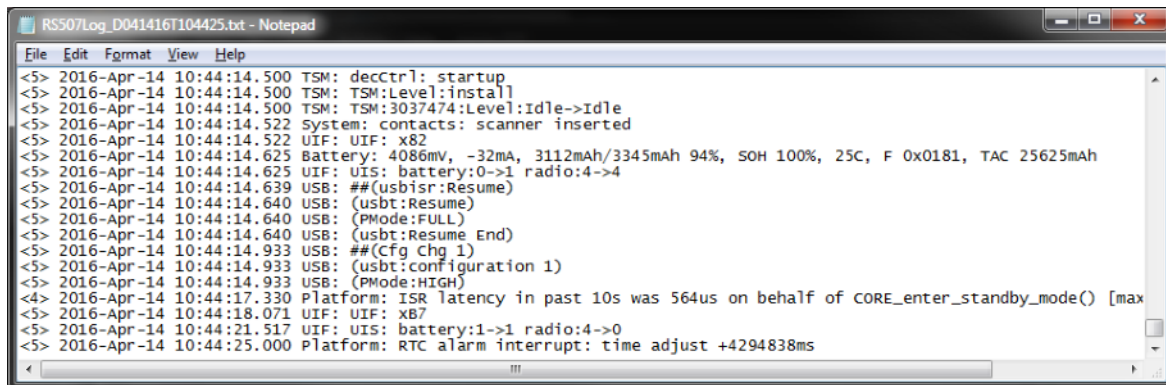

```

RS507Log_D041416T104425.txt - Notepad
File Edit Format View Help
<5> 2016-Apr-14 10:44:14.500 TSM: decCtrl: startup
<5> 2016-Apr-14 10:44:14.500 TSM: TSM:Level:install
<5> 2016-Apr-14 10:44:14.500 TSM: TSM:3037474:Level:Idle->Idle
<5> 2016-Apr-14 10:44:14.522 System: contacts: scanner inserted
<5> 2016-Apr-14 10:44:14.522 UIF: UIF: x82
<5> 2016-Apr-14 10:44:14.625 Battery: 4086mV, -32mA, 3112mAh/3345mAh 94%, SOH 100%, 25C, F 0x0181, TAC 25625mAh
<5> 2016-Apr-14 10:44:14.625 UIF: UIS: battery:0->1 radio:4->4
<5> 2016-Apr-14 10:44:14.639 USB: ##(usbisr:Resume)
<5> 2016-Apr-14 10:44:14.640 USB: (usbtr:Resume)
<5> 2016-Apr-14 10:44:14.640 USB: (PMode:FULL)
<5> 2016-Apr-14 10:44:14.640 USB: (usbtr:Resume End)
<5> 2016-Apr-14 10:44:14.933 USB: ##(Cfg Chg 1)
<5> 2016-Apr-14 10:44:14.933 USB: (usbtr:configuration 1)
<5> 2016-Apr-14 10:44:14.933 USB: (PMode:HIGH)
<4> 2016-Apr-14 10:44:17.330 Platform: ISR latency in past 10s was 564us on behalf of CORE_enter_standby_mode() [max
<5> 2016-Apr-14 10:44:18.071 UIF: UIF: XB7
<5> 2016-Apr-14 10:44:21.517 UIF: UIS: battery:1->1 radio:4->0
<5> 2016-Apr-14 10:44:25.000 Platform: RTC alarm interrupt: time adjust +4294838ms
  
```

Retrieving the RS6000 Log File

The RS6000 log file is retrieved using a host computer, USB cradle and the RS507PCTool application.

The RS507PCTool application requires the Scanner CDC driver be installed on the host computer. This driver creates a virtual COM port (Scanner Virtual COM Port) when the RS6000 is connected to a host computer via USB. Both RS507PCTool and the Scanner USB CDC driver are available for download from zebra.com/support.



SSI over USB CDC (non-persistent)

To obtain log messages over a USB connection:

1. Scan the **SSI over USB CDC** bar code to switch the RS6000 USB connection from SNAPI to CDC / SSI.
2. Connect the RS6000 to the host computer via the 1-slot USB Charging cradle. See [1-Slot RS6000 USB Charging Cradle on page 84](#) for setup.

3. Open the RS507PCTool application.
4. In the **Device** section, click **Open**. The virtual COM port assigned to the RS6000 opens and the **Device Info** for the RS6000 will be shown.

When the RS6000 is connected to the RS507PCTool, the logger time on the RS6000 is synchronized with the host computer's time.

Figure 55 RS507PCTool

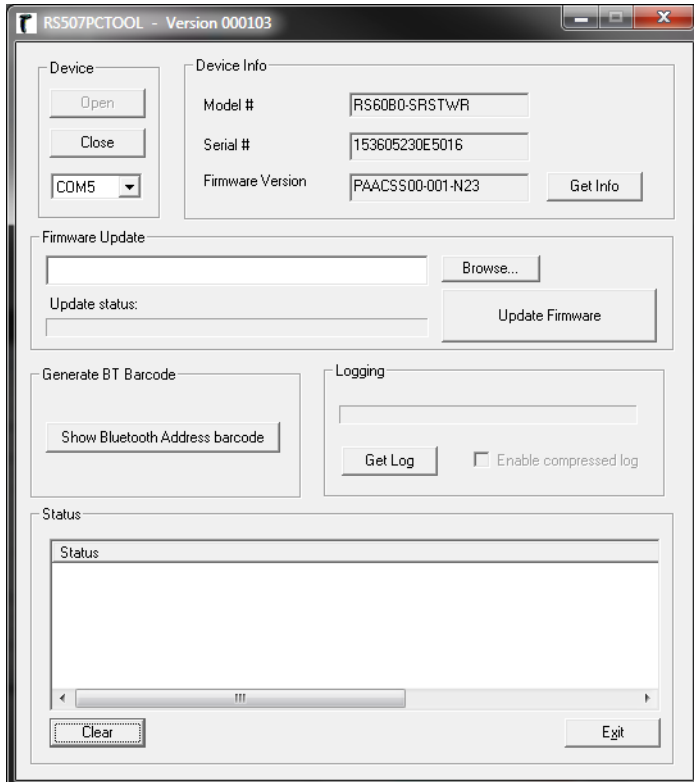

5. Click **Get Log**.
6. The log file is saved in the same directory on the host computer where RS507PCTool application is located.

Figure 56 RS507PCTool Finished Getting Log File

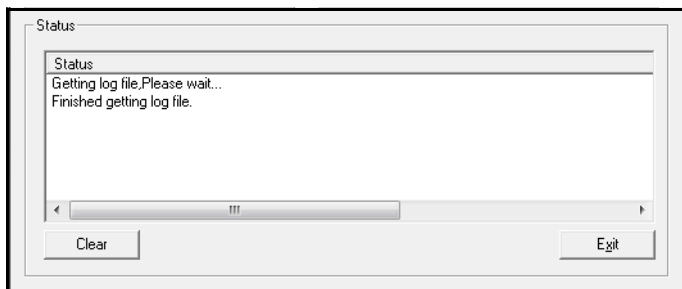

7. The log file name format is RS507Log_D<date&time>.txt

RS6000 Firmware Update

RS6000 devices can be upgraded and re-flashed with a new firmware. The update is performed by downloading the firmware to the RS6000 flash memory. If download fails, the previous firmware remains operational. The

firmware remains inside the RS6000 memory even when powering the RS6000 off/on (removing and re-installing the battery).

Update the RS6000 firmware can be updated by:

- Direct USB using 123Scan²
- Bluetooth connected WT6000.

Direct USB using 123Scan²

The 123Scan² application can upgrade the RS6000 firmware using a USB cable to connect to a host computer. For more information on using 123Scan² see [123Scan and Software Tools](#).

Bluetooth connected WT6000

The Zebra WT6000 wearable computer provides Enterprise Mobility Developer Kit (EMDK) support for updating the firmware of a Bluetooth connected RS6000. Using a Mobile Device Management (MDM) application, RS6000 firmware is deployed to the WT6000 device. Then an EMDK application must be created which downloads the firmware to the RS6000.

Configuring Motion and Proximity

Introduction

This chapter describes the auto-triggering feature of triggerless RS6000 models and provides programming bar codes for configuring this feature.

Motion and proximity detection can be enabled or disabled by the EMDK application, 123Scan² or by scanning configuration bar codes (see [Configuring Motion and Proximity on page 108](#)).

✓ **NOTE:** Once configured, the motion and/or proximity settings are retained in the RS6000 memory following warm or cold boot.

Operation Modes

The RS6000 can be configured to a single or continuous scan operation. In most use cases, a single scan mode is the preferred operation. However, when scanning packages off a moving conveyor belt, it is sometimes recommended to use the continuous scan mode (also referred to as 'Proximity Continuous' mode). Continuous operation automatically results from the combined settings of motion and proximity (enabling or disabling motion and/or proximity. See [Table 8](#)). The RS6000 is provided with motion and proximity enabled by default. To set new values to the motion and/or proximity attributes, refer to [Configuring Motion and Proximity on page 108](#).

Table 8 RS6000 Operation Modes

Mode Number	Parameter States (Motion / Proximity / Continuous Scan)	Description
1	Motion: enabled Proximity: enabled Continuous scan: disabled	The RS6000 performs a single scan when moved and positioned in proximity to an object. Scanning resumes when the RS6000 is moved and re-positioned in proximity to an object. This mode is the default mode.
2	Motion: disabled Proximity: enabled Continuous scan: disabled	The RS6000 performs a single scan when positioned in proximity to an object. The RS6000 stops scanning when the object is out of proximity range.

Table 8 RS6000 Operation Modes

Mode Number	Parameter States (Motion / Proximity / Continuous Scan)	Description
3	Motion: enabled Proximity: disabled Continuous scan: disabled	Upon movement, the RS6000 performs a single scan and stops.
4	Motion: enabled Proximity: enabled Continuous scan: enabled	The RS6000 performs a continuous scan when moved and positioned in proximity to an object. The RS6000 continues to scan as long as it detects an object within its range and bar codes are scanned successfully. The RS6000 stops scanning if proximity to an object is not detected, or if the RS6000 fails to scan three consecutive times.
5	Motion: disabled Proximity: enabled Continuous scan: enabled	The RS6000 starts to continuously scan when positioned in proximity to an object. The RS6000 stops scanning when the object is out of proximity range.

Configuring Motion and Proximity

✓ **NOTE:** Throughout this section, configuration bar codes shown with asterisks (*) indicate default values.

Motion Sensing Control

The Motion Sensing Control Parameter enables/disables the motion trigger feature.



Disable Motion Trigger



*Enable Motion Trigger

Motion Sensitivity

The Motion Sensitivity Parameter selects the sensitivity level of motion detection algorithm.

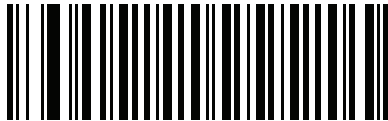

*Normal

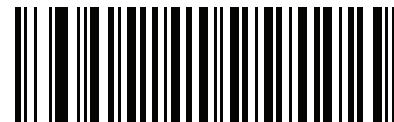

Aggressive



Sensitive

Proximity Sensing Control

The Proximity Sensing Control parameter enables/disables the proximity sensing control feature.



Disable Proximity



***Enable Proximity**

Proximity Continuous Enable

The Proximity Continuous Enable parameter enables/disables the proximity continuous feature.



***Disable Proximity Continues**



Enable Proximity Continues

Proximity Distance

The Proximity Distance parameter sets the proximity sensitivity range.



Short Range



Mid Range



*Long Range

Good Scan Indication Delay Control

The Good Scan Indication Delay parameter sets a delay between good scans when scanning is in continuous mode.

This delay is effective when:

- Motion detection - Enabled
- Proximity - Enabled
- Proximity continues - Enabled

Or

- Motion detection - Disabled
- Proximity - Enabled





Miscellaneous Imager Options

Introduction

You can program the RS6000 to perform various functions, or activate different features. This chapter describes each user preference feature and provides programming bar codes for selecting these features.

The RS6000 ships with the settings shown in [Table 9 on page 114](#) (also see [Standard Default Parameters](#) for all defaults). If the default values suit requirements, programming is not necessary.

To set feature values, scan a single bar code or a short bar code sequence. The settings are stored in non-volatile memory and are preserved even when the RS6000 is powered down.

- ✓ **NOTE:** Most computer monitors allow scanning the bar codes directly on the screen. When scanning from the screen, be sure to set the document magnification to a level where you can see the bar code clearly, and bars and/or spaces are not merging.

To return all features to default values, see [Default Parameters on page 116](#). Throughout the programming bar code menus, asterisks indicate (*) default values.

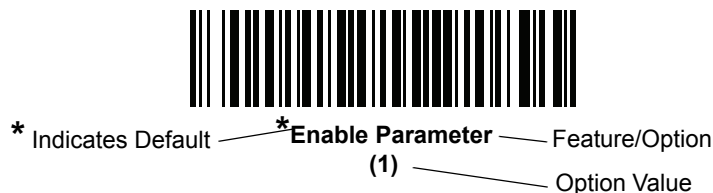

Scanning Sequence Examples

In most cases, scanning one bar code sets the parameter value. For example, to set the beeper tone to high, scan the **High Frequency** (beeper tone) bar code listed under [Beeper Tone on page 120](#). The RS6000 issues a fast warble beep and the LED turns green, signifying a successful parameter entry.

Other parameters, such as **Data Transmission Formats**, require scanning several bar codes. See these parameter descriptions for this procedure.

Errors While Scanning

Unless otherwise specified, to correct an error during a scanning sequence, just re-scan the correct parameter.

User Preferences/Miscellaneous Options Parameter Defaults

[Table 9](#) lists defaults for user preferences parameters. To change the default values:

- Scan the appropriate bar codes in this guide. These new values replace the standard default values in memory. To recall the default parameter values, see [Default Parameters on page 116](#).
- Configure the RS6000 using the 123Scan² configuration program (see [123Scan2 on page 103](#)).

✓ **NOTE:** See [Standard Default Parameters](#) for all user preferences, hosts, symbologies, and miscellaneous default parameters.

Table 9 User Preferences Parameter Defaults

Parameter	Parameter Number ¹	SSI Number ²	Default	Page Number
User Preferences				
Set Default Parameter			Restore Defaults	116
Parameter Bar Code Scanning	236	ECh	Enable	117
Beep After Good Decode	56	38h	Enable	118
Beep on Insertion	288		Enabled	118
Beeper Volume	140	8Ch	High	119
Beeper Tone	145	91h	High	120
Beeper Duration	628	F1h 74h	Medium	121
Suppress Power Up Beeps	721	F1h D1h	Do Not Suppress	121
Low Battery Indication	779	F2h 08h	Enable	122
Hand-Held Trigger Mode	138	8Ah	Level	123

1. Parameter number decimal values are used for programming via RSM commands.

2. SSI number hex values are used for programming via SSI commands.

Table 9 User Preferences Parameter Defaults (Continued)

Parameter	Parameter Number ¹	SSI Number ²	Default	Page Number
Hand-Held Decode Aiming Pattern	306	F0h 32h	Enable	124
Picklist Mode	402	F0h 92h	Disabled Always	125
FIPS Mode	736	F1h E0h	Disable	126
Continuous Bar Code Read	649	F1h 89h	Disable	127
Unique Bar Code Reporting	723	F1h D3h	Enable	127
Decode Session Timeout	136	88h	9.9 Sec	128
Timeout Between Decodes, Same Symbol	137	89h	0.5 Sec	129
Timeout Between Decodes, Different Symbols	144	90h	0.1 sec	130
Fuzzy 1D Processing	514	F1h 02h	Enable	130
Decode Mirror Images (Data Matrix Only)	537	F1h 19h	Auto	131
PDF Prioritization	719	F1h CFh	Disable	133
PDF Prioritization Timeout	720	F1h D0h	200 ms	133
Decoding Illumination	298	F0h 2Ah	Enable	134
Motion Tolerance	858	F2h 5Ah	Less Motion Tolerance	135
Miscellaneous Options				
Add an Enter Key	N/A	N/A	N/A	135
Transmit Code ID Character	45	2Dh	None	135
Prefix Value	99, 105	63h, 69h	7013 <CR><LF>	136
Suffix 1 Value	98, 104	62h, 68h	7013 <CR><LF>	136
Suffix 2 Value	100, 106	64h, 6Ah		
Scan Data Transmission Format	235	EBh	Data as is	137
FN1 Substitution Values	103, 109	67h, 6Dh	7013 <CR><LF>	139
Transmit "No Read" Message	94	5E	Disable	140

1. Parameter number decimal values are used for programming via RSM commands.

2. SSI number hex values are used for programming via SSI commands.

User Preferences

Default Parameters

The RS6000 can be reset to two types of defaults: factory defaults or custom defaults. Scan the appropriate bar code below to reset the RS6000 to its default settings and/or set the RS6000 current settings as the custom default.

- **Restore Defaults** - Resets all default parameters as follows:
 - If custom default values were configured (see **Write to Custom Defaults**), the custom default values are set for all parameters each time the **Restore Defaults** bar code below is scanned.
 - If no custom default values were configured, the factory default values are set for all parameters each time the **Restore Defaults** bar code below is scanned. (For factory default values, see [Standard Default Parameters.](#))
- **Set Factory Defaults** - Scan the **Set Factory Defaults** bar code below to eliminate all custom default values and set the RS6000 to factory default values (For factory default values, see [Standard Default Parameters](#)).
- **Write to Custom Defaults** - Custom default parameters can be configured to set unique default values for all parameters. After changing all parameters to the desired default values, scan the **Write to Custom Defaults** bar code below to configure custom defaults.



***Restore Defaults**



Set Factory Defaults



Write to Custom Defaults

Parameter Bar Code Scanning

Parameter # 236 (SSI # ECh)

To disable the decoding of parameter bar codes, including the **Set Defaults** parameter bar codes, scan the **Disable Parameter Scanning** bar code below. To enable decoding of parameter bar codes, scan **Enable Parameter Scanning**.



***Enable Parameter Bar Code Scanning
(1)**



**Disable Parameter Bar Code Scanning
(0)**

Beep After Good Decode

Parameter # 56 (SSI # 38h)

Scan a bar code below to select whether or not the RS6000 beeps after a good decode. If selecting **Do Not Beep After Good Decode**, the beeper still operates during parameter menu scanning and to indicate error conditions.



***Beep After Good Decode (Enable)**
(1)



Do Not Beep After Good Decode (Disable)
(0)

Beep on Insertion

Parameter # 288

When the RS6000 is inserted into a cradle and detects power, it emits a short low beep. This feature is enabled by default.

To enable or disable beeping on insertion, scan the appropriate bar code below.



***Enable Beep on Insertion**
(00h)



Disable Beep on Insertion
(01h)

Beeper Volume

Parameter # 140 (SSI # 8Ch)

To select a beeper volume, scan the **Low Volume**, **Medium Volume**, or **High Volume** bar code.



Low Volume
(2)



Medium Volume
(1)



***High Volume**
(0)

Beeper Tone

Parameter # 145 (SSI # 91h)

To select a beeper tone, scan one of the following bar codes.

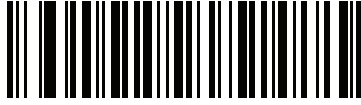

Off
(3)



Low Tone
(2)

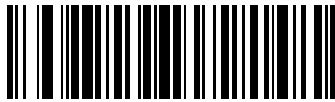

Medium Tone
(1)

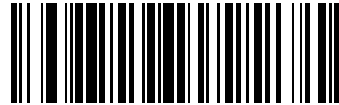

* High Tone
(0)

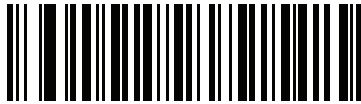

Medium to High Tone (2-tone)
(4)

Beeper Duration

Parameter # 628 (SSI # F1h 74h)

To select the duration for the beeper, scan one of the following bar codes.



**Short
(0)**

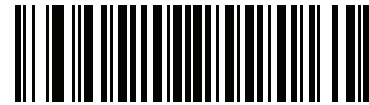

*** Medium
(1)**



**Long
(2)**

Suppress Power Up Beeps

Parameter # 721 (SSI # F1h D1h)

Scan a bar code below to select whether or not to suppress the RS6000 power-up beeps.

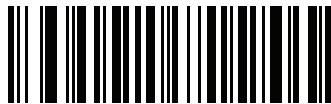

***Do Not Suppress Power Up Beeps
(0)**



**Suppress Power Up Beeps
(1)**

Low Battery Indication

Parameter # 779 (SSI # F2h 0Bh)

Scan a barcode below to select whether or not to suppress the RS6000's low battery indication.



Disable
(0)



***Enable**
(1)

Hand-Held Trigger Mode

Parameter # 138 (SSI # 8Ah)

Select one of the following trigger modes for the RS6000.

- **Standard (Level)** - A trigger pull activates decode processing. Decode processing continues until the bar code decodes, you release the trigger, or the [Decode Session Timeout on page 128](#) occurs.
- **Two Stage:**
 - **Option 1** - This trigger mode presents the laser aiming guide when you press and hold the trigger. Releasing the trigger activates decode processing.
 - **Option 2** - This trigger mode projects the laser aiming guide on the first trigger press. A second trigger press within a short period of time activates decode processing.



NOTE: Hand-held Trigger Mode is not supported for triggerless models and should be left at its default value.

When configured for Bluetooth SSI mode, the triggering mode is controlled by the Zebra Mobile Computer and this setting should be left at its default value.

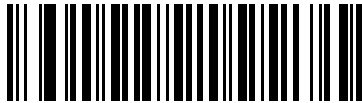

*Level (Standard)
(0)



Two Stage - Option 1
(14)



Two Stage - Option 2
(15)

Hand-Held Decode Aiming Pattern

Parameter # 306 (SSI # F0h 32h)

Select **Enable Hand-Held Decode Aiming Pattern** to project the aiming dot during bar code capture, **Disable Hand-Held Decode Aiming Pattern** to turn the aiming dot off, or **Enable Hand-Held Decode Aiming Pattern on PDF** to project the aiming dot when the RS6000 detects a 2D bar code.

- ✓ **NOTE:** With [Picklist Mode on page 125](#) enabled, the decode aiming dot flashes even when the **Hand-Held Decode Aiming Pattern** is disabled.

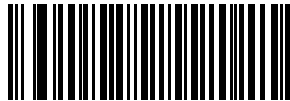

***Enable Hand-Held Decode Aiming Pattern
(2)**

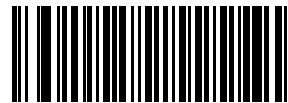

**Disable Hand-Held Decode Aiming Pattern
(0)**

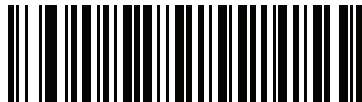

**Enable Hand-Held Decode Aiming Pattern on PDF
(3)**

Picklist Mode

Parameter # 402 (SSI # F0h 92h)

Picklist mode enables the RS6000 to decode only bar codes that are aligned under the LED aiming dot. Select one of the following picklist modes for the RS6000:

- **Disabled Always** - Picklist mode is always disabled.
- **Enabled in Hand-Held Mode** - Picklist mode is enabled in hand-held mode.



***Disabled Always**
(0)

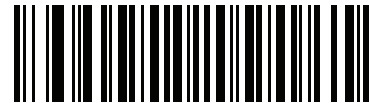

Enabled in Hand-Held Mode
(1)



Enabled Always
(2)



NOTE: Picklist Mode temporarily overrides the Disable Decode Aiming Pattern parameter. You can not disable the decode aiming pattern when Picklist Mode is enabled.

FIPS Mode

Parameter # 736 (F1h E0h)

✓ **NOTE:** FIPS Mode is only supported when paired with the STB3678 cradle.

The Federal Information Processing Standard (FIPS) 140-2 is a U.S. government computer security standard used to accredit cryptographic modules. FIPS enabled DS3678 scanners and cradles offer this secure mode of operation.

To enable the FIPS mode of operation (disabled by default), scan the **Enable FIPS** bar code. The scanner attempts to establish a secure session with the cradle to which it is connected. On success, the scanner lights an amber LED on every trigger pull to signal that all data will be transmitted over Bluetooth in a secure fashion. On failure, the scanner will sound transmission failure error message on every attempt to transmit data.

To disable the FIPS mode, scan the **Disable FIPS** bar code at any time.



Enable FIPS
(1)

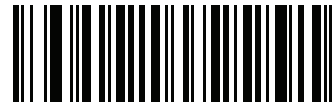

*** Disable FIPS**
(0)

Continuous Bar Code Read

Parameter # 649 (SSI # F1h 89h)

Enable this to report every bar code while the trigger is pulled.

- ✓ **NOTE:** Zebra strongly recommends enabling [Picklist Mode on page 125](#) with this feature. Disabling Picklist Mode can cause accidental decodes when more than one bar code is in the RS6000's field of view.

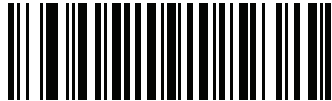

***Disable Continuous Bar Code Read
(0)**

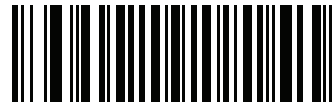

**Enable Continuous Bar Code Read
(1)**

Unique Bar Code Reporting

Parameter # 723 (SSI # F1h D3h)

Enable this to report only unique bar codes while the trigger is pulled. This option only applies when **Continuous Bar Code Read** is enabled.



**Disable Continuous Bar Code Read Uniqueness
(0)**



***Enable Continuous Bar Code Read Uniqueness
(1)**

Decode Session Timeout

Parameter # 136 (SSI # 88h)

This parameter sets the maximum time decode processing continues during a scan attempt. It is programmable in 0.1 second increments from 0.5 to 9.9 seconds. The default timeout is 9.9 seconds.

To set a Decode Session Timeout, scan the bar code below. Next, scan two numeric bar codes from [Alphanumeric and Numeric Bar Codes](#) that correspond to the desired on time. Enter a leading zero for single digit numbers. For example, to set a Decode Session Timeout of 0.5 seconds, scan the bar code below, then scan the **0** and **5** bar codes. To correct an error or change the selection, scan [Cancel on page 329](#).



Decode Session Timeout

Timeout Between Decodes, Same Symbol

Parameter # 137 (SSI # 89h)

Use this option in Continuous Bar Code Read mode to prevent the beeper from continuously beeping when a bar code is left in the RS6000 field of view. The bar code must be out of the field of view for the timeout period before the RS6000 reads the same consecutive bar code. It is programmable in 0.1 second increments from 0.0 to 9.9 seconds. The default interval is 0.5 seconds.

To select the timeout between decodes for the same bar code, scan the bar code below, then scan two numeric bar codes from [Alphanumeric and Numeric Bar Codes](#) that correspond to the desired interval, in 0.1 second increments.



Timeout Between Decodes, Same Symbol

Timeout Between Decodes, Different Symbol

Parameter # 144 (SSI # 90h)

Use this option in presentation mode or Continuous Bar Code Read to control the time the RS6000 is inactive between decoding different bar codes. It is programmable in 0.1 second increments from 0.1 to 9.9 seconds. The default is 0.1 seconds.

To select the timeout between decodes for different bar codes, scan the bar code below, then scan two numeric bar codes from [Alphanumeric and Numeric Bar Codes](#) that correspond to the desired interval, in 0.1 second increments.



NOTE: Timeout Between Decodes, Different Symbols cannot be greater than or equal to the Decode Session Timeout.

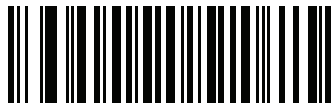

Timeout Between Decodes, Different Symbols

Fuzzy 1D Processing

Parameter # 514 (SSI # F1h 02h)

This option is enabled by default to optimize decode performance on 1D bar codes, including damaged and poor quality bar codes. Disable this only if you experience time delays when decoding 2D bar codes, or in detecting a no decode.



*Enable Fuzzy 1D Processing
(1)



Disable Fuzzy 1D Processing
(0)

Decode Mirror Images (Data Matrix Only)

Parameter # 537 (SSI # F1h 19h)

Select an option for decoding mirror image Data Matrix bar codes:

- Always - decode only Data Matrix bar codes that are mirror images
- Never - do not decode Data Matrix bar codes that are mirror images
- Auto - decode both mirrored and un-mirrored Data Matrix bar codes.



Never
(0)



Always
(1)



***Auto**
(2)

Mobile Phone/Display Mode

Parameter # 716 (SSI # F1h CCh)

This mode improves bar code reading performance off mobile phones and electronic displays. Select Enhanced in hand-held or select Normal Mobile Phone/Display Mode.



***Normal Mobile Phone/Display Mode
(0)**

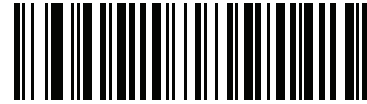

**Enhanced in Hand-Held Mode
(1)**

PDF Prioritization

Parameter # 719 (SSI # F1h CFh)

Enable this feature to delay decoding a 1D bar code (Code 128) by the value specified in [PDF Prioritization Timeout](#). During that time the RS6000 attempts to decode a PDF417 symbol (e.g., on a US driver's license), and if successful, reports this only. If it does not decode (can not find) a PDF417 symbol, it reports the 1D symbol after the timeout. The 1D symbol must be in the device's field of view for the RS6000 to report it. This parameter does not affect decoding other symbologies..

**NOTE:**

The 1D Code 128 bar code lengths include the following:

- 7 to 10 characters
- 14 to 17 characters
- 27 to 28 characters

In addition, a Code 39 bar code with the following lengths are considered to potentially be part of a US driver's license:

- 8 characters
- 12 characters

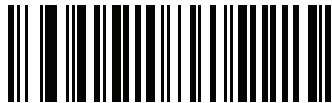

***Disable PDF Prioritization
(0)**



**Enable PDF Prioritization
(1)**

PDF Prioritization Timeout

Parameter # 720 (SSI # F1h D0h)

When [PDF Prioritization](#) is enabled, this timeout specifies how long the RS6000 attempts to decode a PDF417 symbol before reporting the 1D bar code in the field of view.

Scan the following bar code, then scan four digits from [Alphanumeric and Numeric Bar Codes](#) that specify the timeout in milliseconds. For example, to enter 400 ms, scan the following bar code, then scan 0400. The range is 0 to 5000 ms, and the default is 200 ms.



PDF Prioritization Timeout

Decoding Illumination

Parameter # 298 (SSI # F0h 2Ah)

Selecting **Enable Decoding Illumination** causes the RS6000 to flash illumination to aid decoding. Select **Disable Decoding Illumination** to prevent the RS6000 from using decoding illumination.

Enabling illumination usually results in superior bar code reading performance. The effectiveness of the illumination decreases as the distance to the target increases.



*Enable Decoding Illumination
(1)



Disable Decoding Illumination
(0)

Motion Tolerance

Parameter # 858 (SSI # F2h 5Ah)

Less Motion Tolerance provides optimal decoding performance on 1D bar codes.

To increase motion tolerance and speed decoding when scanning a series of 1D bar codes in rapid progression, scan **More Motion Tolerance**.



***Less Motion Tolerance
(0)**

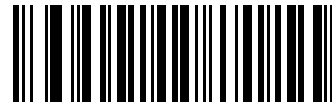

**More Motion Tolerance
(1)**

Miscellaneous Scanner Parameters

Add an Enter Key

To add an Enter key (carriage return/line feed) after scanned data, scan the following bar code.

To program other prefixes and/or suffixes, see [Prefix/Suffix Values on page 136](#).

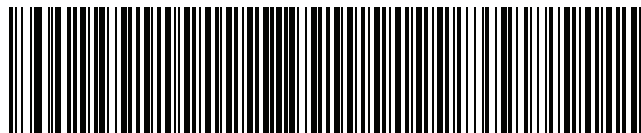

Add Enter Key (Carriage Return/Line Feed)

Transmit Code ID Character

Parameter # 45 (SSI # 2Dh)

A Code ID character identifies the code type of a scanned bar code. This is useful when decoding more than one code type. In addition to any single character prefix already selected, the Code ID character is inserted between the prefix and the decoded symbol.

Select no Code ID character, a Symbol Code ID character, or an AIM Code ID character. For Code ID characters, see [Programming Reference on page 322](#).

- ✓ **NOTE:** If you enable Symbol Code ID Character or AIM Code ID Character, and enable [Transmit “No Read” Message on page 140](#), the RS6000 appends the code ID for Code 39 to the NR message.

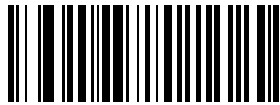

Symbol Code ID Character
(2)

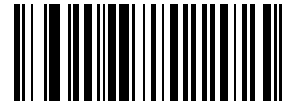

AIM Code ID Character
(1)

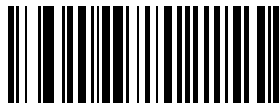

*None
(0)

Prefix/Suffix Values

Key Category Parameter # P = 99, S1 = 98, S2 = 100 (SSI # P = 63h, S1 = 62h, S2 = 64h)

Decimal Value Parameter # P = 105, S1 = 104, S2 = 106 (SSI # P = 69h, S1 = 68h, S2 = 6Ah)

You can append a prefix and/or one or two suffixes to scan data for use in data editing. To set a value for a prefix or suffix, scan a four-digit number (i.e., four bar codes from [Alphanumeric and Numeric Bar Codes](#)) that corresponds to that value. See [ASCII Character Sets](#) for the four-digit codes.

When using host commands to set the prefix or suffix, set the key category parameter to 1, then set the 3-digit decimal value. See [ASCII Character Sets](#) for the four-digit codes.

The default prefix and suffix value is 7013 <CR><LF> (the Enter key). To correct an error or change a selection, scan [Cancel on page 329](#).

- ✓ **NOTE:** To use Prefix/Suffix values, first set the [Scan Data Transmission Format on page 137](#).

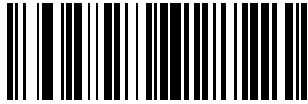

**Scan Prefix
(7)**

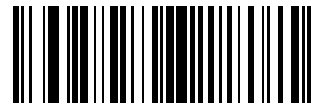

**Scan Suffix 1
(6)**



**Scan Suffix 2
(8)**



Data Format Cancel

Scan Data Transmission Format

Parameter # 235 (SSI # EBh)

To change the scan data format, scan one of the following eight bar codes corresponding to the desired format.

✓ **NOTE:** If using this parameter do not use ADF rules to set the prefix/suffix.

To set values for the prefix and/or suffix, see [Prefix/Suffix Values on page 136](#).



***Data As Is**
(0)



<DATA> <SUFFIX 1>
(1)



<DATA> <SUFFIX 2>
(2)



<DATA> <SUFFIX 1> <SUFFIX 2>
(3)



<PREFIX> <DATA >
(4)

Scan Data Transmission Format (continued)

<PREFIX> <DATA> <SUFFIX 1>
(5)



<PREFIX> <DATA> <SUFFIX 2>
(6)



<PREFIX> <DATA> <SUFFIX 1> <SUFFIX 2>
(7)

FN1 Substitution Values**Key Category Parameter # 103 (SSI # 67h)****Decimal Value Parameter # 109 (SSI # 6Dh)**

The wedge and USB HID keyboard hosts support a FN1 Substitution feature. Enabling this substitutes any FN1 character (0x1b) in an EAN128 bar code with a value. This value defaults to 7013 (Enter Key).

When using host commands to set the FN1 substitution value, set the key category parameter to 1, then set the 3-digit keystroke value. See the ASCII Character Set table for the current host interface for the desired value.

To select a FN1 substitution value via bar code menus:

1. Scan the bar code below.



Set FN1 Substitution Value

2. Locate the keystroke desired for FN1 Substitution in the ASCII Character Set table for the current host interface. Enter the 4-digit ASCII Value by scanning each digit in [Alphanumeric and Numeric Bar Codes](#).

To correct an error or change the selection, scan **Cancel**.

To enable FN1 substitution for USB HID keyboard, scan the **Enable FN1 Substitution** bar code on page 38.

Transmit “No Read” Message

Parameter # 94 (SSI # 5Eh)

Scan a bar code below to select whether or not to transmit a No Read message. Enable this to transmit the characters NR when a successful decode does not occur before trigger release or the **Decode Session Timeout** expires. See [Decode Session Timeout on page 128](#). Disable this to send nothing to the host if a symbol does not decode.

- ✓ **NOTE:** If you enable **Transmit No Read**, and also enable Symbol Code ID Character or AIM Code ID Character for [Transmit Code ID Character on page 135](#), the RS6000 appends the code ID for Code 39 to the NR message.



**Enable No Read
(1)**



***Disable No Read
(0)**

Symbologies

Introduction

This chapter describes symbology features and provides programming bar codes for selecting these features. To set feature values, scan a single bar code or a short bar code sequence. The settings are stored in non-volatile memory and are preserved even when the RS6000 powers down.

✓ **NOTE:** Most computer monitors allow scanning the bar codes directly on the screen. When scanning from the screen, be sure to set the document magnification to a level where you can see the bar code clearly, and bars and/or spaces do not merge.

Select a host type (see each host chapter for specific host information) after the power-up beeps sound. This is only necessary upon the first power-up when connected to a new host.

To return all features to default values, see [Default Parameters on page 116](#). Throughout the programming bar code menus, asterisks (*) indicate default values.

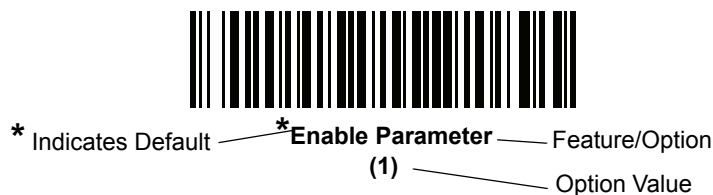

Scanning Sequence Examples

In most cases, scanning one bar code sets the parameter value. For example, to transmit bar code data without the UPC-A check digit, simply scan the **Do Not Transmit UPC-A Check Digit** bar code under [Transmit UPC-A Check Digit on page 157](#). The RS6000 issues a fast warble beep and the LED turns green, signifying a successful parameter entry.

Other parameters, such as **Set Length(s) for D 2 of 5** require scanning several bar codes. See the individual parameter, such as **Set Length(s) for D 2 of 5**, for this procedure.

Errors While Scanning

Unless otherwise specified, to correct an error during a scanning sequence, just re-scan the correct parameter.

Symbology Parameter Defaults

Table 10 lists the defaults for all symbology parameters. To change the default values, scan the appropriate bar codes in this guide. These new values replace the standard default values in memory. To recall the default parameter values, see [Default Parameters on page 116](#).

✓ **NOTE:** See [Standard Default Parameters](#) for all user preferences, hosts, and miscellaneous default parameters.

Table 10 Symbology Parameter Defaults

Parameter	Parameter Number	SSI Number	Default	Page Number
Enable/Disable All Code Types				148
1D Symbologies				
UPC/EAN				
UPC-A	1	01h	Enable	149
UPC-E	2	02h	Enable	149
UPC-E1	12	0Ch	Disable	150
EAN-8/JAN 8	4	04h	Enable	150
EAN-13/JAN 13	3	03h	Enable	151
Bookland EAN	83	53h	Disable	151
Decode UPC/EAN/JAN Supplementals (2 and 5 digits)	16	10h	Ignore	153
User-Programmable Supplementals			000	155
Supplemental 1:	579	F1h 43h		
Supplemental 2:	580	F1h 44h		
UPC/EAN/JAN Supplemental Redundancy	80	50h	10	155
Decode UPC/EAN/JAN Supplemental AIM ID	672	F1h A0h	Combined	156
UPC Reduced Quiet Zone	1289	F8h 05h 09h	Disable	157
Transmit UPC-A Check Digit	40	28h	Enable	157
Transmit UPC-E Check Digit	41	29h	Enable	158
Transmit UPC-E1 Check Digit	42	2Ah	Enable	158
UPC-A Preamble	34	22h	System Character	159
UPC-E Preamble	35	23h	System Character	160
UPC-E1 Preamble	36	24h	System Character	161
Convert UPC-E to A	37	25h	Disable	162

Table 10 Symbology Parameter Defaults (Continued)

Parameter	Parameter Number	SSI Number	Default	Page Number
Convert UPC-E1 to A	38	26h	Disable	162
EAN-8/JAN-8 Extend	39	27h	Disable	163
Bookland ISBN Format	576	F1h 40h	ISBN-10	164
UCC Coupon Extended Code	85	55h	Disable	165
Coupon Report	730	F1h DAh	New Coupon Format	166
ISSN EAN	617	F1h 69h	Disable	167
Code 128				
Code 128	8	08h	Enable	168
Set Length(s) for Code 128	209, 210	D1h, D2h	1 to 55	169
GS1-128 (formerly UCC/EAN-128)	14	0Eh	Enable	171
ISBT 128	84	54h	Enable	171
ISBT Concatenation	577	F1h 41h	Autodiscriminate	172
Check ISBT Table	578	F1h 42h	Enable	173
ISBT Concatenation Redundancy	223	DFh	10	173
Code 128 Security Level	751	F1h EFh	Security Level 1	174
Code 128 Reduced Quiet Zone	1208	F8h 04h B8h	Disable	175
Ignore Code 128 <FNC4>	1254	F8h 04h E6h	Disable	175
Code 128 Exclusive	Param 673	SSI F1h A1H	Disable	176
Code 39				
Code 39	0	00h	Enable	177
Trioptic Code 39	13	0Dh	Disable	177
Convert Code 39 to Code 32 (Italian Pharmacy Code)	86	56h	Disable	178
Code 32 Prefix	231	E7h	Disable	179
Set Length(s) for Code 39	18, 19	12h, 13h	1 to 55	180
Code 39 Check Digit Verification	48	30h	Disable	181
Transmit Code 39 Check Digit	43	2Bh	Disable	181
Code 39 Full ASCII Conversion	17	11h	Disable	182
Code 39 Security Level	750	F1h EEh	Security Level 1	183
Code 39 Reduced Quiet Zone	1209	F8h 04h B9h	Disable	184
Code 39 Buffering - Scan and Store	113	71h	Disable	184

Table 10 Symbology Parameter Defaults (Continued)

Parameter	Parameter Number	SSI Number	Default	Page Number
Code 93				
Code 93	9	09h	Enable	187
Set Length(s) for Code 93	26, 27	1Ah, 1Bh	1 to 55	187
Code 11				
Code 11	10	0Ah	Disable	189
Set Lengths for Code 11	28, 29	1Ch, 1Dh	4 to 55	189
Code 11 Check Digit Verification	52	34h	Disable	191
Transmit Code 11 Check Digit(s)	47	2Fh	Disable	192
Interleaved 2 of 5 (ITF)				
Interleaved 2 of 5 (ITF)	6	06h	Disable	193
Set Lengths for I 2 of 5	22, 23	16h, 17h	6 to 55	194
I 2 of 5 Check Digit Verification	49	31h	Disable	196
Transmit I 2 of 5 Check Digit	44	2Ch	Disable	197
Convert I 2 of 5 to EAN 13	82	52h	Disable	197
I 2 of 5 Security Level	1121	F8h 04h 61h	Security Level 1	198
I 2 of 5 Reduced Quiet Zone	1210	F8h 04h BAh	Disable	199
Discrete 2 of 5 (DTF)				
Discrete 2 of 5	5	05h	Disable	200
Set Length(s) for D 2 of 5	20, 21	14h 15h	1 to 55	201
Codabar (NW - 7)				
Codabar	7	07h	Enable	203
Set Lengths for Codabar	24, 25	18h, 19h	4 to 55	203
CLSI Editing	54	36h	Disable	205
NOTIS Editing	55	37h	Disable	205
Codabar Upper or Lower Case Start/ Stop Characters Detection	855	F2h 57h	Upper Case	206
MSI				
MSI	11	0Bh	Disable	207
Set Length(s) for MSI	30, 31	1Eh, 1Fh	4 to 55	207
MSI Check Digits	50	32h	One	209
Transmit MSI Check Digit	46	2Eh	Disable	209

Table 10 Symbology Parameter Defaults (Continued)

Parameter	Parameter Number	SSI Number	Default	Page Number
MSI Check Digit Algorithm	51	33h	Mod 10/Mod 10	210
Chinese 2 of 5				
Chinese 2 of 5	408	F0h 98h	Disable	211
Matrix 2 of 5				
Matrix 2 of 5	618	F1h 6Ah	Disable	212
Matrix 2 of 5 Lengths	619 620	F1h 6Bh F1h 6Ch	4 to 55	212
Matrix 2 of 5 Check Digit	622	F1h 6Eh	Disable	214
Transmit Matrix 2 of 5 Check Digit	623	F1h 6Fh	Disable	214
Korean 3 of 5				
Korean 3 of 5	581	F1h 45h	Disable	215
Inverse 1D	586	F1h 4Ah	Regular	216
GS1 DataBar				
GS1 DataBar-14	338	F0h 52h	Enable	217
GS1 DataBar Limited	339	F0h 53h	Enable	217
GS1 DataBar Expanded	340	F0h 54h	Enable	218
Convert GS1 DataBar to UPC/EAN	397	F0h 8Dh	Disable	218
GS1 DataBar Limited Security Level	728	F1h D8h	Level 3	219
Composite				
Composite CC-C	341	F0h 55h	Disable	220
Composite CC-A/B	342	F0h 56h	Disable	220
Composite TLC-39	371	F0h 73h	Disable	221
UPC Composite Mode	344	F0h 58h	UPC Never Linked	222
Composite Beep Mode	398	F0h 8Eh	Beep As Each Code Type is Decoded	223
GS1-128 Emulation Mode for UCC/EAN Composite Codes	427	F0h ABh	Disable	223
2D Symbologies				
PDF417	15	0Fh	Enable	224
MicroPDF417	227	E3h	Disable	224
Code 128 Emulation	123	7Bh	Disable	225
Data Matrix	292	F0h 24h	Enable	226

Table 10 Symbology Parameter Defaults (Continued)

Parameter	Parameter Number	SSI Number	Default	Page Number
GS1 Data Matrix	1336	F8h 05h 38h	Disable	226
Data Matrix Inverse	588	F1h 4Ch	Inverse Autodetect	227
Maxicode	294	F0h 26h	Disable	227
QR Code	293	F0h 25h	Enable	228
GS1 QR	1343	F8h 05h 3Fh	Disable	228
MicroQR	573	F1h 3Dh	Enable	229
Inverse QR	587	SSI F1h 4Bh	Regular	229
Aztec	574	F1h 3Eh	Enable	230
Aztec Inverse	589	F1h 4Dh	Inverse Autodetect	230
Han Xin	1167	F8h 04h 8Fh	Disable	231
Han Xin Inverse	1168	F8h 04h 90h	Regular	231
Postal Codes				
US Postnet	89	59h	Disable	232
US Planet	90	5Ah	Disable	232
Transmit US Postal Check Digit	95	5Fh	Enable	233
UK Postal	91	5Bh	Disable	233
Transmit UK Postal Check Digit	96	60h	Enable	234
Japan Postal	290	F0h 22h	Disable	234
Australia Post	291	F0h 23h	Disable	235
Australia Post Format	718	F1h CEh	Autodiscriminate	236
Netherlands KIX Code	326	F0h 46h	Disable	237
USPS 4CB/One Code/Intelligent Mail	592	F1h 50h	Disable	237
UPU FICS Postal	611	F1h 63h	Disable	238
Mailmark	1337	F8h 05h 39h	Disable	238
Canada Post	92	5Ch	Disable	239
Symbology-Specific Security Levels				
Redundancy Level	78	4Eh	1	240
Security Level	77	4Dh	1	242
1D Quiet Zone Level	1288	F8h 05h 08h	1	243
Intercharacter Gap Size	381	F0h 7Dh	Normal	244
Report Version				244

Table 10 Symbology Parameter Defaults (Continued)

Parameter	Parameter Number	SSI Number	Default	Page Number
Macro PDF				
Flush Macro PDF Buffer	N/A	N/A	N/A	245
Abort Macro PDF Entry	N/A	N/A	N/A	245

Enable/Disable All Code Types

To disable all symbologies, scan **Disable All Code Types** below. This is useful when enabling only a few code types.

Scan **Enable All Code Types** turn on (enable) all code types. This is useful when you want to read all codes, or when you want to disable only a few code types.



Disable All Code Types



Enable All Code Types

UPC/EAN

Enable/Disable UPC-A

Parameter # 1 (SSI # 01h)

To enable or disable UPC-A, scan the appropriate bar code below.

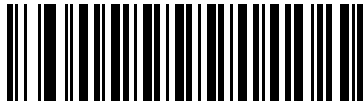

***Enable UPC-A
(1)**

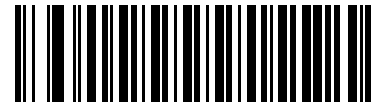

**Disable UPC-A
(0)**

Enable/Disable UPC-E

Parameter # 2 (SSI # 02h)

To enable or disable UPC-E, scan the appropriate bar code below.

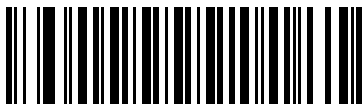

***Enable UPC-E
(1)**



**Disable UPC-E
(0)**

Enable/Disable UPC-E1

Parameter # 12 (SSI # 0Ch)

UPC-E1 is disabled by default.

To enable or disable UPC-E1, scan the appropriate bar code below.

✓ **NOTE:** UPC-E1 is not a UCC (Uniform Code Council) approved symbology.

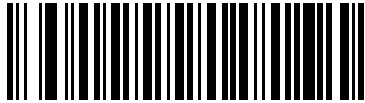

**Enable UPC-E1
(1)**

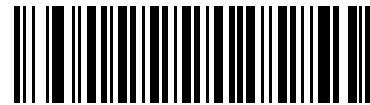

***Disable UPC-E1
(0)**

Enable/Disable EAN-8/JAN-8

Parameter # 4 (SSI # 04h)

To enable or disable EAN-8/JAN-8, scan the appropriate bar code below.



***Enable EAN-8/JAN-8
(1)**



**Disable EAN-8/JAN-8
(0)**

Enable/Disable EAN-13/JAN-13

Parameter # 3 (SSI # 03h)

To enable or disable EAN-13/JAN-13, scan the appropriate bar code below.

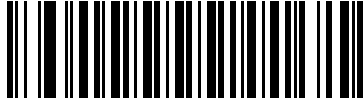

***Enable EAN-13/JAN-13
(1)**

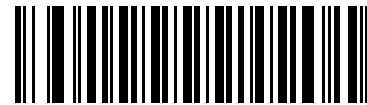

**Disable EAN-13/JAN-13
(0)**

Enable/Disable Bookland EAN

Parameter # 83 (SSI # 53h)

To enable or disable Bookland EAN, scan the appropriate bar code below.

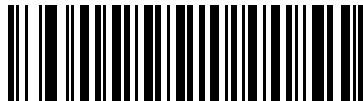

**Enable Bookland EAN
(1)**

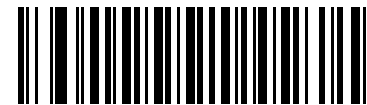

***Disable Bookland EAN
(0)**



NOTE: If you enable Bookland EAN, select a [Bookland ISBN Format on page 164](#). Also select either Decode UPC/EAN Supplementals, Autodiscriminate UPC/EAN Supplementals, or Enable 978/979 Supplemental Mode in [Decode UPC/EAN/JAN Supplementals on page 152](#).

Decode UPC/EAN/JAN Supplementals

Parameter # 16 (SSI # 10h)

Supplementals are bar codes appended according to specific format conventions (e.g., UPC A+2, UPC E+2, EAN 13+2). The following options are available:

- If you select **Ignore UPC/EAN with Supplementals**, and the RS6000 is presented with a UPC/EAN plus supplemental symbol, the RS6000 decodes UPC/EAN and ignores the supplemental characters.
- If you select **Decode UPC/EAN with Supplementals**, the RS6000 only decodes UPC/EAN symbols with supplemental characters, and ignores symbols without supplementals.
- If you select **Autodiscriminate UPC/EAN Supplementals**, the RS6000 decodes UPC/EAN symbols with supplemental characters immediately. If the symbol does not have a supplemental, the RS6000 must decode the bar code the number of times set via [UPC/EAN/JAN Supplemental Redundancy on page 155](#) before transmitting its data to confirm that there is no supplemental.
- If you select one of the following **Supplemental Mode** options, the RS6000 immediately transmits EAN-13 bar codes starting with that prefix that have supplemental characters. If the symbol does not have a supplemental, the RS6000 must decode the bar code the number of times set via [UPC/EAN/JAN Supplemental Redundancy on page 155](#) before transmitting its data to confirm that there is no supplemental. The RS6000 transmits UPC/EAN bar codes that do not have that prefix immediately.
 - Enable 378/379 Supplemental Mode
 - Enable 978/979 Supplemental Mode



NOTE: If you select 978/979 Supplemental Mode and are scanning Bookland EAN bar codes, see [Enable/Disable Bookland EAN on page 151](#) to enable Bookland EAN, and select a format using [Bookland ISBN Format on page 164](#).

- Enable 977 Supplemental Mode
- Enable 414/419/434/439 Supplemental Mode
- Enable 491 Supplemental Mode
- **Enable Smart Supplemental Mode** - applies to EAN-13 bar codes starting with any prefix listed previously.
- **Supplemental User-Programmable Type 1** - applies to EAN-13 bar codes starting with a 3-digit user-defined prefix. Set this 3-digit prefix using [User-Programmable Supplementals on page 155](#).
- **Supplemental User-Programmable Type 1 and 2** - applies to EAN-13 bar codes starting with either of two 3-digit user-defined prefixes. Set the 3-digit prefixes using [User-Programmable Supplementals on page 155](#).
- **Smart Supplemental Plus User-Programmable 1** - applies to EAN-13 bar codes starting with any prefix listed previously or the user-defined prefix set using [User-Programmable Supplementals on page 155](#).
- **Smart Supplemental Plus User-Programmable 1 and 2** - applies to EAN-13 bar codes starting with any prefix listed previously or one of the two user-defined prefixes set using [User-Programmable Supplementals on page 155](#)



NOTE: To minimize the risk of invalid data transmission, select either to decode or ignore supplemental characters.

Decode UPC/EAN/JAN Supplementals (continued)



**Decode UPC/EAN/JAN Only With Supplementals
(1)**

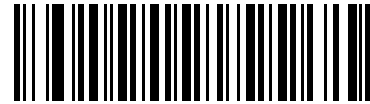

***Ignore Supplementals
(0)**

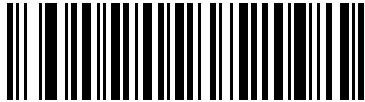

**Autodiscriminate UPC/EAN/JAN Supplementals
(2)**

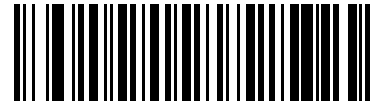

**Enable 378/379 Supplemental Mode
(4)**



**Enable 978/979 Supplemental Mode
(5)**



**Enable 977 Supplemental Mode
(7)**

Decode UPC/EAN/JAN Supplementals (continued)



Enable 414/419/434/439 Supplemental Mode
(6)



Enable 491 Supplemental Mode
(8)



Enable Smart Supplemental Mode
(3)



Supplemental User-Programmable Type 1
(9)



Supplemental User-Programmable Type 1 and 2
(10)



Smart Supplemental Plus User-Programmable 1
(11)



Smart Supplemental Plus User-Programmable 1
and 2
(12)

User-Programmable Supplementals

Supplemental 1: Parameter # 579 (SSI # F1h 43h)

Supplemental 2: Parameter # 580 (SSI # F1h 44h)

If you selected a Supplemental User-Programmable option from [Decode UPC/EAN/JAN Supplementals on page 152](#), select **User-Programmable Supplemental 1** to set the 3-digit prefix. Then select the 3 digits using the numeric bar codes beginning on page [328](#). Select **User-Programmable Supplemental 2** to set a second 3-digit prefix. Then select the 3 digits using the numeric bar codes beginning on page [328](#). The default is 000 (zeroes).



User-Programmable Supplemental 1



User-Programmable Supplemental 2

UPC/EAN/JAN Supplemental Redundancy

Parameter # 80 (SSI # 50h)

If you selected **Autodiscriminate UPC/EAN/JAN Supplementals**, this option adjusts the number of times to decode a symbol without supplementals before transmission. The range is from two to thirty times. Five or above is recommended when decoding a mix of UPC/EAN/JAN symbols with and without supplementals. The default is 10.

Scan the bar code below to set a decode redundancy value. Next, scan two numeric bar codes in [Alphanumeric and Numeric Bar Codes](#). Enter a leading zero for single digit numbers. To correct an error or change a selection, scan [Cancel on page 329](#).

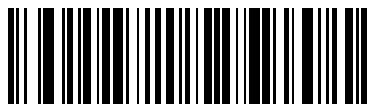

UPC/EAN/JAN Supplemental Redundancy

UPC/EAN/JAN Supplemental AIM ID Format

Parameter # 672 (SSI # F1h A0h)

Select an output format when reporting UPC/EAN/JAN bar codes with Supplementals with [Transmit Code ID Character](#) on page 135 set to **AIM Code ID Character**:

- **Separate** - transmit UPC/EAN with supplementals with separate AIM IDs but one transmission, i.e.:
]E<0 or 4><data>]E<1 or 2>[supplemental data]
- **Combined** – transmit UPC/EAN with supplementals with one AIM ID and one transmission, i.e.:
]E3<data+supplemental data>
- **Separate Transmissions** - transmit UPC/EAN with supplementals with separate AIM IDs and separate transmissions, i.e.:

]E<0 or 4><data>
]E<1 or 2>[supplemental data]



Separate
(0)



*Combined
(1)



Separate Transmissions
(2)

UPC Reduced Quiet Zone

Parameter # 1289 (SSI # F8h 05h 09h)

Scan one of the following bar codes to enable or disable decoding UPC bar codes with reduced quiet zones. If you select **Enable**, select a [1D Quiet Zone Level on page 243](#).

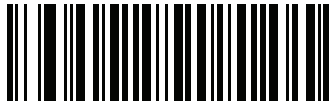

**Enable UPC Reduced Quiet Zone
(1)**

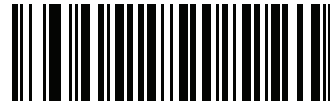

***Disable UPC Reduced Quiet Zone
(0)**

Transmit UPC-A Check Digit

Parameter # 40 (SSI # 28h)

The check digit is the last character of the symbol used to verify the integrity of the data. Scan the appropriate bar code below to transmit the bar code data with or without the UPC-A check digit. It is always verified to guarantee the integrity of the data.



***Transmit UPC-A Check Digit
(1)**

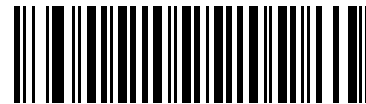

**Do Not Transmit UPC-A Check Digit
(0)**

Transmit UPC-E Check Digit

Parameter # 41 (SSI # 29h)

The check digit is the last character of the symbol used to verify the integrity of the data. Scan the appropriate bar code below to transmit the bar code data with or without the UPC-E check digit. It is always verified to guarantee the integrity of the data.

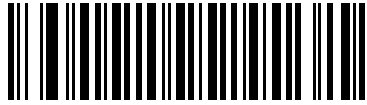

***Transmit UPC-E Check Digit
(1)**

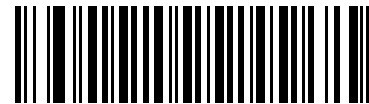

**Do Not Transmit UPC-E Check Digit
(0)**

Transmit UPC-E1 Check Digit

Parameter # 42 (SSI # 2Ah)

The check digit is the last character of the symbol used to verify the integrity of the data. Scan the appropriate bar code below to transmit the bar code data with or without the UPC-E1 check digit. It is always verified to guarantee the integrity of the data.

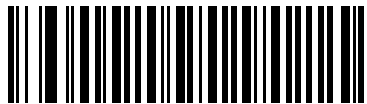

***Transmit UPC-E1 Check Digit
(1)**



**Do Not Transmit UPC-E1 Check Digit
(0)**

UPC-A Preamble

Parameter # 34 (SSI # 22h)

Preamble characters are part of the UPC symbol, and include Country Code and System Character. There are three options for transmitting a UPC-A preamble to the host device: transmit System Character only, transmit System Character and Country Code ("0" for USA), and transmit no preamble. Select the appropriate option to match the host system.

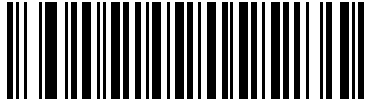

No Preamble (<DATA>
(0)

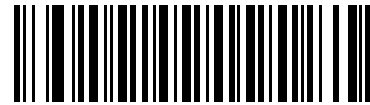

*System Character (<SYSTEM CHARACTER>
<DATA>
(1)

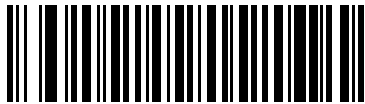

System Character & Country Code
(< COUNTRY CODE> <SYSTEM CHARACTER>
<DATA>
(2)

UPC-E Preamble

Parameter # 35 (SSI # 23h)

Preamble characters are part of the UPC symbol, and include Country Code and System Character. There are three options for transmitting a UPC-E preamble to the host device: transmit System Character only, transmit System Character and Country Code ("0" for USA), and transmit no preamble. Select the appropriate option to match the host system.



No Preamble (<DATA>
(0)

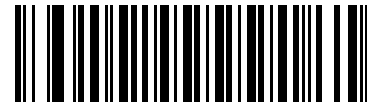

*System Character (<SYSTEM CHARACTER>
<DATA>
(1)

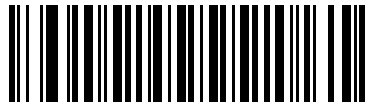

System Character & Country Code
(< COUNTRY CODE> <SYSTEM CHARACTER>
<DATA>
(2)

UPC-E1 Preamble

Parameter # 36 (SSI # 24h)

Preamble characters are part of the UPC symbol, and include Country Code and System Character. There are three options for transmitting a UPC-E1 preamble to the host device: transmit System Character only, transmit System Character and Country Code ("0" for USA), and transmit no preamble. Select the appropriate option to match the host system.

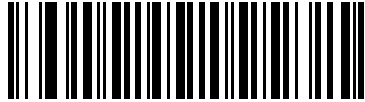

No Preamble (<DATA>)
(0)



*System Character (<SYSTEM CHARACTER> <DATA>)
(1)

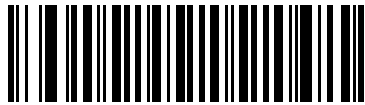

System Character & Country Code
(< COUNTRY CODE> <SYSTEM CHARACTER> <DATA>)
(2)

Convert UPC-E to UPC-A

Parameter # 37 (SSI # 25h)

Enable this to convert UPC-E (zero suppressed) decoded data to UPC-A format before transmission. After conversion, the data follows UPC-A format and is affected by UPC-A programming selections (e.g., Preamble, Check Digit).

Disable this to transmit UPC-E decoded data as UPC-E data, without conversion.



Convert UPC-E to UPC-A (Enable)
(1)

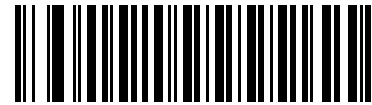

*Do Not Convert UPC-E to UPC-A (Disable)
(0)

Convert UPC-E1 to UPC-A

Parameter # 38 (SSI # 26h)

Enable this to convert UPC-E1 decoded data to UPC-A format before transmission. After conversion, the data follows UPC-A format and is affected by UPC-A programming selections (e.g., Preamble, Check Digit).

Disable this to transmit UPC-E1 decoded data as UPC-E1 data, without conversion.

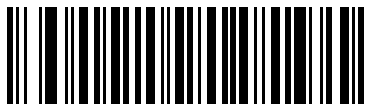

Convert UPC-E1 to UPC-A (Enable)
(1)

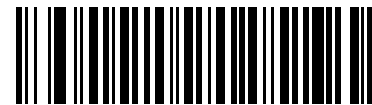

*Do Not Convert UPC-E1 to UPC-A (Disable)
(0)

EAN-8/JAN-8 Extend

Parameter # 39 (SSI # 27h)

Enable this parameter to add five leading zeros to decoded EAN-8 symbols to make them compatible in format to EAN-13 symbols. Disable this to transmit EAN-8 symbols as is.



**Enable EAN/JAN Zero Extend
(1)**

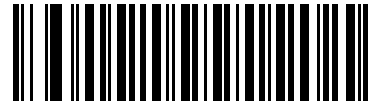

***Disable EAN/JAN Zero Extend
(0)**

Bookland ISBN Format

Parameter # 576 (SSI # F1h 40h)

If you enabled Bookland EAN using [Enable/Disable Bookland EAN on page 151](#), select one of the following formats for Bookland data:

- **Bookland ISBN-10** - The RS6000 reports Bookland data starting with 978 in traditional 10-digit format with the special Bookland check digit for backward-compatibility. Data starting with 979 is not considered Bookland in this mode.
- **Bookland ISBN-13** - The RS6000 reports Bookland data (starting with either 978 or 979) as EAN-13 in 13-digit format to meet the 2007 ISBN-13 protocol.



***Bookland ISBN-10
(0)**



**Bookland ISBN-13
(1)**



NOTE: For Bookland EAN to function properly, first enable Bookland EAN using [Enable/Disable Bookland EAN on page 151](#), then select either Decode UPC/EAN Supplementals, Autodiscriminate UPC/EAN Supplementals, or Enable 978/979 Supplemental Mode in [Decode UPC/EAN/JAN Supplementals on page 152](#).

UCC Coupon Extended Code

Parameter # 85 (SSI # 55h)

Enable this parameter to decode UPC-A bar codes starting with digit '5', EAN-13 bar codes starting with digit '99', and UPC-A/GS1-128 Coupon Codes. UPCA, EAN-13, and GS1-128 must be enabled to scan all types of Coupon Codes.

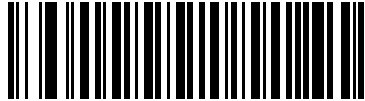

**Enable UCC Coupon Extended Code
(1)**

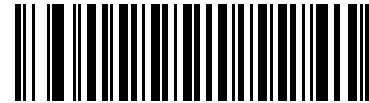

***Disable UCC Coupon Extended Code
(0)**



NOTE: See [UPC/EAN/JAN Supplemental Redundancy on page 155](#) to control autodiscrimination of the GS1-128 (right half) of a coupon code.

Coupon Report

Parameter # 730 (SSI # F1h DAh)

Select an option to determine which type of coupon format to support.

- Select **Old Coupon Format** to support UPC-A/GS1-128 and EAN-13/GS1-128.
- Select **New Coupon Format** as an interim format to support UPC-A/GS1-DataBar and EAN-13/GS1-DataBar.
- If you select **Autodiscriminate Format**, the RS6000 supports both **Old Coupon Format** and **New Coupon Format**.



Old Coupon Format
(0)

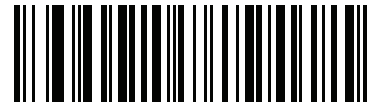

***New Coupon Format**
(1)



Autodiscriminate Coupon Format
(2)

ISSN EAN

Parameter # 617 (SSI # F1h 69h)

To enable or disable ISSN EAN, scan the appropriate bar code below.



Enable ISSN EAN
(1)



***Disable ISSN EAN**
(0)

Code 128

Enable/Disable Code 128

Parameter # 8 (SSI # 08h)

To enable or disable Code 128, scan the appropriate bar code below.

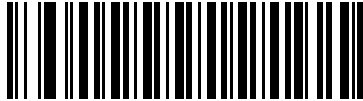

***Enable Code 128
(1)**

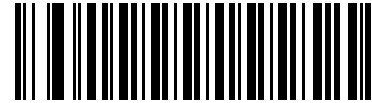

**Disable Code 128
(0)**

Set Lengths for Code 128

Parameter # L1 = 209 (SSI # D1h), L2 = 210 (SSI # D2h)

The length of a code refers to the number of characters (i.e., human readable characters), including check digit(s) the code contains. Set lengths for Code 128 to any length, one or two discrete lengths, or lengths within a specific range. The default is 1 to 55.



NOTE: When setting lengths for different bar code types, enter a leading zero for single digit numbers.

- **One Discrete Length** - Select this option to decode only Code 128 symbols containing a selected length. Select the length using the numeric bar codes in [Alphanumeric and Numeric Bar Codes](#). For example, to decode only Code 128 symbols with 14 characters, scan **Code 128 - One Discrete Length**, then scan **1** followed by **4**. To correct an error or change the selection, scan [Cancel on page 329](#).
- **Two Discrete Lengths** - Select this option to decode only Code 128 symbols containing either of two selected lengths. Select lengths using the numeric bar codes in [Alphanumeric and Numeric Bar Codes](#). For example, to decode only Code 128 symbols containing either 2 or 14 characters, select **Code 128 - Two Discrete Lengths**, then scan **0, 2, 1**, and then **4**. To correct an error or change the selection, scan [Cancel on page 329](#).
- **Length Within Range** - Select this option to decode a Code 128 symbol with a specific length range. Select lengths using numeric bar codes in [Alphanumeric and Numeric Bar Codes](#). For example, to decode Code 128 symbols containing between 4 and 12 characters, first scan **Code 128 - Length Within Range**. Then scan **0, 4, 1**, and **2** (enter a leading zero for single digit numbers). To correct an error or change the selection, scan [Cancel on page 329](#).
- **Any Length** - Select this option to decode Code 128 symbols containing any number of characters within the RS6000's capability.

Set Lengths for Code 128 (continued)

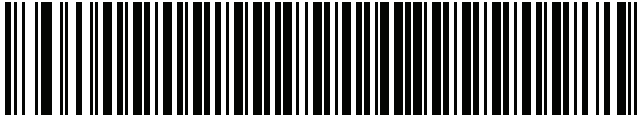

Code 128 - One Discrete Length

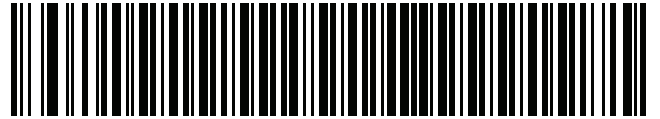

Code 128 - Two Discrete Lengths

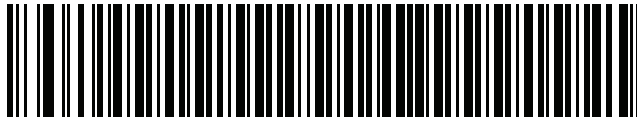

Code 128 - Length Within Range

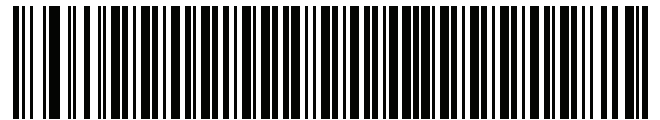

Code 128 - Any Length

Enable/Disable GS1-128 (formerly UCC/EAN-128)

Parameter # 14 (SSI # 0Eh)

To enable or disable GS1-128, scan the appropriate bar code below.

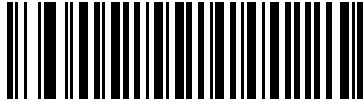

***Enable GS1-128
(1)**

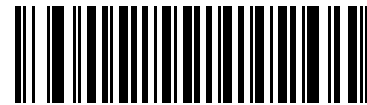

**Disable GS1-128
(0)**

Enable/Disable ISBT 128

Parameter # 84 (SSI # 54h)

ISBT 128 is a variant of Code 128 used in the blood bank industry. Scan a bar code below to enable or disable ISBT 128. If necessary, the host must perform concatenation of the ISBT data.



***Enable ISBT 128
(1)**

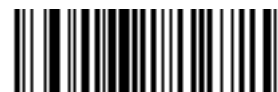

**Disable ISBT 128
(0)**

ISBT Concatenation

Parameter # 577 (SSI # F1h 41h)

Select an option for concatenating pairs of ISBT code types:

- If you select **Disable ISBT Concatenation**, the RS6000 does not concatenate pairs of ISBT codes it encounters.
- If you select **Enable ISBT Concatenation**, there must be two ISBT codes in order for the RS6000 to decode and perform concatenation. The RS6000 does not decode single ISBT symbols.
- If you select **Autodiscriminate ISBT Concatenation**, the RS6000 decodes and concatenates pairs of ISBT codes immediately. If only a single ISBT symbol is present, the RS6000 must decode the symbol the number of times set via [ISBT Concatenation Redundancy on page 173](#) before transmitting its data to confirm that there is no additional ISBT symbol.



**Disable ISBT Concatenation
(0)**

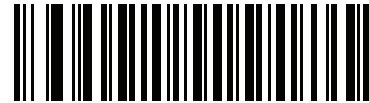

**Enable ISBT Concatenation
(1)**

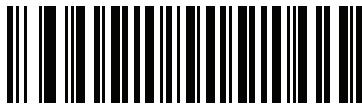

***Autodiscriminate ISBT Concatenation
(2)**

Check ISBT Table

Parameter # 578 (SSI # F1h 42h)

The ISBT specification includes a table that lists several types of ISBT bar codes that are commonly used in pairs. If you set **ISBT Concatenation** to **Enable**, enable **Check ISBT Table** to concatenate only those pairs found in this table. Other types of ISBT codes are not concatenated.



*Enable Check ISBT Table
(1)

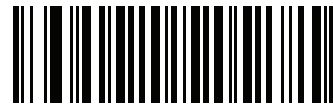

Disable Check ISBT Table
(0)

ISBT Concatenation Redundancy

Parameter # 223 (SSI # DFh)

If you set **ISBT Concatenation** to **Autodiscriminate**, use this parameter to set the number of times the RS6000 must decode an ISBT symbol before determining that there is no additional symbol.

Scan the bar code below, then scan two numeric bar codes in [Alphanumeric and Numeric Bar Codes](#) to set a value between 2 and 20. Enter a leading zero for single digit numbers. To correct an error or change a selection, scan [Cancel on page 329](#). The default is 10.



ISBT Concatenation Redundancy

Code 128 Security Level

Parameter # 751 (SSI # F1h EFh)

Code 128 bar codes are vulnerable to misdecodes, particularly when Code 128 Lengths is set to **Any Length**. The RS6000 offers four levels of decode security for Code 128 bar codes. There is an inverse relationship between security and RS6000 aggressiveness. Increasing the level of security can reduce scanning aggressiveness, so select only the level of security necessary.

- **Code 128 Security Level 0:** This setting allows the RS6000 to operate in its most aggressive state, while providing sufficient security in decoding most in-spec bar codes.
- **Code 128 Security Level 1:** A bar code must be successfully read twice, and satisfy certain safety requirements before being decoded. This default setting eliminates most misdecodes.
- **Code 128 Security Level 2:** Select this option with greater bar code security requirements if **Security Level 1** fails to eliminate misdecodes.
- **Code 128 Security Level 3:** If you selected **Security Level 2**, and misdecodes still occur, select this security level to apply the highest safety requirements. A bar code must be successfully read three times before being decoded.



NOTE: Selecting this option is an extreme measure against mis-decoding severely out-of-spec bar codes. Selecting this level of security significantly impairs the decoding ability of the RS6000. If this level of security is required, try to improve the quality of the bar codes.

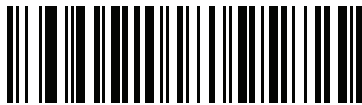

Code 128 Security Level 0
(0)

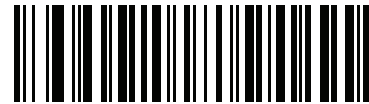

*Code 128 Security Level 1
(1)

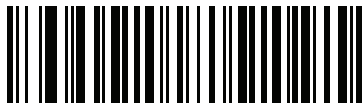

Code 128 Security Level 2
(2)



Code 128 Security Level 3
(3)

Code 128 Reduced Quiet Zone

Parameter # 1208 (SSI # F8h 04h B8h)

Scan one of the following bar codes to enable or disable decoding Code 128 bar codes with reduced quiet zones. If you select **Enable**, select a [1D Quiet Zone Level on page 243](#).



**Enable Code 128 Reduced Quiet Zone
(1)**



***Disable Code 128 Reduced Quiet Zone
(0)**

Ignore Code 128 <FNC4>

Parameter # 1254 (SSI # F8h 04h E6h)

This feature applies to Code 128 bar codes with an embedded <FNC4> character. Enable this to strip the <FNC4> character from the decode data. The remaining characters are sent to the host unchanged. When disabled, the <FNC4> character is processed normally as per Code 128 standard.



**Enable Ignore Code 128 <FNC4>
(1)**



***Disable Ignore Code 128 <FNC4>
(0)**

Code 128 Exclusive

Parameter # 673 (SSI # SSI F1h A1h)

This feature only allows decoding of bar code matching the Code 128 Exclusive format.



Enable
(1)



***Disable**
(0)

Code 39

Enable/Disable Code 39

Parameter # 0 (SSI # 00h)

To enable or disable Code 39, scan the appropriate bar code below.



***Enable Code 39**
(1)

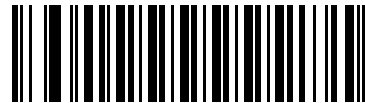

Disable Code 39
(0)

Enable/Disable Trioptic Code 39

Parameter # 13 (SSI # 0Dh)

Trioptic Code 39 is a variant of Code 39 used in the marking of computer tape cartridges. Trioptic Code 39 symbols always contain six characters. To enable or disable Trioptic Code 39, scan the appropriate bar code below.

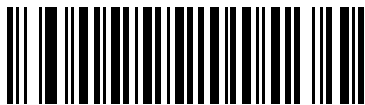

Enable Trioptic Code 39
(1)



***Disable Trioptic Code 39**
(0)



NOTE: You cannot enable Trioptic Code 39 and Code 39 Full ASCII simultaneously.

Convert Code 39 to Code 32

Parameter # 86 (SSI # 56h)

Code 32 is a variant of Code 39 used by the Italian pharmaceutical industry. Scan the appropriate bar code below to enable or disable converting Code 39 to Code 32.

✓ **NOTE:** Code 39 must be enabled for this parameter to function.

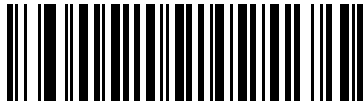

Enable Convert Code 39 to Code 32
(1)

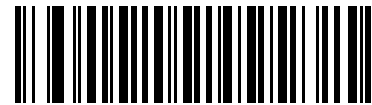

***Disable Convert Code 39 to Code 32**
(0)

Code 32 Prefix

Parameter # 231 (SSI # E7h)

Scan the appropriate bar code below to enable or disable adding the prefix character “A” to all Code 32 bar codes.

✓ **NOTE:** Convert Code 39 to Code 32 must be enabled for this parameter to function.



**Enable Code 32 Prefix
(1)**

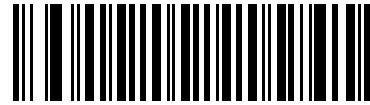

***Disable Code 32 Prefix
(0)**

Set Lengths for Code 39

Parameter # L1 = 18 (SSI # 12h), L2 = 19 (SSI # 13h)

The length of a code refers to the number of characters (i.e., human readable characters), including check digit(s) the code contains. Set lengths for Code 39 to any length, one or two discrete lengths, or lengths within a specific range. If Code 39 Full ASCII is enabled, **Length Within a Range** or **Any Length** are the preferred options. The default is 1 to 55.



NOTE: When setting lengths for different bar code types, enter a leading zero for single digit numbers.

- **One Discrete Length** - Select this option to decode only Code 39 symbols containing a selected length. Select the length using the numeric bar codes in [Alphanumeric and Numeric Bar Codes](#). For example, to decode only Code 39 symbols with 14 characters, scan **Code 39 - One Discrete Length**, then scan **1** followed by **4**. To correct an error or change the selection, scan [Cancel on page 329](#).
- **Two Discrete Lengths** - Select this option to decode only Code 39 symbols containing either of two selected lengths. Select lengths using the numeric bar codes in [Alphanumeric and Numeric Bar Codes](#). For example, to decode only Code 39 symbols containing either 2 or 14 characters, select **Code 39 - Two Discrete Lengths**, then scan **0, 2, 1**, and then **4**. To correct an error or change the selection, scan [Cancel on page 329](#).
- **Length Within Range** - Select this option to decode a Code 39 symbol with a specific length range. Select lengths using numeric bar codes in [Alphanumeric and Numeric Bar Codes](#). For example, to decode Code 39 symbols containing between 4 and 12 characters, first scan **Code 39 - Length Within Range**. Then scan **0, 4, 1**, and **2** (enter a leading zero for single digit numbers). To correct an error or change the selection, scan [Cancel on page 329](#).
- **Any Length** - Select this option to decode Code 39 symbols containing any number of characters within the RS6000's capability.



Code 39 - One Discrete Length



Code 39 - Two Discrete Lengths



Code 39 - Length Within Range



Code 39 - Any Length

Code 39 Check Digit Verification

Parameter # 48 (SSI # 30h)

Enable this feature to check the integrity of all Code 39 symbols to verify that the data complies with specified check digit algorithm. Only Code 39 symbols which include a modulo 43 check digit are decoded. Enable this feature if the Code 39 symbols contain a Modulo 43 check digit.

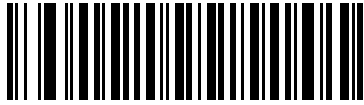

Enable Code 39 Check Digit
(1)

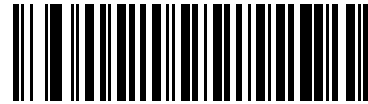

*Disable Code 39 Check Digit
(0)

Transmit Code 39 Check Digit

Parameter # 43 (SSI # 2Bh)

Scan a bar code below to transmit Code 39 data with or without the check digit.

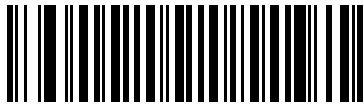

Transmit Code 39 Check Digit (Enable)
(1)



*Do Not Transmit Code 39 Check Digit (Disable)
(0)



NOTE: Code 39 Check Digit Verification must be enabled for this parameter to function.

Code 39 Full ASCII Conversion

Parameter # 17 (SSI # 11h)

Code 39 Full ASCII is a variant of Code 39 which pairs characters to encode the full ASCII character set. To enable or disable Code 39 Full ASCII, scan the appropriate bar code below.

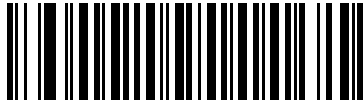

**Enable Code 39 Full ASCII
(1)**

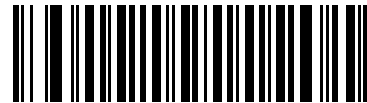

***Disable Code 39 Full ASCII
(0)**



NOTE: You cannot enable Trioptic Code 39 and Code 39 Full ASCII simultaneously.

Code 39 Full ASCII to Full ASCII Correlation is host-dependent, and is therefore described in the ASCII Character Set Table for the appropriate interface. See the [ASCII Character Sets on page 389](#).

Code 39 Security Level

Parameter # 750 (SSI # F1h EEh)

The RS6000 offers four levels of decode security for Code 39 bar codes. There is an inverse relationship between security and RS6000 aggressiveness. Increasing the level of security can reduce scanning aggressiveness, so select only the level of security necessary.

- **Code 39 Security Level 0:** This setting allows the RS6000 to operate in its most aggressive state, while providing sufficient security in decoding most in-spec bar codes.
- **Code 39 Security Level 1:** This default setting eliminates most misdecodes.
- **Code 39 Security Level 2:** Select this option with greater bar code security requirements if **Security Level 1** fails to eliminate misdecodes.
- **Code 39 Level 3:** If you selected **Security Level 2**, and misdecodes still occur, select this security level to apply the highest safety requirements.



NOTE: Selecting this option is an extreme measure against mis-decoding severely out-of-spec bar codes. Selecting this level of security significantly impairs the decoding ability of the RS6000. If this level of security is required, try to improve the quality of the bar codes.

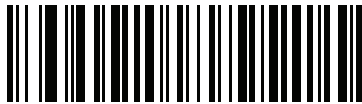

Code 39 Security Level 0
(0)



*Code 39 Security Level 1
(1)



Code 39 Security Level 2
(2)



Code 39 Security Level 3
(3)

Code 39 Reduced Quiet Zone

Parameter # 1209 (SSI # F8h 04h B9h)

Scan one of the following bar codes to enable or disable decoding Code 39 bar codes with reduced quiet zones. If you select **Enable**, select a [1D Quiet Zone Level on page 243](#).



Enable Code 39 Reduced Quiet Zone
(1)

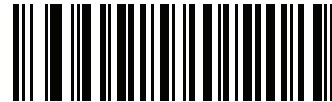

***Disable Code 39 Reduced Quiet Zone**
(0)

Code 39 Buffering - Scan & Store

Parameter # 113 (SSI # 71h)

This feature allows the digital scanner to accumulate data from multiple Code 39 symbols.

Selecting the Scan and Store option (Buffer Code 39) temporarily buffers all Code 39 symbols having a leading space as a first character for later transmission. The leading space is not buffered.

Decoding a Code 39 symbol with no leading space transmits in sequence all buffered data in a first-in first-out format, plus the “triggering” symbol. See the following pages for further details.

Select **Do Not Buffer Code 39** to transmit all decoded Code 39 symbols immediately without storing them in the buffer.

Code 39 Buffering - Scan & Store (continued)

This feature affects Code 39 only. If selecting **Buffer Code 39**, we recommend configuring the digital scanner to decode Code 39 symbology only.

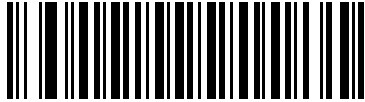

Buffer Code 39 (Enable)
(01h)

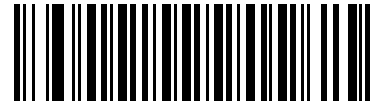

***Do Not Buffer Code 39 (Disable)**
(00h)

While there is data in the transmission buffer, you cannot select **Do Not Buffer Code 39**. The buffer holds 200 bytes of information.

To disable Code 39 buffering when there is data in the transmission buffer, first force the buffer transmission (see [Transmit Buffer on page 186](#)) or clear the buffer.

Buffer Data

To buffer data, enable Code 39 buffering and scan a Code 39 symbol with a space immediately following the start pattern.

- Unless the data overflows the transmission buffer, the digital scanner issues a low/high beep to indicate successful decode and buffering. (For overflow conditions, see [Overfilling Transmission Buffer on page 186](#).)
- The digital scanner adds the decoded data excluding the leading space to the transmission buffer.
- No transmission occurs.

Clear Transmission Buffer

To clear the transmission buffer, scan the **Clear Buffer** bar code below, which contains only a start character, a dash (minus), and a stop character.

- The digital scanner issues a short high/low/high beep.
- The digital scanner erases the transmission buffer.
- No transmission occurs.



Clear Buffer

✓ **NOTE:** The Clear Buffer contains only the dash (minus) character. In order to scan this command, set Code 39 lengths to include length 1.

Transmit Buffer

There are two methods to transmit the Code 39 buffer.

1. Scan the **Transmit Buffer** bar code below, which includes only a start character, a plus (+), and a stop character.
2. The digital scanner transmits and clears the buffer.
 - The digital scanner issues a low/high beep.



Transmit Buffer

3. Scan a Code 39 bar code with a leading character other than a space.
 - The digital scanner appends new decode data to buffered data.
 - The digital scanner transmits and clears the buffer.
 - The digital scanner signals that it transmitted the buffer with a low/high beep.
 - The digital scanner transmits and clears the buffer.

✓ **NOTE:** The Transmit Buffer contains only a plus (+) character. In order to scan this command, set Code 39 lengths to include length 1.

Overfilling Transmission Buffer

The Code 39 buffer holds 200 characters. If the symbol just read overflows the transmission buffer:

- The digital scanner indicates that it rejected the symbol by issuing three long, high beeps.
- No transmission occurs. The data in the buffer is not affected.

Attempt to Transmit an Empty Buffer

If you scan the **Transmit Buffer** symbol and the Code 39 buffer is empty:

- A short low/high/low beep signals that the buffer is empty.
- No transmission occurs.
- The buffer remains empty.

Code 93

Enable/Disable Code 93

Parameter # 9 (SSI # 09h)

To enable or disable Code 93, scan the appropriate bar code below.

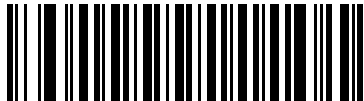

*Enable Code 93
(1)

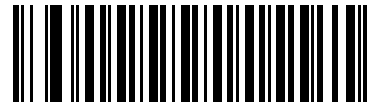

Disable Code 93
(0)

Set Lengths for Code 93

Parameter # L1 = 26 (SSI # 1Ah), L2 = 27 (SSI # 1Bh)

The length of a code refers to the number of characters (i.e., human readable characters), including check digit(s) the code contains. Set lengths for Code 93 to any length, one or two discrete lengths, or lengths within a specific range. The default is 1 to 55.

- **One Discrete Length** - Select this option to decode only Code 93 symbols containing a selected length. Select the length using the numeric bar codes in [Alphanumeric and Numeric Bar Codes](#). For example, to decode only Code 93 symbols with 14 characters, scan **Code 93 - One Discrete Length**, then scan **1** followed by **4**. To correct an error or to change the selection, scan [Cancel on page 329](#).
- **Two Discrete Lengths** - Select this option to decode only Code 93 symbols containing either of two selected lengths. Select lengths using the numeric bar codes in [Alphanumeric and Numeric Bar Codes](#). For example, to decode only Code 93 symbols containing either 2 or 14 characters, select **Code 93 - Two Discrete Lengths**, then scan **0, 2, 1**, and then **4**. To correct an error or to change the selection, scan [Cancel on page 329](#).
- **Length Within Range** - Select this option to decode a Code 93 symbol with a specific length range. Select lengths using the numeric bar codes in [Alphanumeric and Numeric Bar Codes](#). For example, to decode Code 93 symbols containing between 4 and 12 characters, first scan **Code 93 - Length Within Range**. Then scan **0, 4, 1**, and **2** (enter a leading zero for single digit numbers). To correct an error or change the selection, scan [Cancel on page 329](#).
- **Any Length** - Scan this option to decode Code 93 symbols containing any number of characters within the RS6000's capability.

Set Lengths for Code 93 (continued)



Code 93 - One Discrete Length



Code 93 - Two Discrete Lengths



Code 93 - Length Within Range



Code 93 - Any Length

Code 11

Code 11

Parameter # 10 (SSI # 0Ah)

To enable or disable Code 11, scan the appropriate bar code below.

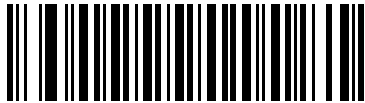

Enable Code 11
(1)

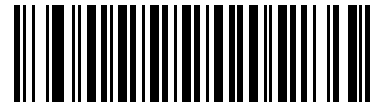

*Disable Code 11
(0)

Set Lengths for Code 11

Parameter # L1 = 28 (SSI # 1Ch), L2 = 29 (SSI # 1Dh)

The length of a code refers to the number of characters (i.e., human readable characters), including check digit(s) the code contains. Set lengths for Code 11 to any length, one or two discrete lengths, or lengths within a specific range. The default is 4 to 55.

- **One Discrete Length** - Select this option to decode only Code 11 symbols containing a selected length. Select the length using the numeric bar codes in [Alphanumeric and Numeric Bar Codes](#). For example, to decode only Code 11 symbols with 14 characters, scan **Code 11 - One Discrete Length**, then scan **1** followed by **4**. To correct an error or to change the selection, scan [Cancel on page 329](#).
- **Two Discrete Lengths** - Select this option to decode only Code 11 symbols containing either of two selected lengths. Select lengths using the numeric bar codes in [Alphanumeric and Numeric Bar Codes](#). For example, to decode only Code 11 symbols containing either 2 or 14 characters, select **Code 11 - Two Discrete Lengths**, then scan **0, 2, 1**, and then **4**. To correct an error or to change the selection, scan [Cancel on page 329](#).
- **Length Within Range** - Select this option to decode a Code 11 symbol with a specific length range. Select lengths using numeric bar codes in [Alphanumeric and Numeric Bar Codes](#). For example, to decode Code 11 symbols containing between 4 and 12 characters, first scan **Code 11 - Length Within Range**. Then scan **0, 4, 1**, and **2** (enter a leading zero for single digit numbers). To correct an error or change the selection, scan [Cancel on page 329](#).
- **Any Length** - Scan this option to decode Code 11 symbols containing any number of characters within the RS6000's capability.

Set Lengths for Code 11 (continued)



Code 11 - One Discrete Length



Code 11 - Two Discrete Lengths



Code 11 - Length Within Range



Code 11 - Any Length

Code 11 Check Digit Verification

Parameter # 52 (SSI # 34h)

This feature allows the RS6000 to check the integrity of all Code 11 symbols to verify that the data complies with the specified check digit algorithm. This selects the check digit mechanism for the decoded Code 11 bar code. The options are to check for one check digit, check for two check digits, or disable the feature.

To enable this feature, scan the bar code below corresponding to the number of check digits encoded in the Code 11 symbols.

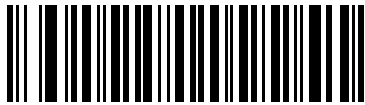

***Disable**
(0)



One Check Digit
(1)

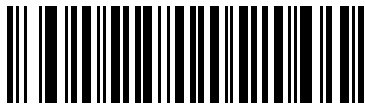

Two Check Digits
(2)

Transmit Code 11 Check Digits

Parameter # 47 (SSI # 2Fh)

This feature selects whether or not to transmit the Code 11 check digit(s).



Transmit Code 11 Check Digit(s) (Enable)
(1)

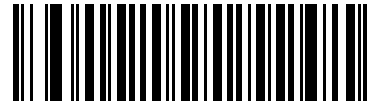

*Do Not Transmit Code 11 Check Digit(s) (Disable)
(0)



NOTE: Code 11 Check Digit Verification must be enabled for this parameter to function.

Interleaved 2 of 5 (ITF)

Enable/Disable Interleaved 2 of 5

Parameter # 6 (SSI # 06h)

To enable or disable Interleaved 2 of 5, scan the appropriate bar code below, and select an Interleaved 2 of 5 length from the following pages.

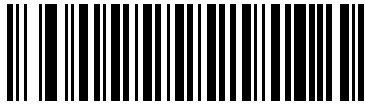

**Enable Interleaved 2 of 5
(1)**

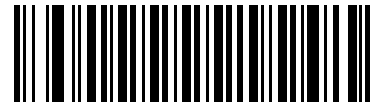

***Disable Interleaved 2 of 5
(0)**

Set Lengths for Interleaved 2 of 5

Parameter # L1 = 22 (SSI # 16h), L2 = 23 (SSI # 17h)

The length of a code refers to the number of characters (i.e., human readable characters), including check digit(s) the code contains. Set lengths for I 2 of 5 to any length, one or two discrete lengths, or lengths within a specific range. The range for Interleaved 2 of 5 lengths is 0 - 55. The default is 6 to 55.

- **One Discrete Length** - Select this option to decode only I 2 of 5 symbols containing a selected length. Select the length using the numeric bar codes in [Alphanumeric and Numeric Bar Codes](#). For example, to decode only I 2 of 5 symbols with 14 characters, scan **I 2 of 5 - One Discrete Length**, then scan **1** followed by **4**. To correct an error or to change the selection, scan [Cancel on page 329](#).
- **Two Discrete Lengths** - Select this option to decode only I 2 of 5 symbols containing either of two selected lengths. Select lengths using the numeric bar codes in [Alphanumeric and Numeric Bar Codes](#). For example, to decode only I 2 of 5 symbols containing either 2 or 14 characters, select **I 2 of 5 - Two Discrete Lengths**, then scan **0, 2, 1**, and then **4**. To correct an error or to change the selection, scan [Cancel on page 329](#).
- **Length Within Range** - Select this option to decode an I 2 of 5 symbol with a specific length range. Select lengths using numeric bar codes in [Alphanumeric and Numeric Bar Codes](#). For example, to decode I 2 of 5 symbols containing between 4 and 12 characters, first scan **I 2 of 5 - Length Within Range**. Then scan **0, 4, 1**, and **2** (enter a leading zero for single digit numbers). To correct an error or change the selection, scan [Cancel on page 329](#).
- **Any Length** - Scan this option to decode I 2 of 5 symbols containing any number of characters within the RS6000's capability.

✓ **NOTE:** Due to the construction of the I 2 of 5 symbology, it is possible for a scan line covering only a portion of the code to transmit as a complete scan, yielding less data than is encoded in the bar code. To prevent this, select specific lengths (I 2 of 5 - One Discrete Length, Two Discrete Lengths) for I 2 of 5 applications.

Set Lengths for Interleaved 2 of 5 (continued)



I 2 of 5 - One Discrete Length



I 2 of 5 - Two Discrete Lengths



I 2 of 5 - Length Within Range



I 2 of 5 - Any Length

I 2 of 5 Check Digit Verification

Parameter # 49 (SSI # 31h)

Enable this feature to check the integrity of all I 2 of 5 symbols to verify the data complies with either the specified Uniform Symbology Specification (USS), or the Optical Product Code Council (OPCC) check digit algorithm.



***Disable
(0)**



**USS Check Digit
(1)**



**OPCC Check Digit
(2)**

Transmit I 2 of 5 Check Digit

Parameter # 44 (SSI # 2Ch)

Scan the appropriate bar code below to transmit I 2 of 5 data with or without the check digit.



Transmit I 2 of 5 Check Digit (Enable)
(1)



*Do Not Transmit I 2 of 5 Check Digit (Disable)
(0)

Convert I 2 of 5 to EAN-13

Parameter # 82 (SSI # 52h)

Enable this parameter to convert 14-character I 2 of 5 codes to EAN-13, and transmit to the host as EAN-13. To accomplish this, the I 2 of 5 code must be enabled, and the code must have a leading zero and a valid EAN-13 check digit.

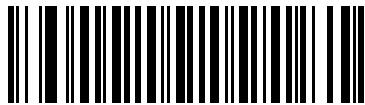

Convert I 2 of 5 to EAN-13 (Enable)
(1)



*Do Not Convert I 2 of 5 to EAN-13 (Disable)
(0)

I 2 of 5 Security Level

Parameter # 1121 (SSI # F8h 04h 61h)

Interleaved 2 of 5 bar codes are vulnerable to misdecodes, particularly when I 2 of 5 Lengths is set to **Any Length**. The RS6000 offers four levels of decode security for Interleaved 2 of 5 bar codes. There is an inverse relationship between security and RS6000 aggressiveness. Increasing the level of security can reduce scanning aggressiveness, so select only the level of security necessary.

- **I 2 of 5 Security Level 0:** This setting allows the RS6000 to operate in its most aggressive state, while providing sufficient security in decoding most in-spec bar codes.
- **I 2 of 5 Security Level 1:** A bar code must be successfully read twice, and satisfy certain safety requirements before being decoded. This default setting eliminates most misdecodes.
- **I 2 of 5 Security Level 2:** Select this option with greater bar code security requirements if **Security Level 1** fails to eliminate misdecodes.
- **I 2 of 5 Security Level 3:** If you selected **Security Level 2**, and misdecodes still occur, select this security level. The highest safety requirements are applied. A bar code must be successfully read three times before being decoded.



NOTE: Selecting this option is an extreme measure against mis-decoding severely out-of-spec bar codes. Selecting this level of security significantly impairs the decoding ability of the RS6000. If this level of security is required, try to improve the quality of the bar codes.

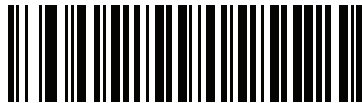

I 2 of 5 Security Level 0
(00h)



*I 2 of 5 Security Level 1
(01h)



I 2 of 5 Security Level 2
(02h)



I 2 of 5 Security Level 3
(03h)

I 2 of 5 Reduced Quiet Zone

Parameter # 1210 (SSI # F8h 04h BAh)

Scan one of the following bar codes to enable or disable decoding I 2 of 5 bar codes with reduced quiet zones. If you select **Enable**, select a [1D Quiet Zone Level on page 243](#).



**Enable I 2 of 5 Reduced Quiet Zone
(1)**

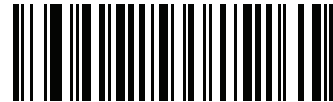

***Disable I 2 of 5 Reduced Quiet Zone
(0)**

Discrete 2 of 5 (DTF)

Enable/Disable Discrete 2 of 5

Parameter # 5 (SSI # 05h)

To enable or disable Discrete 2 of 5, scan the appropriate bar code below.

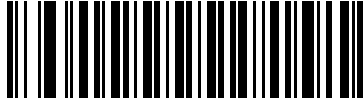

Enable Discrete 2 of 5
(1)



*Disable Discrete 2 of 5
(0)

Set Lengths for Discrete 2 of 5

Parameter # L1 = 20 (SSI # 14h), L2 = 21 (SSI # 15h)

The length of a code refers to the number of characters (i.e., human readable characters), including check digit(s) the code contains. Set lengths for D 2 of 5 to any length, one or two discrete lengths, or lengths within a specific range. The range for Discrete 2 of 5 lengths is 1 - 55.

- **One Discrete Length** - Select this option to decode only D 2 of 5 symbols containing a selected length. Select the length using the numeric bar codes in [Alphanumeric and Numeric Bar Codes](#). For example, to decode only D 2 of 5 symbols with 14 characters, scan **D 2 of 5 - One Discrete Length**, then scan **1** followed by **4**. To correct an error or to change the selection, scan [Cancel on page 329](#).
- **Two Discrete Lengths** - Select this option to decode only D 2 of 5 symbols containing either of two selected lengths. Select lengths using the numeric bar codes in [Alphanumeric and Numeric Bar Codes](#). For example, to decode only D 2 of 5 symbols containing either 2 or 14 characters, select **D 2 of 5 - Two Discrete Lengths**, then scan **0, 2, 1**, and then **4**. To correct an error or to change the selection, scan [Cancel on page 329](#).
- **Length Within Range** - Select this option to decode a D 2 of 5 symbol with a specific length range. Select lengths using numeric bar codes in [Alphanumeric and Numeric Bar Codes](#). For example, to decode D 2 of 5 symbols containing between 4 and 12 characters, first scan **D 2 of 5 - Length Within Range**. Then scan **0, 4, 1**, and **2** (enter a leading zero for single digit numbers). To correct an error or change the selection, scan [Cancel on page 329](#).
- **Any Length** - Scan this option to decode D 2 of 5 symbols containing any number of characters within the RS6000's capability.

✓ **NOTE:** Due to the construction of the D 2 of 5 symbology, it is possible for a scan line covering only a portion of the code to transmit as a complete scan, yielding less data than is encoded in the bar code. To prevent this, select specific lengths (**D 2 of 5 - One Discrete Length, Two Discrete Lengths**) for D 2 of 5 applications.

Set Lengths for Discrete 2 of 5 (continued)



D 2 of 5 - One Discrete Length



D 2 of 5 - Two Discrete Lengths



D 2 of 5 - Length Within Range



D 2 of 5 - Any Length

Codabar (NW - 7)

Enable/Disable Codabar

Parameter # 7 (SSI # 07h)

To enable or disable Codabar, scan the appropriate bar code below.

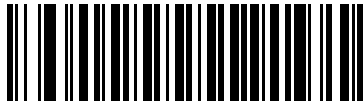

*Enable Codabar
(1)

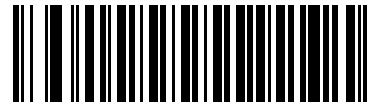

Disable Codabar
(0)

Set Lengths for Codabar

Parameter # L1 = 24 (SSI # 18h), L2 = 25 (SSI # 19h)

The length of a code refers to the number of characters (i.e., human readable characters), including check digit(s) the code contains. Set lengths for Codabar to any length, one or two discrete lengths, or lengths within a specific range. The default is 4 to 55.

- **One Discrete Length** - Select this option to decode only Codabar symbols containing a selected length. Select the length using the numeric bar codes in [Alphanumeric and Numeric Bar Codes](#). For example, to decode only Codabar symbols with 14 characters, scan **Codabar - One Discrete Length**, then scan **1** followed by **4**. To correct an error or to change the selection, scan [Cancel on page 329](#).
- **Two Discrete Lengths** - Select this option to decode only Codabar symbols containing either of two selected lengths. Select lengths using the numeric bar codes in [Alphanumeric and Numeric Bar Codes](#). For example, to decode only Codabar symbols containing either 2 or 14 characters, select **Codabar - Two Discrete Lengths**, then scan **0, 2, 1**, and then **4**. To correct an error or to change the selection, scan [Cancel on page 329](#).
- **Length Within Range** - Select this option to decode a Codabar symbol with a specific length range. Select lengths using numeric bar codes in [Alphanumeric and Numeric Bar Codes](#). For example, to decode Codabar symbols containing between 4 and 12 characters, first scan **Codabar - Length Within Range**. Then scan **0, 4, 1**, and **2** (enter a leading zero for single digit numbers). To correct an error or change the selection, scan [Cancel on page 329](#).
- **Any Length** - Scan this option to decode Codabar symbols containing any number of characters within the RS6000's capability.

Set Lengths for Codabar (continued)



Codabar - One Discrete Length



Codabar - Two Discrete Lengths



Codabar - Length Within Range



Codabar - Any Length

CLSI Editing

Parameter # 54 (SSI # 36h)

Enable this parameter to strip the start and stop characters and insert a space after the first, fifth, and tenth characters of a 14-character Codabar symbol. Enable this feature if the host system requires this data format.

✓ **NOTE:** Symbol length does not include start and stop characters.

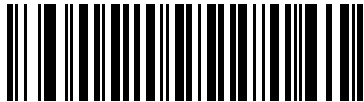

**Enable CLSI Editing
(1)**

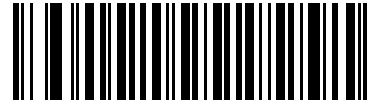

***Disable CLSI Editing
(0)**

NOTIS Editing

Parameter # 55 (SSI # 37h)

Enable this parameter to strip the start and stop characters from a decoded Codabar symbol. Enable this feature if the host system requires this data format.

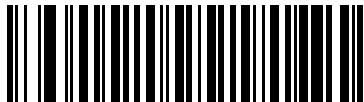

**Enable NOTIS Editing
(1)**



***Disable NOTIS Editing
(0)**

Codabar Upper or Lower Case Start/Stop Characters Detection

Parameter # 855 (SSI # F2h 57h)

Select whether to detect upper case or lower case Codabar start/stop characters.



Lower Case
(1)

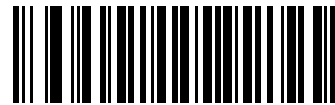

*Upper Case
(0)

MSI

Enable/Disable MSI

Parameter # 11 (SSI # 0Bh)

To enable or disable MSI, scan the appropriate bar code below.

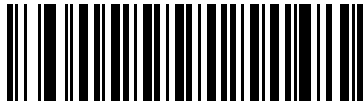

**Enable MSI
(1)**

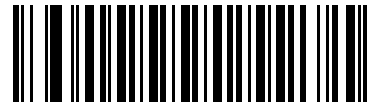

***Disable MSI
(0)**

Set Lengths for MSI

Parameter # L1 = 30 (SSI # 1Eh), L2 = 31 (SSI # 1Fh)

The length of a code refers to the number of characters (i.e., human readable characters), including check digit(s) the code contains. Set lengths for MSI to any length, one or two discrete lengths, or lengths within a specific range. The default is 4 to 55.

- **One Discrete Length** - Select this option to decode only MSI symbols containing a selected length. Select the length using the numeric bar codes in [Alphanumeric and Numeric Bar Codes](#). For example, to decode only MSI symbols with 14 characters, scan **MSI - One Discrete Length**, then scan **1** followed by **4**. To correct an error or to change the selection, scan [Cancel on page 329](#).
- **Two Discrete Lengths** - Select this option to decode only MSI symbols containing either of two selected lengths. Select lengths using the numeric bar codes in [Alphanumeric and Numeric Bar Codes](#). For example, to decode only MSI symbols containing either 2 or 14 characters, select **MSI - Two Discrete Lengths**, then scan **0, 2, 1**, and then **4**. To correct an error or to change the selection, scan [Cancel on page 329](#).
- **Length Within Range** - Select this option to decode a MSI symbol with a specific length range. Select lengths using numeric bar codes in [Alphanumeric and Numeric Bar Codes](#). For example, to decode MSI symbols containing between 4 and 12 characters, first scan **MSI - Length Within Range**. Then scan **0, 4, 1**, and **2** (enter a leading zero for single digit numbers). To correct an error or change the selection, scan [Cancel on page 329](#).
- **Any Length** - Scan this option to decode MSI symbols containing any number of characters within the RS6000's capability.

Set Lengths for MSI (continued)

- ✓ **NOTE:** Due to the construction of the MSI symbology, it is possible for a scan line covering only a portion of the code to transmit as a complete scan, yielding less data than is encoded in the bar code. To prevent this, select specific lengths (**MSI - One Discrete Length, Two Discrete Lengths**) for MSI applications.



MSI - One Discrete Length



MSI - Two Discrete Lengths



MSI - Length Within Range

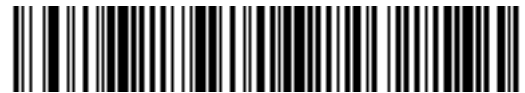

MSI - Any Length

MSI Check Digits

Parameter # 50 (SSI # 32h)

With MSI symbols, one check digit is mandatory and always verified by the reader. The second check digit is optional. If the MSI codes include two check digits, scan the **Two MSI Check Digits** bar code to enable verification of the second check digit.

See [MSI Check Digit Algorithm on page 210](#) for the selection of second digit algorithms.

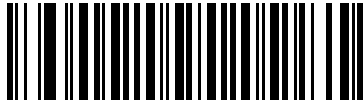

***One MSI Check Digit
(0)**

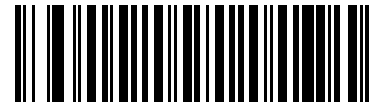

**Two MSI Check Digits
(1)**

Transmit MSI Check Digit(s)

Parameter # 46 (SSI # 2Eh)

Scan a bar code below to transmit MSI data with or without the check digit.



**Transmit MSI Check Digit(s) (Enable)
(1)**

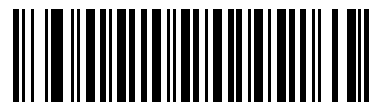

***Do Not Transmit MSI Check Digit(s) (Disable)
(0)**

MSI Check Digit Algorithm

Parameter # 51 (SSI # 33h)

Two algorithms are possible for the verification of the second MSI check digit. Select the bar code below corresponding to the algorithm used to encode the check digit.

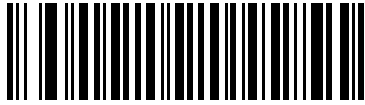

**MOD 10/MOD 11
(0)**

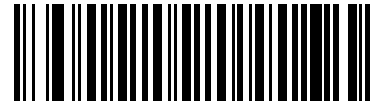

***MOD 10/MOD 10
(1)**

Chinese 2 of 5

Enable/Disable Chinese 2 of 5

Parameter # 408 (SSI # F0h 98h)

To enable or disable Chinese 2 of 5, scan the appropriate bar code below.



**Enable Chinese 2 of 5
(1)**

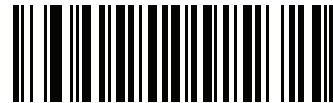

***Disable Chinese 2 of 5
(0)**

Matrix 2 of 5

Enable/Disable Matrix 2 of 5

Parameter # 618 (SSI # F1h 6Ah)

To enable or disable Matrix 2 of 5, scan the appropriate bar code below.

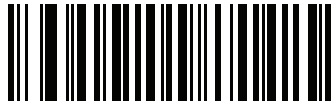

Enable Matrix 2 of 5
(1)



*Disable Matrix 2 of 5
(0)

Set Lengths for Matrix 2 of 5

Parameter # L1 = 619 (SSI # F1h 6Bh), L2 = 620 (SSI # F1h 6Ch)

The length of a code refers to the number of characters (i.e., human readable characters), including check digit(s) the code contains. Set lengths for Matrix 2 of 5 to any length, one or two discrete lengths, or lengths within a specific range. The default is 4 to 55.

- **One Discrete Length** - Select this option to decode only Matrix 2 of 5 symbols containing a selected length. Select the length using the numeric bar codes in [Alphanumeric and Numeric Bar Codes](#). For example, to decode only Matrix 2 of 5 symbols with 14 characters, scan **Matrix 2 of 5 - One Discrete Length**, then scan **1** followed by **4**. To correct an error or to change the selection, scan [Cancel on page 329](#).
- **Two Discrete Lengths** - Select this option to decode only Matrix 2 of 5 symbols containing either of two selected lengths. Select lengths using the numeric bar codes in [Alphanumeric and Numeric Bar Codes](#). For example, to decode only Matrix 2 of 5 symbols containing either 2 or 14 characters, select **Matrix 2 of 5 - Two Discrete Lengths**, then scan **0, 2, 1**, and then **4**. To correct an error or to change the selection, scan [Cancel on page 329](#).
- **Length Within Range** - Select this option to decode a Matrix 2 of 5 symbol with a specific length range. Select lengths using the numeric bar codes in [Alphanumeric and Numeric Bar Codes](#). For example, to decode Matrix 2 of 5 symbols containing between 4 and 12 characters, first scan **Matrix 2 of 5 - Length Within Range**. Then scan **0, 4, 1**, and **2** (enter a leading zero for single digit numbers). To correct an error or change the selection, scan [Cancel on page 329](#).
- **Any Length** - Scan this option to decode Matrix 2 of 5 symbols containing any number of characters within the RS6000's capability.

Set Lengths for Matrix 2 of 5 (continued)



*Matrix 2 of 5 - One Discrete Length



Matrix 2 of 5 - Two Discrete Lengths



Matrix 2 of 5 - Length Within Range



Matrix 2 of 5 - Any Length

Matrix 2 of 5 Check Digit

Parameter # 622 (SSI # F1h 6Eh)

The check digit is the last character of the symbol used to verify the integrity of the data. Scan the appropriate bar code below to transmit the bar code data with or without the Matrix 2 of 5 check digit.



**Enable Matrix 2 of 5 Check Digit
(1)**



***Disable Matrix 2 of 5 Check Digit
(0)**

Transmit Matrix 2 of 5 Check Digit

Parameter # 623 (SSI # F1h 6Fh)

Scan a bar code below to transmit Matrix 2 of 5 data with or without the check digit.

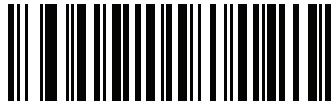

**Transmit Matrix 2 of 5 Check Digit
(1)**



***Do Not Transmit Matrix 2 of 5 Check Digit
(0)**

Korean 3 of 5

Enable/Disable Korean 3 of 5

Parameter # 581 (SSI # F1h 45h)

To enable or disable Korean 3 of 5, scan the appropriate bar code below.

✓ **NOTE:** The length for Korean 3 of 5 is fixed at 6.

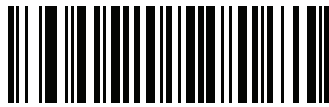

**Enable Korean 3 of 5
(1)**



***Disable Korean 3 of 5
(0)**

Inverse 1D

Parameter # 586 (SSI # F1h 4Ah)

This parameter sets the 1D inverse decoder setting. Options are:

- **Regular Only** - the RS6000 decodes regular 1D bar codes only.
- **Inverse Only** - the RS6000 decodes inverse 1D bar codes only.
- **Inverse Autodetect** - the RS6000 decodes both regular and inverse 1D bar codes.



***Regular**
(0)



Inverse Only
(1)



Inverse Autodetect
(2)

GS1 DataBar

The variants of GS1 DataBar are DataBar-14, DataBar Expanded, and DataBar Limited. The limited and expanded versions have stacked variants. Scan the appropriate bar codes to enable or disable each variant of GS1 DataBar.

GS1 DataBar-14

Parameter # 338 (SSI # F0h 52h)

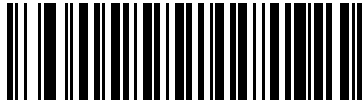

***Enable GS1 DataBar-14
(1)**

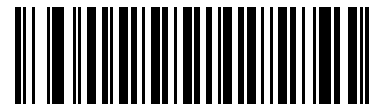

**Disable GS1 DataBar-14
(0)**

GS1 DataBar Limited

Parameter # 339 (SSI # F0h 53h)

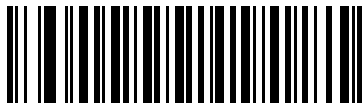

***Enable GS1 DataBar Limited
(1)**



**Disable GS1 DataBar Limited
(0)**

GS1 DataBar Expanded**Parameter # 340 (SSI # F0h 54h)**

***Enable GS1 DataBar Expanded
(1)**

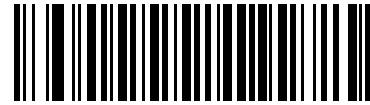

**Disable GS1 DataBar Expanded
(0)**

Convert GS1 DataBar to UPC/EAN**Parameter # 397 (SSI # F0h, 8Dh)**

This parameter only applies to GS1 DataBar-14 and GS1 DataBar Limited symbols not decoded as part of a Composite symbol. Enable this to strip the leading '010' from DataBar-14 and DataBar Limited symbols encoding a single zero as the first digit, and report the bar code as EAN-13.

For bar codes beginning with two or more zeros but not six zeros, this parameter strips the leading '0100' and reports the bar code as UPC-A. The UPC-A Preamble parameter that transmits the system character and country code applies to converted bar codes. Note that neither the system character nor the check digit can be stripped.



**Enable Convert GS1 DataBar to UPC/EAN
(1)**



***Disable Convert GS1 DataBar to UPC/EAN
(0)**

GS1 DataBar Limited Security Level

Parameter # 728 (SSI # F1h D8h)

The RS6000 offers four levels of decode security for GS1 DataBar Limited bar codes. There is an inverse relationship between security and RS6000 aggressiveness. Increasing the level of security may result in reduced aggressiveness in scanning, so choose only that level of security necessary.

- Level 1 – No clear margin required. This complies with the original GS1 standard, yet might result in erroneous decoding of the DataBar Limited bar code when scanning some UPC symbols that start with digits “9” and “7”
- Level 2 – Automatic risk detection. This level of security may result in erroneous decoding of DataBar Limited bar codes when scanning some UPC symbols. The RS6000 defaults to Level 3, otherwise to Level 1.
- Level 3 – Security level reflects newly proposed GS1 standard that requires a 5 times trailing clear margin.
- Level 4 – Security level extends beyond the standard required by GS1. This level of security requires a 5 times leading and trailing clear margin.



GS1 DataBar Limited Security Level 1
(1)

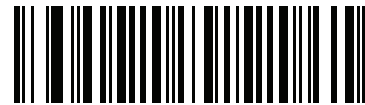

GS1 DataBar Limited Security Level 2
(2)



***GS1 DataBar Limited Security Level 3**
(3)



GS1 DataBar Limited Security Level 4
(4)

Composite

Composite CC-C

Parameter # 341 (SSI # F0h 55h)

Scan a bar code below to enable or disable Composite bar codes of type CC-C.

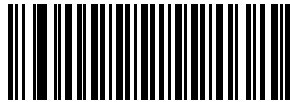

Enable CC-C
(1)

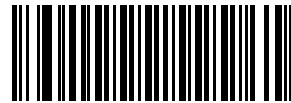

*Disable CC-C
(0)

Composite CC-A/B

Parameter # 342 (SSI # F0h 56h)

Scan a bar code below to enable or disable Composite bar codes of type CC-A/B.



Enable CC-A/B
(1)



*Disable CC-A/B
(0)

Composite TLC-39

Parameter # 371 (SSI # F0h 73h)

Scan a bar code below to enable or disable Composite bar codes of type TLC-39.



Enable TLC39
(1)



*Disable TLC39
(0)

UPC Composite Mode

Parameter # 344 (SSI # F0h 58h)

Select an option for linking UPC symbols with a 2D symbol during transmission as if they were one symbol:

- Select **UPC Never Linked** to transmit UPC bar codes regardless of whether a 2D symbol is detected.
- Select **UPC Always Linked** to transmit UPC bar codes and the 2D portion. If 2D is not present, the UPC bar code does not transmit.
- If you select **Autodiscriminate UPC Composites**, the RS6000 determines if there is a 2D portion, then transmits the UPC, as well as the 2D portion if present.

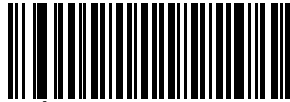

*UPC Never Linked
(0)

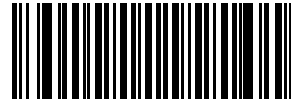

UPC Always Linked
(1)

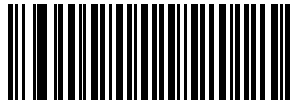

Autodiscriminate UPC Composites
(2)

Composite Beep Mode

Parameter # 398 (SSI # F0h, 8Eh)

To select the number of decode beeps when a composite bar code is decoded, scan the appropriate bar code.



Single Beep after both are decoded
(0)

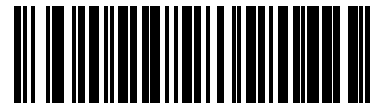

*Beep as each code type is decoded
(1)

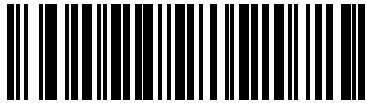

Double Beep after both are decoded
(2)

GS1-128 Emulation Mode for UCC/EAN Composite Codes

Parameter # 427 (SSI # F0h, ABh)

Select whether to enable or disable this mode.



Enable GS1-128 Emulation Mode for
UCC/EAN Composite Codes
(1)



*Disable GS1-128 Emulation Mode for
UCC/EAN Composite Codes
(0)

2D Symbologies

Enable/Disable PDF417

Parameter # 15 (SSI # 0Fh)

To enable or disable PDF417, scan the appropriate bar code below.



***Enable PDF417**
(1)



Disable PDF417
(0)

Enable/Disable MicroPDF417

Parameter # 227 (SSI # E3h)

To enable or disable MicroPDF417, scan the appropriate bar code below.



Enable MicroPDF417
(1)

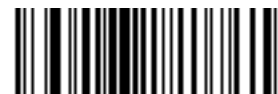

***Disable MicroPDF417**
(0)

Code 128 Emulation

Parameter # 123 (SSI # 7Bh)

Enable this parameter to transmit data from certain MicroPDF417 symbols as Code 128. [AIM Code ID Character on page 136](#) must be enabled for this parameter to work.

Enable Code 128 Emulation to transmit these MicroPDF417 symbols with one of the following prefixes:

-]C1 if the first codeword is 903-905
-]C2 if the first codeword is 908 or 909
-]C0 if the first codeword is 910 or 911

Disable Code 128 Emulation to transmit these MicroPDF417 symbols with one of the following prefixes:

-]L3 if the first codeword is 903-905
-]L4 if the first codeword is 908 or 909
-]L5 if the first codeword is 910 or 911

Scan a bar code below to enable or disable Code 128 Emulation.



NOTE: Linked MicroPDF codewords 906, 907, 912, 914, and 915 are not supported. Use GS1 Composites instead.



Enable Code 128 Emulation
(1)



*Disable Code 128 Emulation
(0)

Data Matrix

Parameter # 292 (SSI # F0h, 24h)

To enable or disable Data Matrix, scan the appropriate bar code below.



***Enable Data Matrix
(1)**



**Disable Data Matrix
(0)**

GS1 Data Matrix

Parameter # 1336 (SSI # F8h 05h 38h)

To enable or disable GS1 Data Matrix, scan the appropriate bar code below.

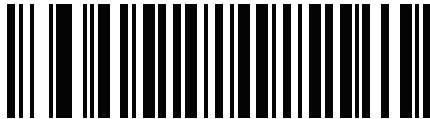

***Disable GS1 Data Matrix
(0)**

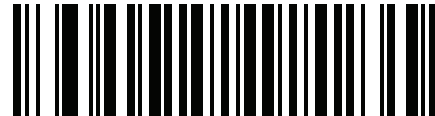

**Enable GS1 Data Matrix
(1)**

Data Matrix Inverse

Parameter # 588 (SSI # F1h 4Ch)

This parameter sets the Data Matrix inverse decoder setting. Options are:

- **Regular Only** - the RS6000 decodes regular Data Matrix bar codes only.
- **Inverse Only** - the RS6000 decodes inverse Data Matrix bar codes only.
- **Inverse Autodetect** - the RS6000 decodes both regular and inverse Data Matrix bar codes.



Regular
(0)



Inverse Only
(1)



*Inverse Autodetect
(2)

Maxicode

Parameter # 294 (SSI # F0h, 26h)

To enable or disable Maxicode, scan the appropriate bar code below.



Enable Maxicode
(1)



*Disable Maxicode
(0)

QR Code

Parameter # 293 (SSI # F0h, 25h)

✓ **NOTE:** Inverse QR bar codes decode if **QR Code** is enabled.

To enable or disable QR Code, scan the appropriate bar code below.

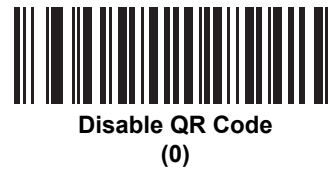
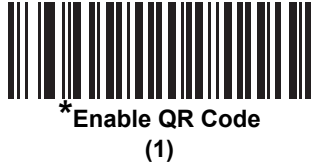

GS1 QR

Parameter # 1343 (SSI # F8h 05h 3Fh)

To enable or disable GS1 QR, scan the appropriate bar code below.

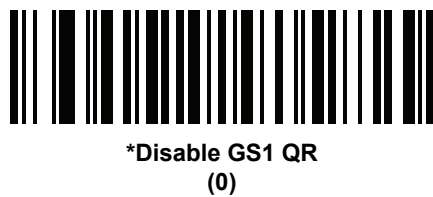

MicroQR

Parameter # 573 (SSI # F1h 3Dh)

To enable or disable MicroQR, scan the appropriate bar code below.

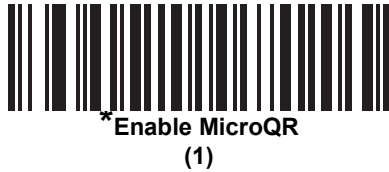

Inverse QR

Parameter # 587 (SSI F1h 4Bh)

This parameter sets the QR inverse decoder setting. Options are:

- **Regular Only** - the RS6000 decodes regular QR bar codes only.
- **Inverse Only** - the RS6000 decodes inverse QR bar codes only.
- **Inverse Auto Detect** - the RS6000 decodes both regular and inverse QR bar codes.



Aztec

Parameter # 574 (SSI # F1h 3Eh)

To enable or disable Aztec, scan the appropriate bar code below.



Aztec Inverse

Parameter # 589 (SSI # F1h 4Dh)

This parameter sets the Aztec inverse decoder setting. Options are:

- **Regular Only** - the RS6000 decodes regular Aztec bar codes only.
- **Inverse Only** - the RS6000 decodes inverse Aztec bar codes only.
- **Inverse Autodetect** - the RS6000 decodes both regular and inverse Aztec bar codes.



Han Xin

Parameter # 1167 (SSI # F8h 04h 8Fh)

To enable or disable Han Xin, scan the appropriate bar code below.



Enable Han Xin
(1)



*Disable Han Xin
(0)

Han Xin Inverse

Parameter # 1168 (SSI # F8h 04h 90h)

Select a Han Xin inverse decoder setting:

- **Regular Only** - the decoder decodes Han Xin bar codes with normal reflectance only.
- **Inverse Only** - the decoder decodes Han Xin bar codes with inverse reflectance only.
- **Inverse Autodetect** - the decoder decodes both regular and inverse Han Xin bar codes.



*Regular
(0)



Inverse Only
(1)



Inverse Autodetect
(2)

Postal Codes

US Postnet

Parameter # 89 (SSI # 59h)

To enable or disable US Postnet, scan the appropriate bar code below.



Enable US Postnet
(1)



*Disable US Postnet
(0)

US Planet

Parameter # 90 (SSI # 5Ah)

To enable or disable US Planet, scan the appropriate bar code below.



Enable US Planet
(1)



*Disable US Planet
(0)

Transmit US Postal Check Digit

Parameter # 95 (SSI # 5Fh)

Select whether to transmit US Postal data, which includes both US Postnet and US Planet, with or without the check digit.



***Transmit US Postal Check Digit
(1)**



**Do Not Transmit US Postal Check Digit
(0)**

UK Postal

Parameter # 91 (SSI # 5Bh)

To enable or disable UK Postal, scan the appropriate bar code below.



**Enable UK Postal
(1)**



***Disable UK Postal
(0)**

Transmit UK Postal Check Digit

Parameter # 96 (SSI # 60h)

Select whether to transmit UK Postal data with or without the check digit.



*Transmit UK Postal
Check Digit
(1)



Do Not Transmit UK Postal Check Digit
(0)

Japan Postal

Parameter # 290 (SSI # F0h, 22h)

To enable or disable Japan Postal, scan the appropriate bar code below.



Enable Japan Postal
(1)



*Disable Japan Postal
(0)

Australia Post

Parameter # 291 (SSI # F0h, 23h)

To enable or disable Australia Post, scan the appropriate bar code below.



Enable Australia Post
(1)



***Disable Australia Post**
(0)

Australia Post Format

Parameter # 718 (SSI # F1h, CEh)

To select one of the following formats for Australia Post, scan the appropriate bar code below:

- **Autodiscriminate** (or Smart mode) - Attempt to decode the Customer Information Field using the N and C Encoding Tables.
- ✓ **NOTE:** This option increases the risk of misdecodes because the encoded data format does not specify the Encoding Table used for encoding.
- **Raw Format** - Output raw bar patterns as a series of numbers 0 through 3.
- **Alphanumeric Encoding** - Decode the Customer Information Field using the C Encoding Table.
- **Numeric Encoding** - Decode the Customer Information Field using the N Encoding Table.

For more information on Australia Post Encoding Tables, refer to the Australia Post Customer Barcoding Technical Specifications available at auspost.com.au.

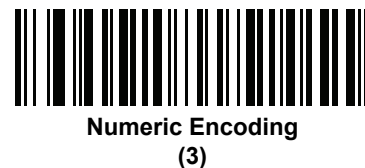
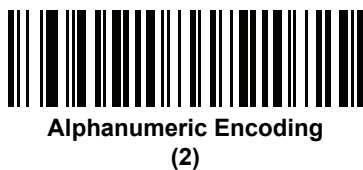

Netherlands KIX Code

Parameter # 326 (SSI # F0h, 46h)

To enable or disable Netherlands KIX Code, scan the appropriate bar code below.



Enable Netherlands KIX Code
(1)



*Disable Netherlands KIX Code
(0)

USPS 4CB/One Code/Intelligent Mail

Parameter # 592 (SSI # F1h 50h)

To enable or disable USPS 4CB/One Code/Intelligent Mail, scan the appropriate bar code below.



Enable USPS 4CB/One Code/Intelligent Mail
(1)



*Disable USPS 4CB/One Code/Intelligent Mail
(0)

UPU FICS Postal

Parameter # 611 (SSI # F1h 63h)

To enable or disable UPU FICS Postal, scan the appropriate bar code below.



Enable UPU FICS Postal
(1)



*Disable UPU FICS Postal
(0)

Mailmark

Parameter # 1337 (SSI # F8h 05h 39h)

To enable or disable Mailmark, scan the appropriate bar code below.

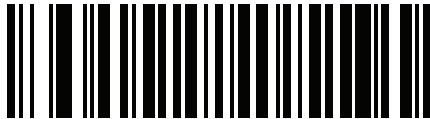

*Disable Mailmark
(0)

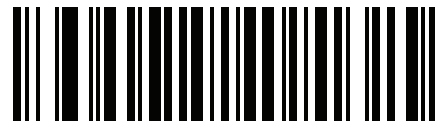

Enable Mailmark
(1)

Canada Post

Parameter # 92 (SSI # 5Ch)

To enable or disable Canada Post, scan the appropriate bar code below.

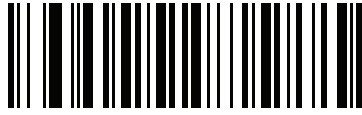

***Disable Canada Post**
(0)

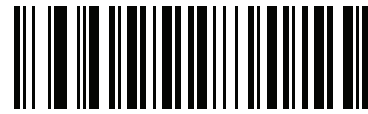

Enable Canada Post
(1)

Symbology-Specific Security Levels

Redundancy Level

Parameter # 78 (SSI # 4Eh)

The RS6000 offers four levels of decode redundancy. Select higher redundancy levels for decreasing levels of bar code quality. As redundancy levels increase, the RS6000's aggressiveness decreases.

Select the redundancy level appropriate for the bar code quality.

Redundancy Level 1

The following code types must be successfully read twice before being decoded:

Table 11 Redundancy Level 1 Codes

Code Type	Code Length
Codabar	8 characters or less
MSI	4 characters or less
D 2 of 5	8 characters or less
I 2 of 5	8 characters or less

Redundancy Level 2

The following code types must be successfully read twice before being decoded:

Table 12 Redundancy Level 2 Codes

Code Type	Code Length
All	All

Redundancy Level 3

Code types other than the following must be successfully read twice before being decoded. The following codes must be read three times:

Table 13 Redundancy Level 3 Codes

Code Type	Code Length
MSI	4 characters or less
D 2 of 5	8 characters or less
I 2 of 5	8 characters or less
Codabar	8 characters or less

Redundancy Level 4

The following code types must be successfully read three times before being decoded:

Table 14 Redundancy Level 4 Codes

Code Type	Code Length
All	All

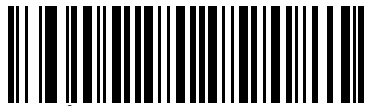

*Redundancy Level 1
(1)

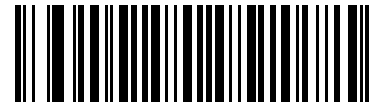

Redundancy Level 2
(2)

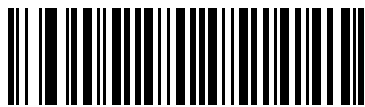

Redundancy Level 3
(3)

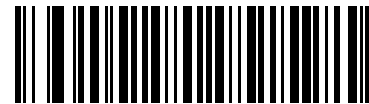

Redundancy Level 4
(4)

Security Level

Parameter # 77 (SSI # 4Dh)

The RS6000 offers four levels of decode security for delta bar codes, which include the Code 128 family, UPC/EAN, and Code 93. Select increasing levels of security for decreasing levels of bar code quality. There is an inverse relationship between security and RS6000 aggressiveness, so choose only that level of security necessary for any given application.

- **Security Level 0:** This setting allows the RS6000 to operate in its most aggressive state, while providing sufficient security in decoding most “in-spec” bar codes.
- **Security Level 1:** This default setting eliminates most misdecodes.
- **Security Level 2:** Select this option if Security level 1 fails to eliminate misdecodes.
- **Security Level 3:** If you selected Security Level 2 and misdecodes still occur, select this security level. Be advised, selecting this option is an extreme measure against mis-decoding severely out of spec bar codes. Selecting this level of security significantly impairs the decoding ability of the RS6000. If you need this level of security, try to improve the quality of the bar codes.

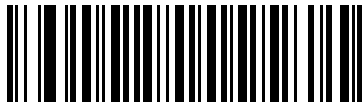

Security Level 0
(0)



*Security Level 1
(1)

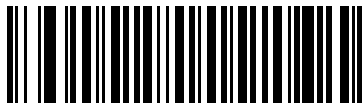

Security Level 2
(2)



Security Level 3
(3)

1D Quiet Zone Level

Parameter # 1288 (SSI # F8h 05h 08h)

This feature sets the level of aggressiveness in decoding bar codes with a reduced quiet zone (the area in front of and at the end of a bar code), and applies to symbologies enabled by a Reduced Quiet Zone parameter. Because higher levels increase the decoding time and risk of misdecodes, Symbol Technologies strongly recommends enabling only the symbologies which require higher quiet zone levels, and leaving Reduced Quiet Zone disabled for all other symbologies. Options are:

- 0 - The RS6000 performs normally in terms of quiet zone.
- 1 - The RS6000 performs more aggressively in terms of quiet zone.
- 2 - The RS6000 only requires one side EB (end of bar code) for decoding.
- 3 - The RS6000 decodes anything in terms of quiet zone or end of bar code.



1D Quiet Zone Level 0
(0)

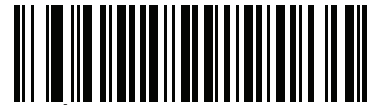

*1D Quiet Zone Level 1
(1)

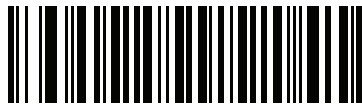

1D Quiet Zone Level 2
(2)

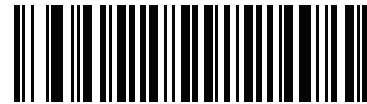

1D Quiet Zone Level 3
(3)

Intercharacter Gap Size

Parameter # 381 (SSI # F0h, 7Dh)

The Code 39 and Codabar symbologies have an intercharacter gap that is typically quite small. Due to various bar code-printing technologies, this gap can grow larger than the maximum size allowed, preventing the RS6000 from decoding the symbol. If this problem occurs, scan the **Large Intercharacter Gaps** parameter to tolerate these out-of-specification bar codes.

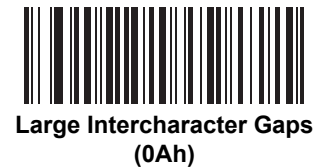

Report Version

Scan the bar code below to report the version of software installed in the RS6000.



Macro PDF Features

Macro PDF is a special feature for concatenating multiple PDF symbols into one file. The RS6000 can decode symbols that are encoded with this feature, and can store more than 64 Kb of decoded data stored in up to 50 MacroPDF symbols.



CAUTION: When printing, keep each Macro PDF sequence separate, as each sequence has unique identifiers. Do not mix bar codes from several Macro PDF sequences, even if they encode the same data. When scanning Macro PDF sequences, scan the entire Macro PDF sequence without interruption. If, when scanning a mixed sequence, the RS6000 emits two long low beeps (Low/Low) this indicates an inconsistent file ID or inconsistent symbology error.

Flush Macro Buffer

This flushes the buffer of all decoded Macro PDF data stored to that point, transmits it to the host device, and aborts from Macro PDF mode.



Flush Macro PDF Buffer

Abort Macro PDF Entry

This clears all currently-stored Macro PDF data in the buffer without transmission and aborts from Macro PDF mode.



Abort Macro PDF Entry

OCR Programming

Introduction

This chapter describes how to set up the RS6000 for OCR programming. The RS6000 can read 6 to 60 point OCR typeface. It supports font types OCR-A, OCR-B, MICR-E13B, and US Currency Serial Number.

OCR is not as secure as a bar code. To decrease OCR misdecodes and speed OCR reading, set an accurate OCR template and character subset, and use a check digit.

All OCR fonts are disabled by default. Enabling OCR can slow bar code decoding. Enabling more than one OCR font could also slow OCR decoding and impact OCR decoding accuracy.

Throughout the programming bar code menus, asterisks (*) indicate default values.

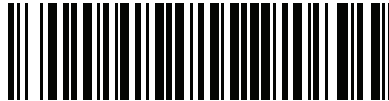

* Indicates Default * Enable Parameter Feature/Option

- ✓ **NOTE:** Most computer monitors allow scanning the bar codes directly on the screen. When scanning from the screen, be sure to set the document magnification to a level where you can see the bar code clearly, and bars and/or spaces are not merging.

[Table 15](#) lists the defaults for OCR parameters. To change any option, scan the appropriate bar code(s) provided in the Parameter Descriptions section beginning on [page 248](#).

- ✓ **NOTE:** See [Standard Default Parameters](#) for all user preferences, hosts, symbologies, and miscellaneous default parameters.

Table 15 OCR Programming Default Table

Parameter	Parameter Number	SSI Number	Default	Page Number
OCR Programming Parameters				
OCR-A	680	F1h A8h	Disable	248
OCR-A Variant	684	F1h ACh	Full ASCII	248
OCR-B	681	F1h A9h	Disable	250

Table 15 OCR Programming Default Table (Continued)

Parameter	Parameter Number	SSI Number	Default	Page Number
OCR-B Variant	685	F1h ADh	Full ASCII	251
MICR E13B	682	F1h AAh	Disable	254
US Currency	683	F1h ABh	Disable	255
OCR Orientation	687	F1h AFh	0°	255
OCR Lines	691	F1h B3h	1	257
OCR Minimum Characters	689	F1h B1h	3	257
OCR Maximum Characters	690	F1h B2h	100	258
OCR Subset	686	F1h AEh	Selected font variant	258
OCR Quiet Zone	695	F1h B7h	50	259
OCR Template	547	F1h 23h	54R	260
OCR Check Digit Modulus	688	F1h B0h	1	269
OCR Check Digit Multiplier	700	F1h BCh	121212121212	270
OCR Check Digit Validation	694	F1h B6h	None	271
Inverse OCR	856	F2h 58h	Regular	276

OCR Programming Parameters

Enable/Disable OCR-A

Parameter # 680 (SSI # F1h A8h)

To enable or disable OCR-A, scan one of the following bar codes.

- ✓ **NOTE:** OCR is not as secure as a bar code. To decrease OCR misdecodes and speed OCR reading, set an accurate OCR template and character subset, and use a check digit. See [OCR Subset on page 258](#) and [OCR Template on page 260](#).
- ✓ **NOTE:** All OCR fonts are disabled by default. Enabling OCR can slow bar code decoding. Enabling more than one OCR font could also slow OCR decoding and impact OCR decoding accuracy.



Enable OCR-A
(1)

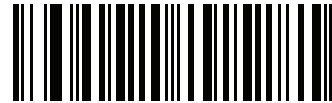

*Disable OCR-A
(0)

OCR-A Variant

Parameter # 684 (SSI # F1 ACh)

Font variant sets a processing algorithm and default character subset for the given font. To choose a variant, scan one of the following bar codes. Selecting the most appropriate font variant optimizes performance and accuracy.

OCR-A supports the following variants:

- OCR-A Full ASCII
!"#\$()*+,-./0123456789<>ABCDEFGHIJKLMNPOQRSTUVWXYZ^
- OCR-A Reserved 1
\$*+,-./0123456789ABCDEFGHIJKLMNPOQRSTUVWXYZ
- OCR-A Reserved 2
\$*+,-./0123456789<>ABCDEFGHIJKLMNPOQRSTUVWXYZ
- OCR-A Banking
-0123456789<> ¥ ¢ ¤

OCR-A Variant (continued)

Special banking characters output as the following representative characters:

Ÿ outputs as f

Ź outputs as c

Ɔ outputs as h

✓ **NOTE:** Enable OCR-A before setting this parameter. If disabling OCR-A, set the variant to its default (OCR-A Full ASCII).



*OCR-A Full ASCII
(0)

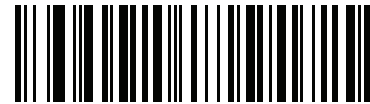

OCR-A Reserved 1
(1)



OCR-A Reserved 2
(2)



OCR-A Banking
(3)

Enable/Disable OCR-B

Parameter # 681 (SSI # F1h A9h)

To enable or disable OCR-B, scan one of the following bar codes.

- ✓ **NOTE:** OCR is not as secure as a bar code. To decrease OCR misdecodes and speed OCR reading, set an accurate OCR template and character subset, and use a check digit. See [OCR Subset on page 258](#) and [OCR Template on page 260](#).
- ✓ **NOTE:** All OCR fonts are disabled by default. Enabling OCR can slow bar code decoding. Enabling more than one OCR font could also slow OCR decoding and impact OCR decoding accuracy.



**Enable OCR-B
(1)**

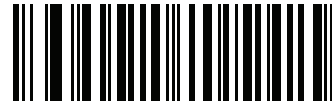

***Disable OCR-B
(0)**

OCR-B Variant

Parameter # 685 (SSI # F1h ADh)

OCR-B has the following variants. Selecting the most appropriate font variant affects performance and accuracy.

- OCR-B Full ASCII
!#\$%()*+,-./0123456789<>ABCDEFGHIJKLMNOPQRSTUVWXYZ^|ñ
- OCR-B Banking
#+-0123456789<>JNP|
- OCR-B Limited
+,-./0123456789<>ACENPSTVX
- OCR-B ISBN 10-Digit Book Numbers
-0123456789>BCEINPSXz
- OCR-B ISBN 10 or 13-Digit Book Numbers
-0123456789>BCEINPSXz
- OCR-B Travel Document Version 1 (TD1) 3-Line ID Cards
-0123456789<ABCDEFGHIJKLMNOPQRSTUVWXYZ
- OCR-B Travel Document Version 2 (TD2) 2-Line ID Cards
-0123456789<ABCDEFGHIJKLMNOPQRSTUVWXYZ
- OCR-B Travel Document 2 or 3-Line ID Cards Auto-Detect
!#\$%()*+,-./0123456789<>ABCDEFGHIJKLMNOPQRSTUVWXYZ^|ñ
- OCR-B Passport
-0123456789<ABCDEFGHIJKLMNOPQRSTUVWXYZñ
- OCR-B Visa Type A
-0123456789<ABCDEFGHIJKLMNOPQRSTUVWXYZ
- OCR-B Visa Type B
-0123456789<ABCDEFGHIJKLMNOPQRSTUVWXYZñ
- OCR-B ICAO Travel Documents
This allows reading either TD1, TD2, Passport, Visa Type A, or Visa Type B without switching between these options. It automatically recognizes the travel document read.

To choose a variant, scan one of the following bar codes. Selecting the following OCR-B variants automatically sets the appropriate [OCR Lines on page 257](#). These five variants invoke extensive special algorithms and checking for that particular document type:

Variant	OCR Lines Setting
Passport	2
TD1 ID Cards	3
TD2 ID Cards	2
Visa Type A	2
Visa Type B	2

Selecting one of the ISBN Book Numbers automatically applies the appropriate ISBN checksum, so you do not need to set this.

OCR-B Variant (continued)

For the best performance in passport reading, fix the target passport and the decoder in place (6.5 - 7.5”).

- ✓ **NOTE:** Enable OCR-B before setting this parameter. If disabling OCR-B, set the variant to its default (OCR-B Full ASCII).



*OCR-B Full ASCII
(0)

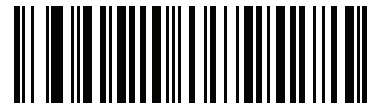

OCR-B Banking
(1)

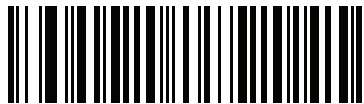

OCR-B Limited
(2)

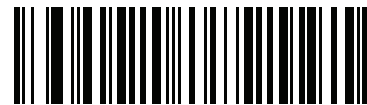

OCR-B ISBN 10-Digit Book Numbers
(6)



OCR-B ISBN 10 or 13-Digit Book Numbers
(7)



OCR-B Travel Document Version 1 (TD1)
3 Line ID Cards
(3)

OCR-B Variant (continued)



**OCR-B Travel Document Version 2 (TD2)
2-Line ID Cards
(8)**



**Travel Document 2 or 3-Line ID Cards Auto-Detect
(20)**



**OCR-B Passport
(4)**

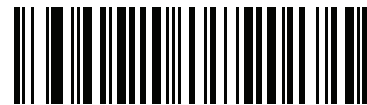

**OCR-B Visa Type A
(9)**



**OCR-B Visa Type B
(10)**



**OCR-B ICAO Travel Documents
(11)**

Enable/Disable MICR E13B

Parameter # 682 (SSI # F1h AAh)

To enable or disable MICR E13B, scan one of the following bar codes.

MICR E 13B uses the following characters:

0 1 2 3 4 5 6 7 8 9 t a o d

TOAD characters (Transit, On Us, Amount, and Dash) output as the following representative characters:

t outputs as t

a outputs as a

o outputs as o

d outputs as d

- ✓ **NOTE:** OCR is not as secure as a bar code. To decrease OCR misdecodes and speed OCR reading, set an accurate OCR template and character subset, and use a check digit. See [OCR Subset on page 258](#) and [OCR Template on page 260](#).
- ✓ **NOTE:** All OCR fonts are disabled by default. Enabling OCR can slow bar code decoding. Enabling more than one OCR font could also slow OCR decoding and impact OCR decoding accuracy.



Enable MICR E13B
(1)

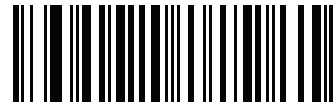

*Disable MICR E13B
(0)

Enable/Disable US Currency Serial Number

Parameter # 683 (SSI # F1h ABh)

To enable or disable US Currency Serial Number, scan one of the following bar codes.

- ✓ **NOTE:** OCR is not as secure as a bar code. To decrease OCR misdecodes and speed OCR reading, set an accurate OCR template and character subset, and use a check digit. See [OCR Subset on page 258](#) and [OCR Template on page 260](#).
- ✓ **NOTE:** All OCR fonts are disabled by default. Enabling OCR can slow bar code decoding. Enabling more than one OCR font could also slow OCR decoding and impact OCR decoding accuracy.



Enable US Currency



***Disable US Currency**

OCR Orientation

Parameter # 687 (SSI # F1h AFh)

Select one of five options to specify the orientation of an OCR string to be read:

- 0° to the imaging engine (default)
- 270° clockwise (or 90° counterclockwise) to the imaging engine
- 180° (upside down) to the imaging engine
- 90° clockwise to the imaging engine
- Omnidirectional

Setting an incorrect orientation can cause misdecodes.

OCR Orientation (continued)



***OCR Orientation 0°
(0)**



**OCR Orientation 270° Clockwise
(1)**



**OCR Orientation 180° Clockwise
(2)**



**OCR Orientation 90° Clockwise
(3)**



**OCR Orientation Omnidirectional
(4)**

OCR Lines

Parameter # 691 (SSI # F1h B3h)

To select the number of OCR lines to decode, scan one of the following bar codes. Selecting Visas, TD1, or TD2 ID cards automatically sets the appropriate **OCR Lines**. Also see [OCR-B Variant on page 251](#).



*OCR 1 Line
(1)



OCR 2 Lines
(2)



OCR 3 Lines
(3)

OCR Minimum Characters

Parameter # 689 (SSI # F1h B1h)

To select the minimum number of OCR characters (not including spaces) per line to decode, scan the following bar code, then scan a three-digit number between 003 and 100 using the bar codes in [Alphanumeric and Numeric Bar Codes](#) representing the number of OCR characters to decode. Strings of OCR characters less than the minimum are ignored. The default is 003.



OCR Minimum Characters

OCR Maximum Characters

Parameter # 690 (SSI # F1h B2h)

To select the maximum number of OCR characters (including spaces) per line to decode, scan the following bar code, then scan a three-digit number between 003 and 100 using the bar codes in [Alphanumeric and Numeric Bar Codes](#) representing the number of OCR characters to decode. Strings of OCR characters greater than the maximum are ignored. The default is 100.



OCR Maximum Characters

OCR Subset

Parameter # 686 (SSI # F1h AEh)

Set an OCR subset to define a custom group of characters in place of a preset font variant. For example, if scanning only numbers and the letters A, B, and C, create a subset of just these characters to speed decoding. This applies a designated OCR Subset across all enabled OCR fonts.

To set or modify the OCR font subset, first enable the appropriate OCR font(s). Next, scan the following bar code, then scan numbers and letters to form the OCR Subset from the alphanumeric keyboard in the *Advanced Data Formatting Guide*. Then scan **End of Message** in the *Advanced Data Formatting Guide*.

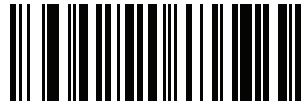

OCR Subset

To cancel an OCR subset, for OCR-A or OCR-B, scan OCR-A variant **Full ASCII**, or OCR-B variant **Full ASCII**.

For MICR E13B or US Currency Serial Number, create a subset which includes all allowed characters in that character set, or scan an option from the [Default Parameters on page 116](#) and re-program the RS6000.

OCR Quiet Zone

Parameter # 695 (SSI # F1h B7h)

This option sets the OCR quiet zone. The RS6000 stops scanning a field when it detects a sufficiently wide blank space. The width of this space is defined by the End of Field option. Used with parsers that tolerate slanted characters, the End of Field count is roughly a count of 8 for a character width. For example if set to 15, then two character widths are an end of line indicator for the parser. Larger end of field numbers require bigger quiet zones at each end of text line.

To set a quiet zone, scan the following bar code, then scan a two-digit number using the numeric keypad in the Advanced Data Formatting Guide. The range of the quiet zone is 20 - 99 and the default is 50, indicating a six character width quiet zone.



OCR Quiet Zone

OCR Template

Parameter # 547 (SSI # F1h 23h)

This option creates a template for precisely matching scanned OCR characters to a desired input format. Carefully constructing an OCR template eliminates scanning errors.

To set or modify the OCR decode template, scan the [OCR Template](#) bar code, then bar codes corresponding to numbers and letters on the following pages to form the template expression. Then scan **End of Message** in the Advanced Data Formatting Guide. The default is **54R** which accepts any character OCR strings.

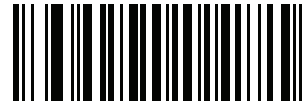

OCR Template



End of Message

Required Digit (9)



9

Only a numeric character is allowed in this position.

Template	Valid data	Valid data	Invalid data
99999	12987	30517	123AB

Required Alpha (A)



A

Only an alpha character is allowed in this position.

Template	Valid data	Valid data	Invalid data
AAA	ABC	WXY	12F

Require and Suppress (0)

It is required that any character in this position, including space or reject, is suppressed from the output.

Template	Incoming data	Output
990AA	12QAB	12AB

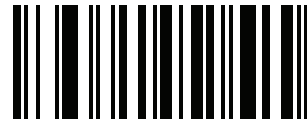

0

Optional Alphanumeric (1)



1

When this option appears in the template string, the data validator accepts an alphanumeric character if present. Optional characters are not allowed as the first character(s) in a field of like characters.

Template	Valid data	Valid data	Invalid data
99991	1234A	12345	1234<

Optional Alpha (2)



2

When this option appears in the template string, the data validator accepts an alpha character if present. Optional characters are not allowed as the first character(s) in a field of like characters.

Template	Valid data	Valid data	Invalid data
AAAA2	ABCDE	WXYZ	ABCD6

Alpha or Digit (3)

3

The data validator requires an alphanumeric character in this position to validate the incoming data.

Template	Valid data	Valid data	Invalid data
33333	12ABC	WXY34	12AB<

Any Including Space & Reject (4)

4

The template accepts any character in this position, including space and reject. Rejects are represented as an underscore (_) in the output. This is a good selection for troubleshooting.

Template	Valid data	Valid data
99499	12\$34	34_98

Any except Space & Reject (5)

5

The template accepts any character in this position except a space or reject.

Template	Valid data	Valid data	Invalid data
55999	A.123	*Z456	A BCD

Optional Digit (7)

7

When this option appears in the template string, the template accepts a numeric character if present. Optional characters are not allowed as the first character(s) in a field of like characters.

Template	Valid data	Valid data	Invalid data
99977	12345	789	789AB

Digit or Fill (8)

8

The data validator accepts any numeric or fill character in this position.

Template	Valid data	Valid data	Valid data
88899	12345	>>789	<<789

Alpha or Fill (F)

F

The data validator accepts any alpha or fill character in this position.

Template	Valid data	Valid data	Valid data
AAAF	ABCXY	LMN>>	ABC<5

Optional Space ()



Space

When this option appears in the template string, the template accepts a space if present. Optional characters are not allowed as the first character(s) in a field of like characters.

Template	Valid data	Valid data	Invalid data
99 99	12 34	1234	67891

Optional Small Special (.)



.

When this option appears in the template string, the data validator accepts a special character if present. Optional characters are not allowed as the first character(s) in a field of like characters. Small special characters are - , and .

Template	Valid data	Valid data	Invalid data
AA.99	MN.35	XY98	XYZ12

Other Template Operators

These template operators assist in capturing, delimiting, and formatting scanned OCR data.

Literal String (" and +)



“



+

Use either of these delimiting characters surrounding characters from the alphanumeric keyboard in the *Advanced Data Formatting Guide* to define a literal string within a template that must be present in scanned OCR data. There

are two characters used to delimit required literal strings; if one of the delimiter characters is present in the desired literal string, use the other delimiter.

Template	Valid data	Invalid data
"35+BC"	35+BC	AB+22

New Line (E)



E

To create a template of multiple lines, add **E** between the template of each single line.

Template	Valid data	Valid data	Invalid data
999EAAAA	321	987	XYZW
	BCAD	ZXYW	12

String Extract (C)



C

This operator combined with others defines a string of characters to extract from the scanned data. The string extract is structured as follows:

CbPe

Where:

- **C** is the string extract operator
- **b** is the string begin delimiter
- **P** is the category (one or more numeric or alpha characters) describing the string representation
- **e** is the string end delimiter

Values for **b** and **e** can be any scannable character. They are included in the output stream.

Template	Incoming data	Output
C>A>	XQ3>ABCDE>	>ABCDE>
	->ATHRUZ>123	>ATHRUZ>
	1ABCZXYZ	No Output

Ignore to End of Field (D)**D**

This operator causes all characters after a template to be ignored. Use this as the last character in a template expression. Examples for the template 999D:

Template	Incoming data	Output
999D	123-PED	123
	357298	357
	193	193

Skip Until (P1)**P****1**

This operator allows skipping over characters until a specific character type or a literal string is detected. It can be used in two ways:

```
P1ct
```

Where:

- P1 is the Skip Until operator
- c is the type of character that triggers the start of output
- t is one or more template characters

```
P1"s"t
```

Where:

- P1 is the Skip Until operator
- "s" is one or more literal string characters (see [Literal String \(" and +\) on page 264](#)) that trigger the start of output
- t is one or more template characters

The trigger character or literal string is included in output from a Skip Until operator, and the first character in the template should accommodate this trigger.

Template	Incoming data	Output
P1"PN"AA9999	123PN9876	PN9876
	PN1234	PN1234
	X-PN3592	PN3592

Skip Until Not (P0)



P



0

This operator allows skipping over characters until a specific character type or a literal string is not matched in the output stream. It can be used in two ways:

`P0ct`

Where:

- P0 is the Skip Until Not operator
- c is the type of character that triggers the start of output
- t is one or more template characters

`P0"s"t`

Where:

- P0 is the Skip Until Not operator
- "s" is one or more literal string characters (see [Literal String \(" and +\) on page 264](#)) that trigger the start of output
- t is one or more template characters

The trigger character or literal string is not included in output from a Skip Until Not operator.

Template	Incoming data	Output
P0A9999	BN3456	3456
	PN1234	1234
	5341	No output

Template	Incoming data	Output
P0"PN"9999	PN3456	3456
	5341	No output
	PNPN7654	7654

Repeat Previous (R)



R

This operator allows a template character to repeat one or more times, allowing the capture of variable-length scanned data. The following examples capture two required alpha characters followed by one or more required digits:

Template	Incoming data	Output
AA9R	AB3	AB3
	PN12345	PN12345
	32RM52700	No output

Scroll Until Match (S)



S

This operator steps through scanned data one character at a time until the data matches the template.

Template	Incoming data	Output
S99999	AB3	No Output
	PN12345	12345
	32RM52700	52700

Multiple Templates

This feature sets up multiple templates for OCR decoding. To do this, follow the procedure described in [OCR Template on page 260](#) (scan the [OCR Template](#) bar code, then bar codes corresponding to numbers and letters to

form the template expression, then **End of Message**) for each template in the multiple template string, using a capital letter **X** as a separator between the templates.

For example, set the [OCR Template](#) as **99999XAAAAA** to decode OCR strings of either **12345** or **ABCDE**.

Template Examples

Following are sample templates with descriptions of valid data for each definition.

Field Definition Description

"M"99977	M followed by three digits and two optional digits.
"X"997777"X"	X followed by two digits, four optional digits, and an X.
9959775599	Two digits followed by any character, a digit, two optional digits, any two characters, and two digits.
A55"- "999"- "99	A letter followed by two characters, a dash, three digits, a dash, and two digits.
33A" . "99	Two alphanumeric characters followed by a letter, a period, and two digits.
999992991	Five digits followed by an optional alpha, two digits, and an optional alphanumeric.
"PN98"	Literal field - PN98

OCR Check Digit Modulus

Parameter # 688 (SSI # F1h B0h)

This option sets OCR module check digit calculation. The check digit is the last digit (in the right most position) in an OCR string and improves the accuracy of the collected data. The check digit is the end product of a calculation made on the incoming data. For check digit calculation, for example Modulus 10, alpha and numeric characters are assigned numeric weights (see [OCR Check Digit Multiplier on page 270](#)). The calculation is applied to the character weights and the resulting check digit is added to the end of the data. If the incoming data does not match the check digit, the data is considered corrupt.

The selected check digit option does not take effect until you set **OCR Check Digit Validation**.

To choose the Check Digit Modulus, such as 10 for modulo 10, scan the following bar code, then scan a three-digit number from 001 to 099 representing the check digit using the numeric keypad in the Advanced Data Formatting Guide. The default is 1.



OCR Check Digit

OCR Check Digit Multiplier

Parameter # 700 (SSI # F1h BCh)

This option sets OCR check digit multipliers for the character positions. For check digit validation, each character in scanned data has an equivalent weight used in the check digit calculation. RS6000 OCR ships with the following weight equivalents:

0 = 0	A = 10	K = 20	U = 30
1 = 1	B = 11	L = 21	V = 31
2 = 2	C = 12	M = 22	W = 32
3 = 3	D = 13	N = 23	X = 33
4 = 4	E = 14	O = 24	Y = 34
5 = 5	F = 15	P = 25	Z = 35
6 = 6	G = 16	Q = 26	Space = 0
7 = 7	H = 17	R = 27	
8 = 8	I = 18	S = 28	
9 = 9	J = 19	T = 29	

All other characters are equivalent to one (1).

You can define the multiplier string if it is different from the default.

121212121212 (default)

123456789A (for ISBN, Product Add Right to Left. See [OCR Check Digit Validation on page 271](#))

For example:

ISBN	0	2	0	1	1	8	3	9	9	4
Multiplier	10	9	8	7	6	5	4	3	2	1
Product	0	18	0	7	6	40	12	27	18	4
Product add	0+	18+	0+	7+	6+	40+	12+	27+	18+	4= 132

ISBN uses modulo 11 for its check digit. In this case, 132 is divisible by 11, so it passes the check digit.

To set the check digit multiplier, scan the following bar code, then scan numbers and letters to form the multiplier string from the alphanumeric keyboard in the Advanced Data Formatting Guide. Then scan **End of Message** in the Advanced Data Formatting Guide.



OCR Check Digit Multiplier

OCR Check Digit Validation

Parameter # 694 (SSI # F1h B6h)

Use **OCR Check Digit Validation** to protect against scanning errors by applying a check digit validation scheme. The following is a list of options.

None

No check digit validation, indicating no check digit is applied. This is the default.



***No Check Digit
(0)**

Product Add Left to Right

Each character in the scanned data is assigned a numeric value (see [OCR Check Digit Multiplier on page 270](#)). Each digit representing a character in the scanned data is multiplied by its corresponding digit in the multiplier, and the sum of these products is computed. The check digit passes if this sum modulo Check Digit Modulus is zero.

Example:

Scanned data numeric value is 132456 (check digit is 6)

Check digit multiplier string is 123456

Digit	1	3	2	4	5	6	
Multiplier	1	2	3	4	5	6	
Product	1	6	6	16	25	36	
Product add	1+	6+	6+	16+	25+	36=	90

The Check Digit Modulus is 10. It passes because 90 is divisible by 10 (the remainder is zero).



**Product Add Left to Right
(3)**

Product Add Right to Left

Each character in the scanned data is assigned a numeric value (see [OCR Check Digit Multiplier on page 270](#)). The check digit multiplier is reversed in order. Each value representing a character in the scanned data is multiplied by its corresponding digit in the reversed multiplier, resulting in a product for each character in the scanned data. The sum of these products is computed. The check digit passes if this sum modulo Check Digit Modulus is zero.

Example:

Scanned data numeric value is 132459 (check digit is 9)

Check digit multiplier string is 123456

Digit	1	3	2	4	5	9	
Multiplier	6	5	4	3	2	1	
Product	6	15	8	12	10	9	
Product add	6+	15+	8+	12+	10+	9=	60

The Check Digit Modulus is 10. It passes because 60 is divisible by 10 (the remainder is 0).



**Product Add Right to Left
(1)**

Digit Add Left to Right

Each character in the scanned data is assigned a numeric value (see [OCR Check Digit Multiplier on page 270](#)). Each value representing a character in the scanned data is multiplied by its corresponding digit in the multiplier, resulting in a product for each character in the scanned data. The sum of each individual digit in all of the products is then calculated. The check digit passes if this sum modulo Check Digit Modulus is zero.

Example:

Scanned data numeric value is 132456 (check digit is 6)

Check digit multiplier string is 123456

Digit	1	3	2	4	5	6	
Multiplier	1	2	3	4	5	6	
Product	1	6	6	16	25	36	
Digit add	1+	6+	6+	1+6+	2+5+	3+6=	36

The Check Digit Modulus is 12. It passes because 36 is divisible by 12 (the remainder is 0).



**Digit Add Left to Right
(4)**

Digit Add Right to Left

Each character in the scanned data is assigned a numeric value (see [OCR Check Digit Multiplier on page 270](#)). The check digit multiplier is reversed in order. Each value representing a character in the scanned data is multiplied by its corresponding digit in the reversed multiplier, resulting in a product for each character in the scanned data. The sum of each individual digit in all of the products is then calculated. The check digit passes if this sum modulo Check Digit Modulus is zero.

Example:

Scanned data numeric value is 132456 (check digit is 6)

Check digit multiplier string is 123456

Digit	1	3	2	4	5	6	
Multiplier	6	5	4	3	2	1	
Product	6	15	8	12	10	6	
Digit add	6+	1+5+	8+	1+2+	1+0+	6=	30

The Check Digit Modulus is 10. It passes because 30 is divisible by 10 (the remainder is 0).



**Digit Add Right to Left
(2)**

Product Add Right to Left Simple Remainder

Each character in the scanned data is assigned a numeric value (see [OCR Check Digit Multiplier on page 270](#)). The check digit multiplier is reversed in order. Each value representing a character in the scanned data is multiplied by its corresponding digit in the reversed multiplier, resulting in a product for each character in the scanned data. The sum of these products **except for the check digit's product** is computed. The check digit passes if this sum modulo Check Digit Modulus is equal to the check digit's product.

Example:

Scanned data numeric value is 122456 (check digit is 6)

Check digit multiplier string is 123456

Digit	1	2	2	4	5	6
Multiplier	6	5	4	3	2	1

Product	6	10	8	12	10		6
Product add	6+	10+	8+	12+	10=	46	6

The Check Digit Modulus is 10. It passes because 46 divided by 10 leaves a remainder of 6.



**Product Add Right to Left Simple Remainder
(5)**

Digit Add Right To Left Simple Remainder

Each character in the scanned data is assigned a numeric value (see [OCR Check Digit Multiplier on page 270](#)). The check digit multiplier is reversed in order. Each value representing a character in the scanned data is multiplied by its corresponding digit in the reversed multiplier, resulting in a product for each character in the scanned data. The sum of each individual digit in all of the products **except for the check digit's product** is then calculated. The check digit passes if this sum modulo Check Digit Modulus is equal to the check digit's product.

Example:

Scanned data numeric value is 122459 (check digit is 6)

Check digit multiplier string is 123456

Digit	1	2	2	4	5		9
Multiplier	6	5	4	3	2		1
Product	6	10	8	12	10		9
Digit add	6+	1+0+	8+	1+2+	1+0=	19	9

The Check Digit Modulus is 10. It passes because 19 divided by 10 leaves a remainder of 9.



**Digit Add Right to Left Simple Remainder
(6)**

Health Industry - HIBCC43

This is the health industry module 43 check digit standard. The check digit is the modulus 43 sum of all the character values in a given message, and is printed as the last character in a given message.

Example:

Supplier Labelling Data Structure: + A 1 2 3 B J C 5 D 6 E 7 1

Sum of values: $41+10+1+2+3+11+19+12+5+13+6+14+7+1 = 145$

Divide 145 by 43. The quotient is 3 with a remainder of 16. The check digit is the character corresponding to the value of the remainder (see [Table 16](#)), which in this example is 16, or **G**. The complete Supplier Labeling Data Structure, including the check digit, therefore is:

A 1 2 3 B J C 5 D 6 E 7 1 G

Table 16 Table of Numeric Value Assignments for Computing HIBC LIC Data Format Check Digit

0 = 0	9 = 9	I = 18	R = 27	- = 36
1 = 1	A = 10	J = 19	S = 28	. = 37
2 = 2	B = 11	K = 20	T = 29	Space = 38
3 = 3	C = 12	L = 21	U = 30	\$ = 39
4 = 4	D = 13	M = 22	V = 31	/ = 40
5 = 5	E = 14	N = 23	W = 32	+ = 41
6 = 6	F = 15	O = 24	X = 33	% = 42
7 = 7	G = 16	P = 25	Y = 34	
8 = 8	H = 17	Q = 26	Z = 35	



**Health Industry - HIBCC43
(9)**

Inverse OCR

Parameter # 856 (SSI # F2h 58h)

Inverse OCR is white or light words on a black or dark background. Select an option for decoding inverse OCR:

- **Regular Only** - decode regular OCR (black on white) strings only.
- **Inverse Only** - decode inverse OCR (white on black) strings only.
- **Autodiscriminate** - decodes both regular and inverse OCR strings.

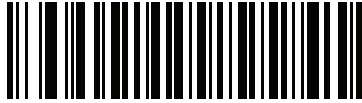

***Regular Only**
(0)

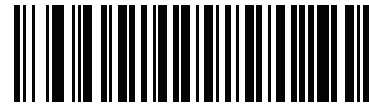

Inverse Only
(1)



Autodiscriminate
(2)

123Scan and Software Tools

Introduction

This chapter briefly describes the Zebra software tools available for customizing scanner operation.

123Scan

123Scan is a software tool that simplifies scanner setup and more.

Intuitive enough for first time users, the 123Scan wizard guides users through a streamlined setup process. Settings are saved in a configuration file that can be printed as a single programming barcode for scanning, emailed to a smart phone for scanning from its screen, or downloaded to the scanner using a USB charging cradle.

Through 123Scan a user can:

- Configure a scanner using a wizard.
 - Program the following scanner settings.
 - Beeper tone / volume settings.
 - Enable / disable symbologies.
 - Communication settings.
 - Modify data before transmission to a host using:
 - Advanced Data Formatting (ADF) - Scan one barcode per trigger pull.
 - Multicode Data Formatting (MDF) - Scan many barcodes in one trigger pull (select scanners).
 - Preferred Symbol - Single out one barcode on label of many (select scanners).
- Load parameter settings to a scanner via the following.
 - Barcode scanning.
 - Scan a paper barcode.
 - Scan a barcode from a PC screen.
 - Scan a barcode from a smart phone screen.
 - Download over a USB cable.
 - Load settings to one scanner.
 - Stage up to 10 scanners simultaneously (Powered USB Hub recommended with 0.5 amp / port).

- Validate scanner setup.
 - Review settings using the Parameter Report.
 - Clone settings from an already deployed scanner from the **Start** screen.
- Upgrade scanner firmware.
 - Load settings to one scanner.
 - Stage up to 10 scanners simultaneously (Powered USB Hub recommended with 0.5 amp / port).
- View statistics such as:
 - Asset tracking information.
 - Time and usage information.
 - Barcodes scanned by symbology.
 - Battery diagnostics (select scanners).
- Generate the following reports.
 - Barcode Report - Programming barcode, included parameter settings, and supported scanner models.
 - Parameter Report - Parameters programmed within a configuration file.
 - Inventory Report - Scanner asset tracking information.
 - Statistics Report - All statistics retrieved from the scanner.

For more information go to: zebra.com/123Scan.

Communication with 123Scan

Use a USB charging cradle to connect the RS6000 to a Windows host computer running 123Scan.

123Scan Requirements

- Host computer running Windows XP, 7, 8, and 10
- Scanner
- USB cable.

123Scan Information

For more information on 123Scan, go to: zebra.com/123Scan

For a 1 minute tour of 123Scan, go to: zebra.com/ScannerHowToVideos

To see a list of all of our software tools, go to: zebra.com/scannersoftware

Scanner Control App (SCA)

The Scanner Control App (SCA) allows you to control the RS6000 from a non-Zebra device, such as a phone or tablet. Use this app to showcase a Zebra Bluetooth scanner's capabilities and ease of control right from your phone.

The Scanner Control App supports Scan-To-Connect technology for one-step Bluetooth pairing, and allows you to control the following scanner functions:

- Program the beeper and LEDs.
- Enable and disable symbologies.
- Remotely trigger a scan.

The app displays scanned barcode data, and can query scanner asset information and battery health statistics.

The Scanner Control App is available on the Android Play, iOS App, and Zebra AppGallery stores. Source code is available within the Zebra Scanner SDK for Android and iOS.

To watch a 1 minute tour of the Scanner Control App, go to: zebra.com/scannercontrolapp.

Advanced Data Formatting (ADF)

Advanced Data Formatting (ADF) allows customizing data before transmission to the host device. Use ADF to edit scanned data to suit the host application's requirements. With ADF you scan one barcode per trigger pull. ADF is programmed using 123Scan.

For a video on Creating an Advanced Data Formatting (ADF) Rule using 123Scan, go to: zebra.com/ScannerHowToVideos.

For additional information, refer to the Advanced Data Formatting Programmer Guide.

Multicode Data Formatting (MDF)

Multicode Data Formatting (MDF) enables a 2D imaging scanner to scan all barcodes on a label with a single trigger pull, and then modify and transmit the data to meet host application requirements. MDF supports programming up to nine unique labels into one scanner. MDF also supports scanning multiple barcodes on opposite sides of a box by holding the trigger.

Programming options include:

- Output all or specific barcodes.
- Control the barcode output sequence.
- Apply unique multicode data formatting (MDF) to each output barcode.
- Discard scanned data if all required barcodes are not present.

For more information, refer to the Multicode Data Formatting and Preferred Symbol User Guide, p/n MN-002895-xx.

For a video on Creating an Multicode Data Formatting (MDF) Rule using 123Scan, go to: zebra.com/ScannerHowToVideos.

Preferred Symbol

Preferred Symbol is a barcode prioritization technique that enables favored decoding of high priority barcode(s). The Preferred Symbol is the only barcode that is decoded and output within the preset Preferred Symbol Timeout. During this time, the scanner attempts to decode the prioritized barcode and reports only this barcode.

For more information, refer to the Multicode Data Formatting and Preferred Symbol User Guide, p/n MN-002895-xx.

To program Preferred Symbol via 123Scan, select 123Scan > Configuration Wizard > Symbologies screen, and then select Preferred Symbol from the drop-down menu. Preferred Symbol programming is saved in the 123Scan configuration file.

Maintenance and Troubleshooting

Introduction

This chapter provides suggested RS6000 troubleshooting and maintenance.

Maintenance

Cleaning the scan window is the basic maintenance required. A dirty window can affect scanning performance.

- Do not allow abrasive material to touch the window.
- Remove any dirt particles with a damp cloth.
- Wipe the window using a tissue moistened with ammonia/water.
- Do not spray water or other cleaning liquids directly into the window.

Battery Safety Guidelines

- The area in which the RS6000 units are charged should be clear of debris and combustible materials or chemicals. Particular care should be taken where the device is charged in a non-commercial environment.
- Do not use incompatible batteries and chargers. If you have any questions about the compatibility of a battery or a charger, contact Zebra Support. See [Service Information on page 16](#) for contact information.
- Do not crush, puncture, or place a high degree of pressure on the battery.
- Follow battery usage, storage, and charging guidelines.
- Improper battery use may result in a fire, explosion, or other hazard.
- To charge the mobile device battery, the battery and charger temperatures must be between +32°F and +104°F (0°C and +40°C)
- Do not disassemble or open, crush, bend or deform, puncture, or shred.
- Severe impact from dropping any battery-operated device on a hard surface could cause the battery to overheat.
- Do not short circuit a battery or allow metallic or conductive objects to contact the battery terminals.
- Do not modify or remanufacture, attempt to insert foreign objects into the battery, immerse or expose to water or other liquids, or expose to fire, explosion, or other hazard.
- Do not leave or store the equipment in or near areas that might get very hot, such as in a parked vehicle or near a radiator or other heat source. Do not place battery into a microwave oven or dryer.

- Battery usage by children should be supervised.
- Please follow local regulations to promptly dispose of used re-chargeable batteries.
- Do not dispose of batteries in fire.
- Seek medical advice immediately if a battery has been swallowed.
- In the event of a battery leak, do not allow the liquid to come in contact with the skin or eyes. If contact has been made, wash the affected area with large amounts of water and seek medical advice.
- If you suspect damage to your equipment or battery, call Customer Support to arrange for inspection. See [Service Information on page 16](#) for contact information.

Long Term Storage

When storing the RS6000 for a long period of time, it is recommended to remove the battery. When returning the RS6000 to everyday operation, install a fully charged battery.

Cleaning Instructions



CAUTION: Always wear eye protection.

Read warning label on compressed air and alcohol product before using.

If you have to use any other solution for medical reasons please contact Zebra for more information.



WARNING: Avoid exposing this product to contact with hot oil or other flammable liquids. If such exposure occurs, unplug the device and clean the product immediately in accordance with these guidelines.

Approved Cleanser Active Ingredients

100% of the active ingredients in any cleaner must consist of one or some combination of the following: isopropyl alcohol, or mild dish soap.

Harmful Ingredients

The following chemicals are known to damage the plastics on the device and should not come in contact with the device: ammonia solutions, compounds of amines or ammonia; acetone; ketones; ethers; aromatic and chlorinated hydrocarbons; aqueous or alcoholic alkaline solutions; ethanolamine; toluene; trichloroethylene; benzene; carbolic acid, TB-lysoform, bleach products and hydrogen peroxide.

Cleaning Instructions

Do not apply liquid directly to the device. Dampen a soft cloth or use pre-moistened wipes. Do not wrap the device in the cloth or wipe, but gently wipe the unit. Be careful not to let liquid pool around the display window or other places. Allow the unit to air dry before use.

Special Cleaning Notes

Many vinyl gloves contain phthalate additives, which are often not recommended for medical use and are known to be harmful to the housing of the device. The device should not be handled while wearing vinyl gloves containing phthalates, or before hands are washed to remove contaminant residue after gloves are removed. If products

containing any of the harmful ingredients listed above are used prior to handling the device, such as hand sanitizer that contain ethanalamine, hands must be completely dry before handling the device to prevent damage to the plastics.

Cleaning Materials Required

- Alcohol wipes
- Lens tissue
- Cotton tipped applicators
- Isopropyl alcohol
- Can of compressed air with a tube.

Cleaning Frequency

The cleaning frequency is up to the customer's discretion due to the varied environments in which the WT6000 units are used. They may be cleaned as frequently as required. However when used in dirty environments it may be advisable to periodically clean the scanner exit window to ensure optimum scanning performance.

Cleaning the RS6000

Housing

Using alcohol wipes, wipe the housing.

Exit Window

Wipe the exit window periodically with a lens tissue or other material suitable for cleaning eyeglasses.



CAUTION: Do not pour, spray, or spill any liquid on the RS6000.

Power Connector

1. Remove the battery from RS6000.
2. Dip the cotton portion of the cotton tipped applicator in isopropyl alcohol.
3. Rub the cotton portion of the cotton tipped applicator back-and-forth across the battery connector inside the battery compartment and the I/O connector on the top side of the RS6000. Do not leave any cotton residue on the connectors.
4. Repeat at least three times.
5. Use the cotton tipped applicator dipped in alcohol to remove any grease and dirt near the connector area.
6. Use a dry cotton tipped applicator and repeat steps 3 through 5.
7. Spray compressed air on the connector area by pointing the tube/nozzle about ½ inch away from the surface.



CAUTION: Do not point nozzle at yourself and others, ensure the nozzle or tube is away from your face.

8. Inspect the area for any grease or dirt, repeat if required.

Cleaning Cradle Connectors

Use this procedure to clean the connectors on a cradle:

1. Remove power from the cradle.
2. Dip the cotton portion of the cotton tipped applicator in isopropyl alcohol.
3. Rub the cotton portion of the cotton tipped applicator along the pins of the connector. Slowly move the applicator back-and-forth from one side of the connector to the other. Do not let any cotton residue on the connector.
4. All sides of the connector should also be rubbed with the cotton tipped applicator.
5. Spray compressed air in the connector area by pointing the tube/nozzle about ½ inch away from the surface.



CAUTION: Do not pour, spray, or spill any liquid on the RS6000.

6. Ensure that there is no lint left by the cotton tipped applicator, remove lint if found.
7. If grease and other dirt can be found on other areas of the cradle, use lint free cloth and alcohol to remove.
8. Allow at least 10 to 30 minutes (depending on ambient temperature and humidity) for the alcohol to air dry before applying power to cradle.

If the temperature is low and humidity is high, longer drying time is required. Warm temperature and dry humidity requires less drying time.

Cleaning the Comfort Pads

It may be necessary to wash the wrist mount strap and replaceable comfort pad when they become soiled.

Figure 57 RS6000 Comfort Pads and Strap

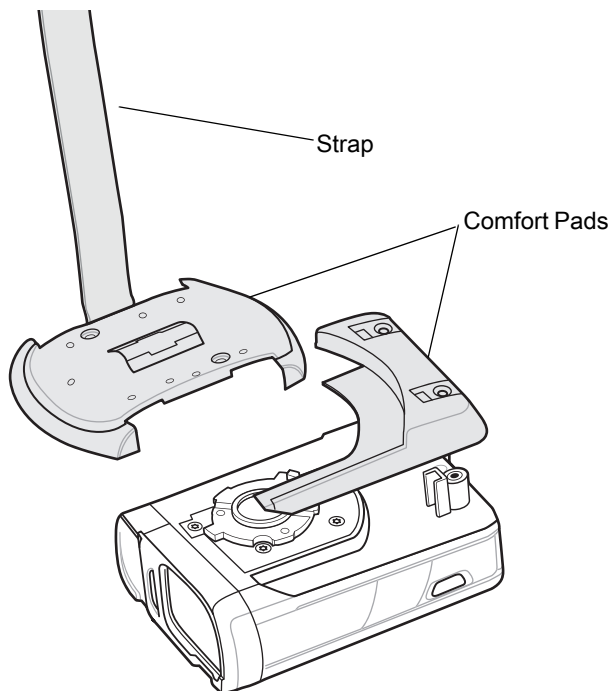

Remove the strap and comfort pads. See [Comfort Pad Replacement on page 285](#). Hand wash in cold water with dish soap. Do not use bleach. Air dry. Do not use a hand dryer. Leave the comfort pad to air dry in a shaded area.

Comfort Pad Replacement

The RS6000 includes two comfort pads. The large comfort pad must be removed first, then the small comfort pad can be removed.

Large Comfort Pad Removal

To remove the Large Comfort Pad:

1. Remove the comfort pad screws with a T6 Torx screwdriver.
2. Remove the Large Comfort Pad from the RS6000.

Figure 58 Removal of Large Comfort Pad

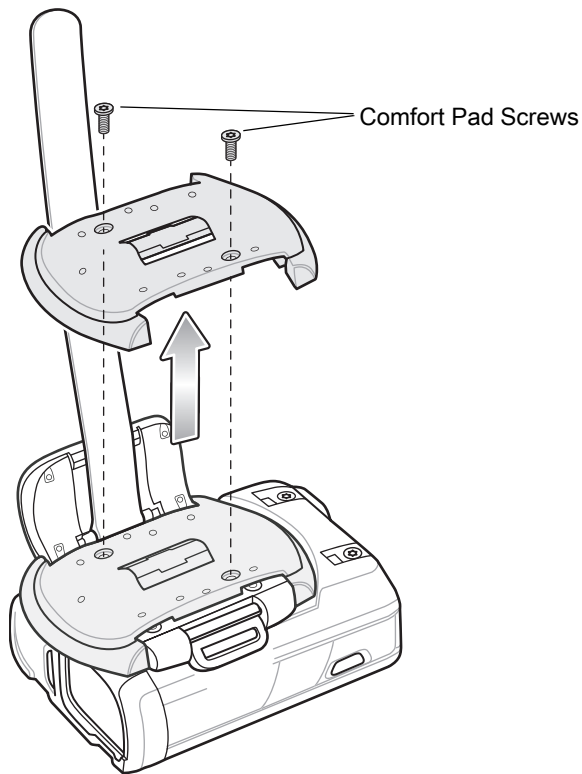

Small Comfort Pad Removal

To remove the Small Comfort Pad:

Figure 59 Removal of Small Comfort Pad

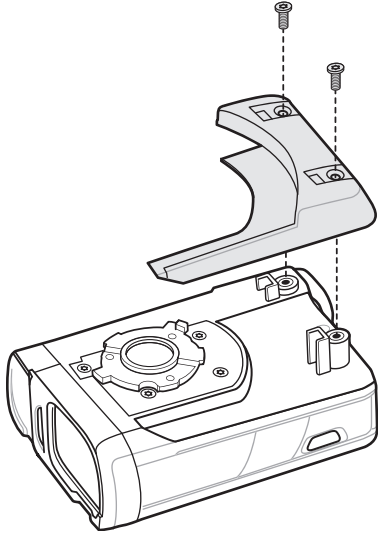

1. Remove the Large Comfort Pad. See [Large Comfort Pad Removal on page 285](#).
2. Remove the Trigger Assembly. See [Trigger Assembly Removal on page 288](#)
3. Remove small comfort pad screws using a T6 Torx screwdriver.
4. Lift Small Comfort Pad out of the RS6000.

Small Comfort Pad Installation

To install the Small Comfort Pad:

1. Place Small Comfort Pad on to the RS6000
2. Install small comfort pad screws using a T6 Torx screwdriver. Torque screws to 2 kgf-cm.
3. Install the Trigger Assembly. See [Trigger Assembly Installation on page 288](#)
4. Install the Large Comfort Pad. See [Large Comfort Pad Installation on page 287](#).

Large Comfort Pad Installation

To install the Comfort Pad:

1. Position the Comfort Pad onto the RS6000 as shown.

Figure 60 Installation of Comfort Pad

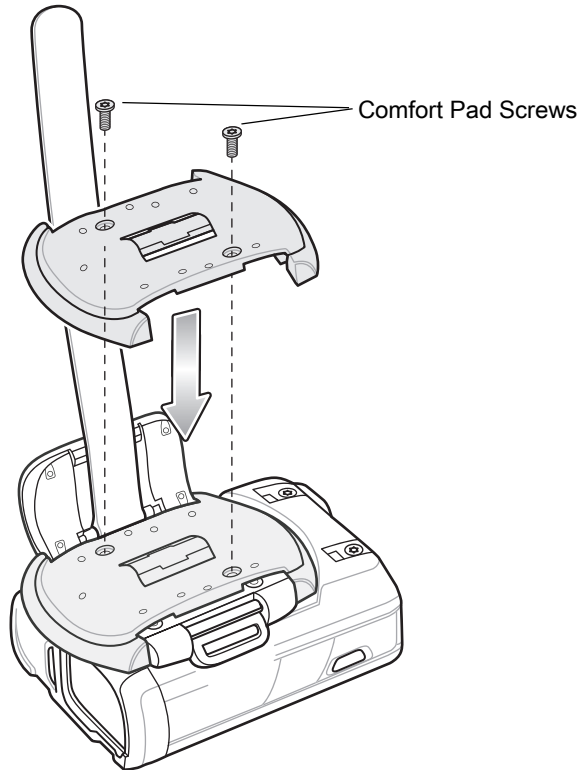

2. Press the Comfort Pad onto the RS6000. When properly installed, the Comfort Pad locks into place.
3. Install comfort pad screws with a T6 Torx screwdriver. Torque screw to 2 kgf-cm.

Trigger Assembly Replacement

Trigger Assembly Removal

To remove the Trigger Assembly:

1. Turn the RS6000 upside-down.
2. Remove the Large Comfort Pad. See [Large Comfort Pad Removal on page 285](#).
3. Remove locking screw using a T6 Torx screwdriver.

Figure 61 Removal of Trigger Assembly

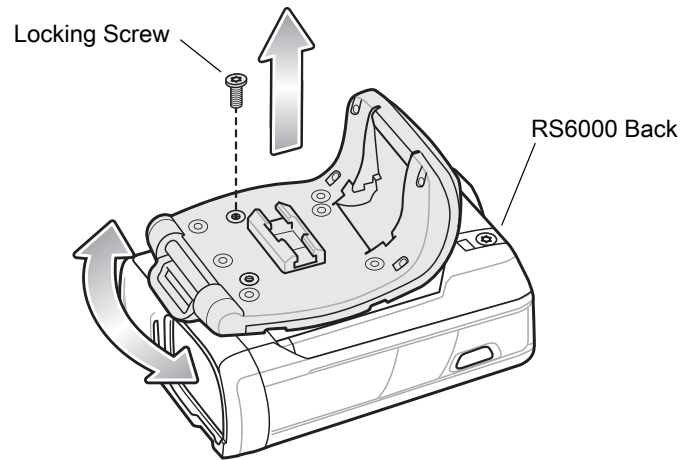

4. Rotate the Trigger Assembly to align with the back of the RS6000.
5. Lift the Trigger Assembly off the housing.

Trigger Assembly Installation

To install the Trigger Assembly:

1. Turn the RS6000 upside-down.
2. Position the Trigger Assembly to align with the back of the RS6000.
3. Lower the Trigger Assembly onto the housing.

Figure 62 Installation of Trigger Assembly

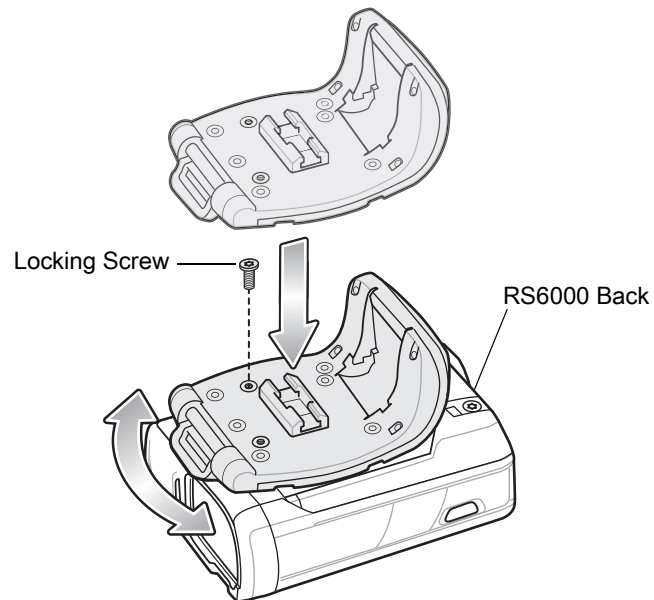

4. Replace locking screw using a T6 Torx screwdriver. Torque screw to 2 kgf-cm.
5. Rotate the Trigger Assembly 1/4 turn counterclockwise.
6. Press the Large Comfort Pad onto the RS6000. When properly installed, the comfort pad locks into place.
7. Replace the comfort pad screw with a T6 Torx screwdriver to secure the comfort pad to the Trigger Assembly. Torque screw to 2 kgf-cm.

Converting Between Trigger and Triggerless Configuration

The RS6000 can be converted between Trigger and Triggerless configurations.

Convert to Trigger Assembly

To convert from Triggerless Assembly to Trigger Assembly:

1. Turn the RS6000 upside-down.
2. Remove the Large Comfort Pad. See [Large Comfort Pad Removal on page 285](#).
3. Remove and save the four screws from the Triggerless Assembly using a T6 Torx screwdriver.

Figure 63 Removal of Triggerless Assembly

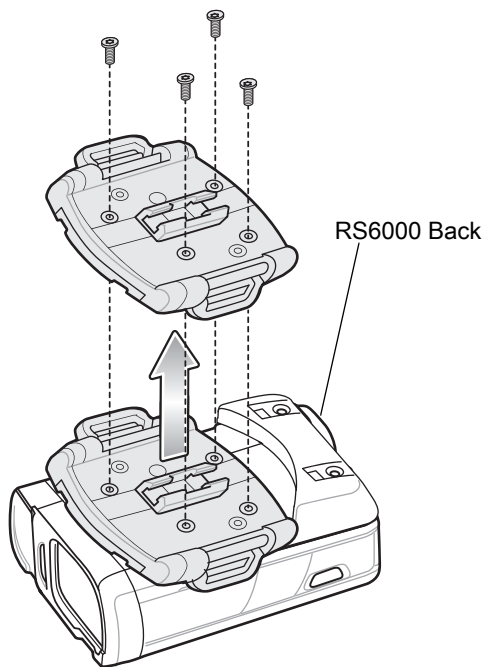

4. Lift the Triggerless Assembly off the housing.
5. Remove the O ring from the Triggerless Assembly and install onto the contact block.

Figure 64 Transfer O Ring

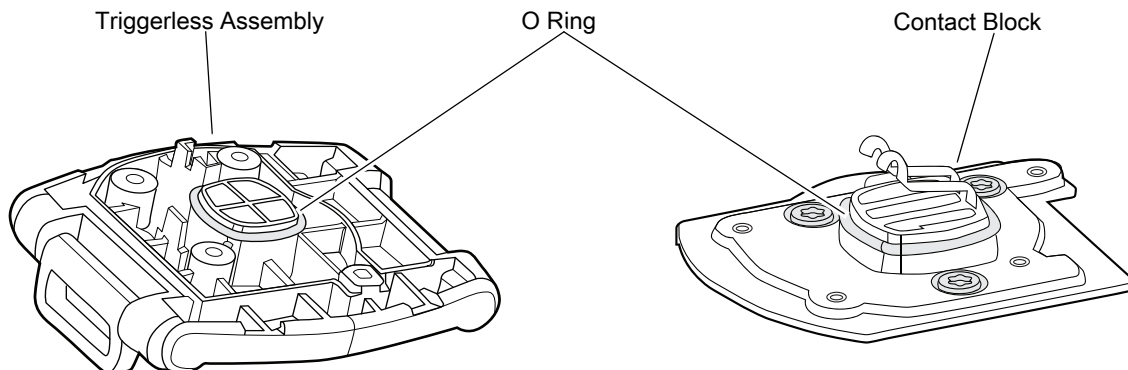

- Using the saved screws from the Triggerless Assembly, install the contact block onto the RS6000 with a T6 Torx screwdriver. Torque screws to 2 kgf-cm.

Figure 65 Installing Contact Block

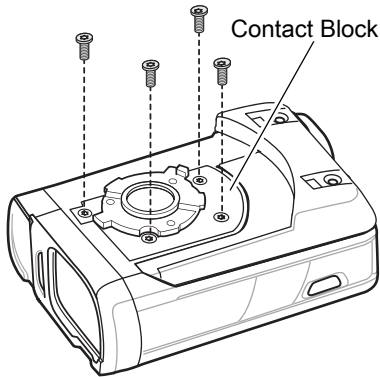

- Install the Trigger Assembly. See [Trigger Assembly Installation on page 288](#).

Convert to Triggerless Assembly

To convert from the Trigger Assembly to the Triggerless Assembly:

- Turn the RS6000 upside-down.
- Remove the Trigger Assembly. See [Trigger Assembly Removal on page 288](#).
- Remove and save the four screws securing the contact block to the housing using a T6 Torx screwdriver.
- Lift the contact block off the RS6000.
- Remove the O ring from the contact block and install it on the Triggerless Assembly. See [Figure 64](#).
- Lower the Triggerless Assembly onto the RS6000.

Figure 66 Installing Triggerless Assembly

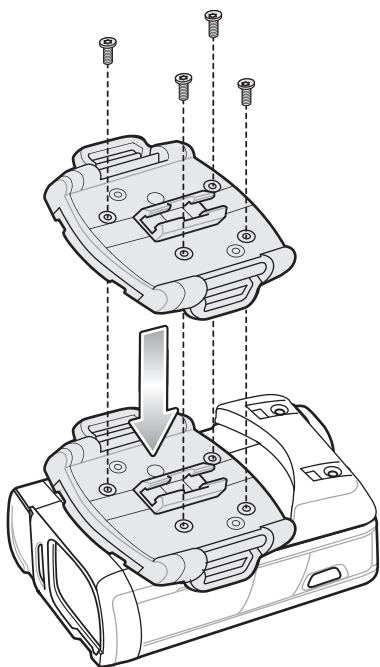

7. Using the four screws removed from the contact block, install the Triggerless Assembly using a T6 Torx screwdriver. Torque screws to 2 kgf-cm.
8. Install the Large Comfort Pad. See [Large Comfort Pad Installation on page 287](#).

Finger Strap Replacement (Trigger Swivel Assembly)

Finger Strap Removal (Trigger Swivel Assembly)

1. Remove the hook and loop Finger Strap from the Strap Buckle.

Figure 67 Finger Strap Removal (Trigger Swivel Assembly)

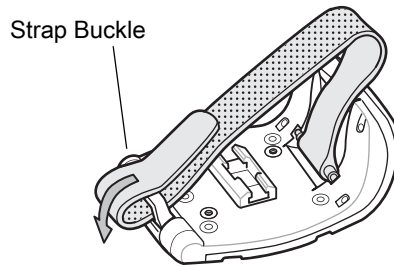

2. Push the Strap Pin down and pull the Finger Strap to remove the Strap Pin out of the Trigger Swivel Assembly.

Figure 68 Strap Pin Removal (Trigger Swivel Assembly)

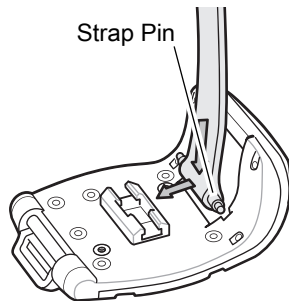

Finger Strap Installation (Trigger Swivel Assembly)

1. Align the Strap Pin of a new Finger Strap with the slot in the Trigger Swivel Assembly.

Figure 69 Finger Strap Pin Replacement (Trigger Swivel Assembly)

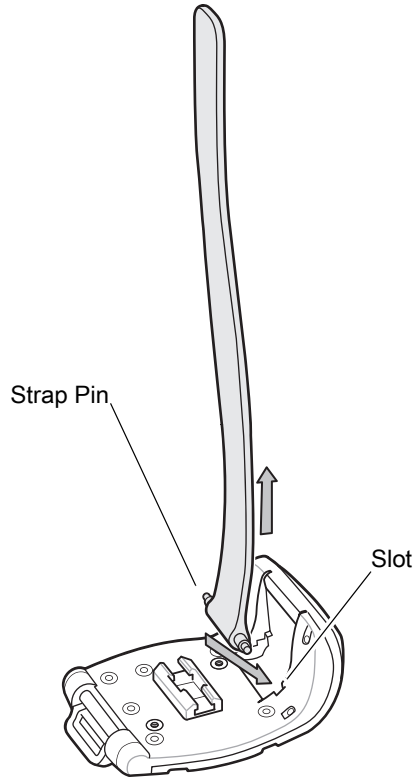

2. Guide the Strap Pin into the slots of the Trigger Swivel Assembly.
3. Pull up on the strap to snap the Strap Pin into the slots.
4. Slip the Finger Strap through the Strap Buckle.

Figure 70 Finger Strap Buckle Replacement (Trigger Swivel Assembly)

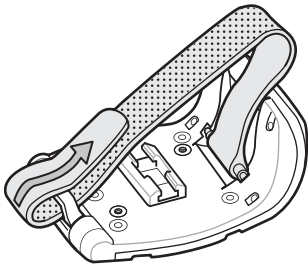

Finger Strap Replacement (Trigger Swivel Assembly with Cam Buckle)

Finger Strap Removal (Trigger Swivel Assembly with Cam Buckle)

1. Use finger tip to press the strap release latch on the Cam Buckle.

Figure 71 Press Strap Release (Trigger Swivel Assembly with Cam Buckle)

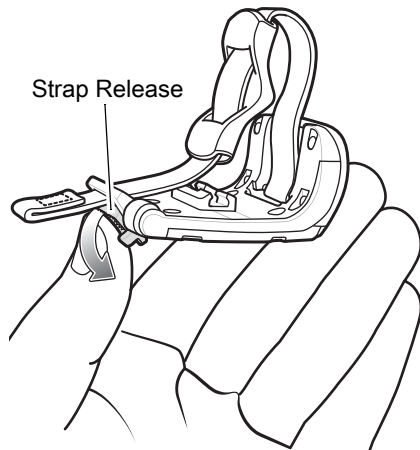

2. Remove the Finger Strap from the Cam Buckle.

Figure 72 Remove Finger Strap (Trigger Swivel Assembly with Cam Buckle)

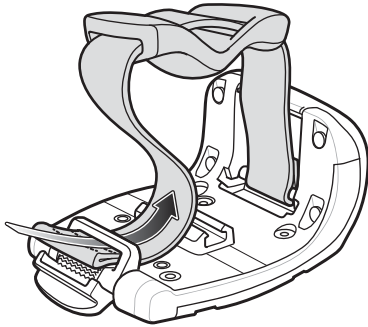

3. Remove the finger wedge from the strap and set aside.

Figure 73 Remove Finger Wedge (Trigger Swivel Assembly with Cam Buckle)

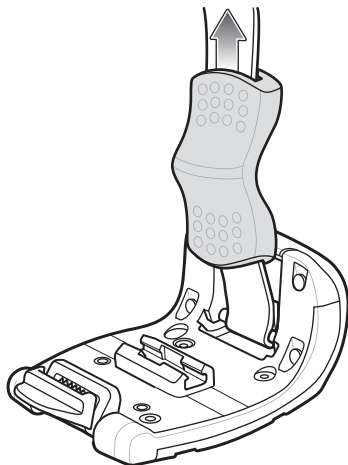

4. Push the Strap Pin down and pull the Finger Strap to remove the Strap Pin out of the Trigger Swivel Assembly.

Figure 74 Remove Finger Strap from Trigger Swivel Assembly (Trigger Swivel Assembly with Cam Buckle)

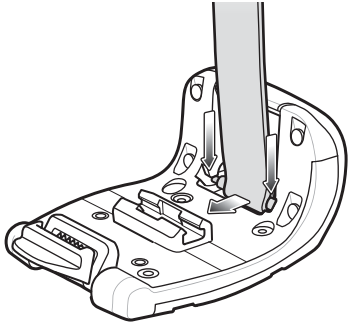

Finger Strap Installation (Trigger Swivel Assembly with Cam Buckle)

1. Align the Strap Pin of a new Finger Strap with the slot in the Trigger Swivel Assembly.

Figure 75 Finger Strap Pin Replacement (Trigger Swivel Assembly with Cam Buckle)

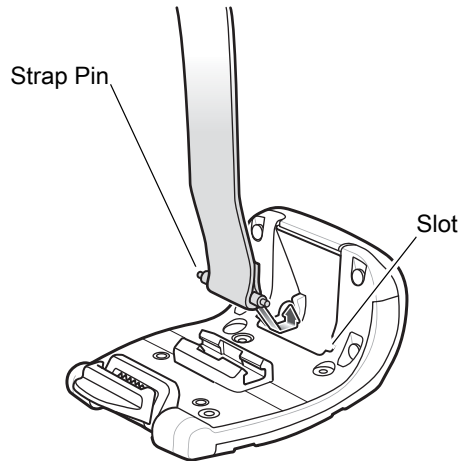

2. Guide the Strap Pin into the slots of the Trigger Swivel Assembly.
3. Pull up on the strap to snap the Strap Pin into the slots.
4. Install the finger wedge on the strap.

Figure 76 Install Finger Wedge (Trigger Swivel Assembly with Cam Buckle)

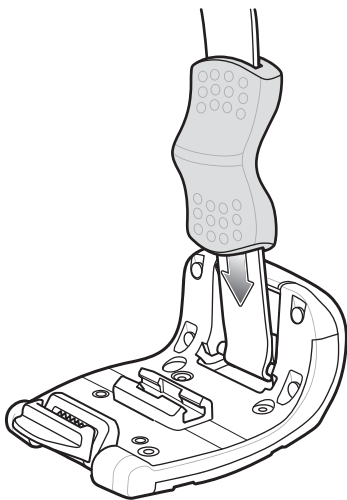

5. Slip the Finger Strap through the Cam Buckle.

Figure 77 Install Finger Strap (Trigger Swivel Assembly with Cam Buckle)

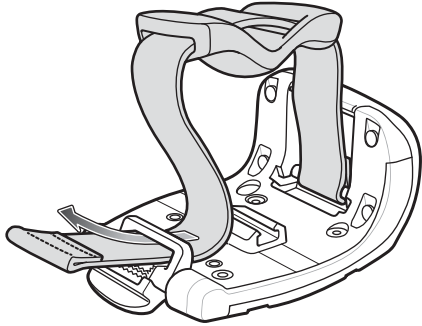

6. Press the cam buckle closed.

Figure 78 Close Cam Buckle (Trigger Swivel Assembly with Cam Buckle)

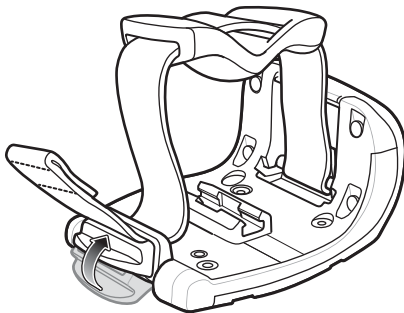

Finger Strap Replacement (Triggerless Strap Holder)

Finger Strap Removal (Triggerless Strap Holder)

1. Remove Finger Strap from the Strap Buckle from one side of the Triggerless Swivel Assembly.

Figure 79 Remove Finger Strap (Triggerless Strap Holder)

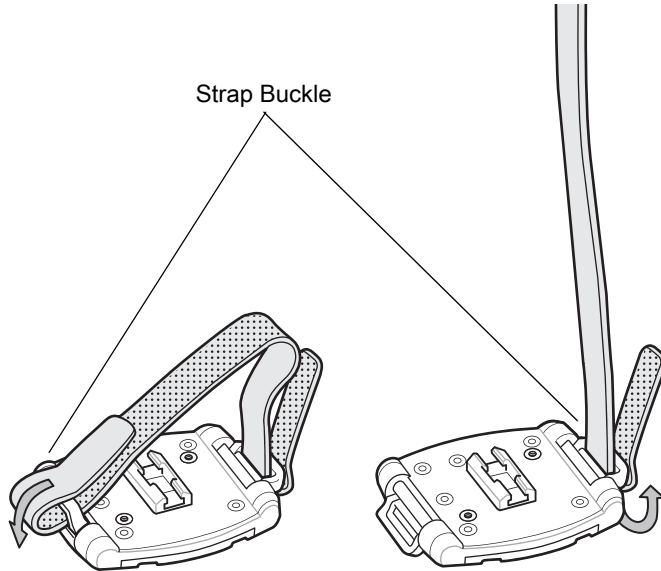

2. Remove Finger Strap from the Strap Buckle on the other side of the Triggerless Swivel Assembly.

Finger Strap Installation (Triggerless Strap Holder)

1. Slip the Finger Strap through the Strap Buckle on one side of the Triggerless Swivel Assembly.

Figure 80 Install Finger Strap (Triggerless Strap Holder)

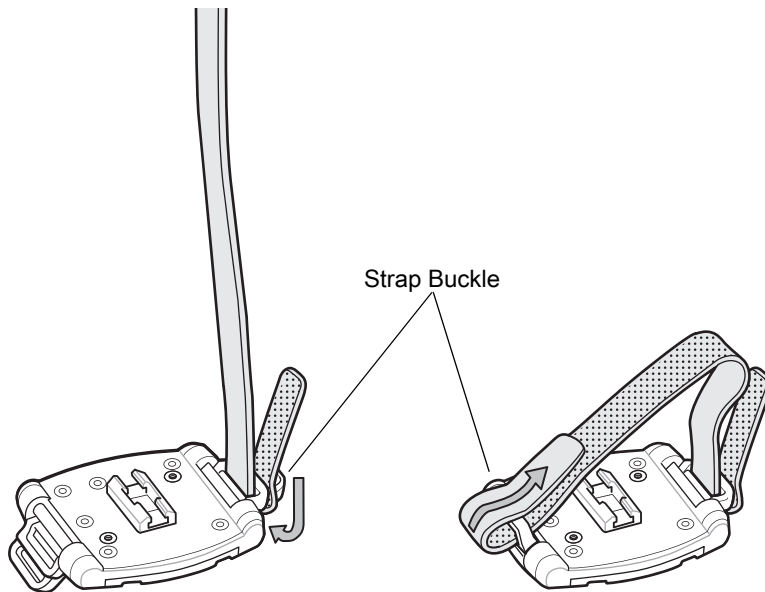

2. Slip the Finger Strap through the Strap Buckle on the other side of the Triggerless Swivel Assembly.

Strap Buckle Replacement

Strap Buckle Removal

1. Remove the Triggered or Triggerless Swivel Assembly (see [Trigger Assembly Replacement on page 288](#)).
2. Press the Strap Buckle off the Trigger Swivel Assembly Pin.

Figure 81 Strap Buckle Removal

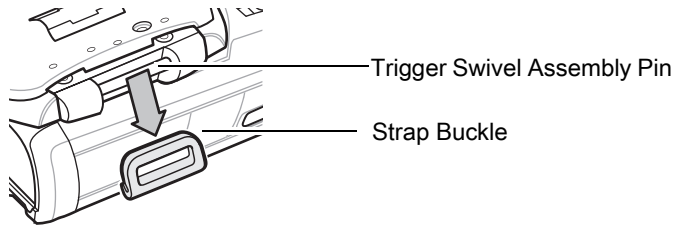

Strap Buckle Installation

1. Align the pin slot of Strap Buckle with the pin of the Trigger Swivel Assembly.

Figure 82 Strap Buckle Installation

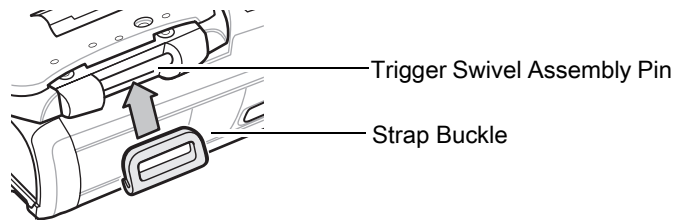

2. Press the Strap Buckle on to Trigger Swivel Assembly Pin. The pin slot snaps onto the pin.
3. Install the Trigger Swivel Assembly (see [Trigger Assembly Replacement on page 288](#)).

Troubleshooting

RS6000

Table 17 RS6000 Troubleshooting

Problem	Cause	Solution
Laser aiming pattern does not display when pressing the Scan Trigger.	Battery is not charged.	Replace or charge battery.
	Power is not applied to RS6000.	Replace or charge RS6000 battery.
	Scan application on the mobile computer is not functioning.	Restart the scanning application on the mobile computer.
	RS6000 does not respond.	Reset the RS6000 (See Resetting the RS6000 on page 25).
RS6000 does not decode a bar code.	Bar code is unreadable.	Verify that the bar code is not defective, i.e., smudged or damaged.
	Exit window is dirty.	Clean exit window with a lens tissue. Tissues for eyeglasses work well. Do not use tissues coated with lotion (see Cleaning the RS6000 on page 283).
	Bar code symbology is not supported or enabled.	See your system administrator.
	Bluetooth link is disconnected.	Reestablish Bluetooth connection (See Reconnecting on page 66).



NOTE: If after performing these checks the RS6000 still experiences problems, contact the distributor or call Zebra Support. See [Service Information on page 16](#).

Cradles

Table 18 RS6000 Troubleshooting

Problem	Cause	Solution
Device battery is not charging.	Device was removed from cradle or cradle was unplugged from AC power.	Ensure cradle is receiving power. Ensure device is seated correctly. Confirm main battery is charging. The battery fully charges in approximately four hours.
	Battery is faulty.	Verify that other batteries charge properly. If so, replace the faulty battery (see Install the Battery on page 21).
	The device is not fully seated in the cradle.	Remove and re-insert the device into the cradle, ensuring it is firmly seated.
	Ambient temperature of the cradle is too warm or too cold.	Move the cradle to an area where the ambient temperature is between 0 °C and 40 °C (32 °F and 104 °F).



NOTE: If after performing these checks the RS6000 still experiences problems, contact the distributor or call Zebra Support. See [Service Information on page 16](#).

Specifications

RS6000 Technical Specifications

The following tables summarize the RS6000's intended operating environment and general technical hardware specifications.

Table 19 RS6000 Technical Specifications

Item	Description
Physical Characteristics	
Dimensions (H x W x L):	Triggered: 74 mm (2.9 in.) x 54 mm (2.1 in.) x 53 mm (2.1 in.) Triggerless: 74 mm (2.9 in.) x 54 mm (2.1 in.) x 33 mm (1.3 in.)
Weight:	Triggered, with battery: 183 g / 6.46 oz. Triggerless, with battery: 170 g / 6.00 oz.
Power	3350 mAh capacity; PowerPrecision+; Li-Ion Battery Pack
Performance Characteristics	
Optical Resolution:	1280 x 960 pixels
Roll:	360°
Pitch Angle:	± 60° from normal
Skew Tolerance:	± 60° from normal
Aiming Element:	655 nm Laser
Illumination Element	Two (2) warm white light LEDs
Field of View:	SR: Horizontal: 48°, Vertical: 36.7° MR: Horizontal: 31°, Vertical: 23°
Standard Range Focus Typical Working Distance	See Decode Distances on page 310 .
Medium Range Focus Typical Working Distance	See Decode Distances on page 310 .

Specifications

Table 19 RS6000 Technical Specifications (Continued)

Item	Description
Ambient Light Immunity (from total darkness):	Indoor: 450 ft. candles (4,845 lux). Outdoor Triggered: 9,000 ft. candles (96,900 lux). Outdoor Triggerless: up to 2,000 ft. candles (25,528 lux).
Motion Tolerance:	63.5 cm (25 in.) per second, typical
Supported Symbologies	<p>1D enabled by default: Codebar, Code 39, Code 128, EAN-13, EAN-8, Interleaved 2 of 5, UPC-A and UPC-E.</p> <p>1D disabled by default: Code 11, Code 32 Pharmaceutical (PARAF), Code 93, MSI, Reduced Space Symbology (RSS-14, RSS Limited, RSS Expanded), Straight 2 of 5 IATA (two-bar start/stop), Straight 2 of 5 Industrial (three-bar start/stop), Trioptic, UPC-E1, USPS GS1-128, ISBT-128, JAN-8, JAN-13, BN/Brookland, ISSN, Coupon Code, Discrete 2 of 5, Chinese 2 of 5, Matrix 2 of 5, Composite (CC-A, CC-B, CC-C), EAN, UCC Composite, OCR-A, OCR-B.</p> <p>2D enabled by default: 4-CB (4-State Customer Bar code), Aztec, MicroPDF417, PDF417, MaxiCode.</p> <p>2D disabled by default: Australian Post, British Post (4 state code and “infomail”), Data Matrix, Japanese Post, KIX (Netherlands) Post, Planet Code, Postnet, QR Code, TCIF Linked Code 39 (TLC39), Canada Post, Royal Mail Mailmark, USPS, OneCode/Intelligent Mail, UPU FICS Postal, OCR-A, OCR-B, Han Xin.</p> <p>OCR disabled by default: OCR-A, OCR-B, MICR E13B, US Currency</p>
Supported Aiming Modes:	Class 2 Laser, cross hair with bright center for sunlight visibility; Pick List mode option configurable.
Interface:	<p>Bluetooth: Class I, v 4.0 with Bluetooth Low Energy (BLE). Supported Profiles: Serial Port Profile (SPP), Human Interface Device Profile (HID), Service Discovery Application Profile (SDAP). NFC Tag: Tap-to-Pair; used to simplify the pairing process. Pairing: by reading terminal Bluetooth address as bar code of the host device or from a printed label.</p>
Field Replaceable Parts:	Battery, trigger module, triggerless module, comfort pad, straps and strap buckle.
User Interface	
LED:	<p>Line of Sight (LOS) Two (2) RGB LEDs located at the back side of the device (programmable)</p> <p>Radio and Battery capacity status - One (1) RGB LED located on the top side of the device</p>

Specifications

Table 19 RS6000 Technical Specifications (Continued)

Item	Description
Beeper:	Back of the device, minimum 85 dBA at 10 cm with High Tone / High Volume.
Restore Key:	User accessible for emergency warm boot and Bluetooth reconnect (after disconnect timeout).
Scan Triggering:	Manual or automatic using Interactive Sensor Technology (IST) (Accelerometer/ Proximity)
User Environment	
Operating Temperature:	-30°C (-22°F) to +50°C (+122°F).
Storage Temperature:	-40°C (-40°F) to +60°C (+140°F) incl. battery -40°C (-40°F) to +70°C (+158°F) excl. battery
Sealing	IEC 60529: IP65
Humidity:	5% to 95% (non-condensing).
Drop Specification:	6 ft./1.8 m multiple drops to concrete across operating temperature range.
Tumble	1,000 tumbles @ 0.5 m (room temperature)
Vibration	Sine 5-2000 Hz, 4g peak, one hour per axis Random 20-2000 Hz, 6g RMS or 0.04g2/Hz, one hour per axis
Electrostatic Discharge (ESD):	+/-20 kVdc air discharge +/-10 kVdc contact discharge
Power	
	Li-Ion 3350 mAh, 3.6V with up to 100,000 scans or up to 80+ hours with 1440 scans per hour on a single charge using a battery with ≤ 100 charge/discharge cycles
Software Compatibility	
	123Scan2, DataWedge and MDM solutions (using Zebra MDM toolkit)
Peripherals and Accessories	
Battery charger:	1-Slot RS6000 Charging Cradle 2-Slot WT6000/RS6000 Charging Cradle 5-Slot RS6000 Charge Only Cradle 10-Slot WT6000/RS6000 Charge Only Cradle 10-Slot RS6000 Charge Only Cradle 4-Slot Battery Charger 20-Slot Battery Charger
Regulatory	
Electrical Safety:	Certified to UL60950-1, CSA C22.2 No. 60950-1, EN60950-1, IEC 60950-1
Laser Safety:	CDRH Class II, IEC 60825-1 Class 2.

Table 19 RS6000 Technical Specifications (Continued)

Item	Description
LED Safety	Classified as Exempt Risk Group per IEC/EN 62471
EMI/RFI:	FCC Part 15 Class B, ICES-003 Class B, European Union EMC and R&TT. Directives, Australian AS/NZS 60950.1.
RoHS:	Compliance with RoHS standards.

Cradle Technical Specifications

1-Slot RS6000 USB Charging Cradle Technical Specifications

Table 20 1-Slot RS6000 USB Charging Cradle Technical Specifications

Item	Description
Dimensions	Height: 76.3 mm (3.0 in.) Width: 97.5 mm (3.84 in.) Depth: 134.5 mm (5.3 in.)
Weight	418 g (14.74 oz.)
Input Voltage	12 VDC
Power Consumption	11.256 watts
Operating Temperature	0°C to 50°C (32°F to 122°F)
Storage Temperature	-40°C to 70°C (-40°F to 158°F)
Charging Temperature	0°C to 40°C (32°F to 104°F)
Humidity	5% to 95% non-condensing
Drop	76.2 cm (30.0 in.) drops to concrete at room temperature.
Electrostatic Discharge (ESD)	+/- 20 kV air discharge +/- 10 kV contact discharge

2-Slot WT6000/RS6000 Charging Cradle Technical Specifications

Table 21 2-Slot WT6000/RS6000 Charging Cradle Technical Specifications

Item	Description
Dimensions	Height: 81.8 mm (3.22 in.) Width: 97.5 mm (3.84 in.) Depth: 134.5 mm (5.3 in.)
Weight	448 g (15.8 oz.)
Input Voltage	12 VDC
Power Consumption	13.716 watts
Operating Temperature	0°C to 50°C (32°F to 122°F)
Storage Temperature	-40°C to 70°C (-40°F to 158°F)
Charging Temperature	0°C to 40°C (32°F to 104°F)
Humidity	0% to 95% non-condensing

Specifications

Table 21 2-Slot WT6000/RS6000 Charging Cradle Technical Specifications (Continued)

Item	Description
Drop	76.2 cm (30.0 in.) drops to concrete at room temperature.
Electrostatic Discharge (ESD)	+/- 20 kV air discharge +/- 10 kV contact discharge

5-Slot RS6000 Charge Only Cradle Technical Specifications

Table 22 5-Slot RS6000 Charge Only Cradle Technical Specifications

Item	Description
Dimensions	Height: 80.7 mm (3.17 in.) Width: 489.0 mm (19.25 in.) Depth: 134.5 mm (5.3 in.)
Weight	2122 g (74.85 oz.)
Input Voltage	12 VDC
Power Consumption	57.12 watts
Operating Temperature	0°C to 50°C (32°F to 122°F)
Storage Temperature	-40°C to 70°C (-40°F to 158°F)
Charging Temperature	0°C to 40°C (32°F to 104°F)
Humidity	0% to 95% non-condensing
Drop	76.2 cm (30.0 in.) drops to concrete at room temperature.
Electrostatic Discharge (ESD)	+/- 20 kV air discharge +/- 10 kV contact discharge

10-Slot WT6000/RS6000 Charge Only Cradle Technical Specifications

Table 23 10-Slot WT6000/RS6000 Charge Only Cradle Technical Specifications

Item	Description
Dimensions	Height: 86.3 mm (3.39 in.) Width: 489.0 mm (19.25 in.) Depth: 134.5 mm (5.3 in.)
Weight	2164 g (76.33 oz.)
Input Voltage	12 VDC
Power Consumption	65.76 watts
Operating Temperature	0°C to 50°C (32°F to 122°F)
Storage Temperature	-40°C to 70°C (-40°F to 158°F)

Table 23 10-Slot WT6000/RS6000 Charge Only Cradle Technical Specifications (Continued)

Item	Description
Charging Temperature	0°C to 40°C (32°F to 104°F)
Humidity	5% to 95% non-condensing
Drop	76.2 cm (30.0 in.) drops to concrete at room temperature.
Electrostatic Discharge (ESD)	+/- 20 kV air discharge +/- 10 kV contact discharge

10-Slot RS6000 Charge Only Cradle Technical Specifications

Table 24 10-Slot RS6000 Charge Only Cradle Technical Specifications

Item	Description
Dimensions	Height: 80.7 mm (3.17 in.) Width: 489.0 mm (19.25 in.) Depth: 134.5 mm (5.3 in.)
Weight	2198 g (77.53 oz.)
Input Voltage	12 VDC
Power Consumption	58.68 watts
Operating Temperature	0°C to 50°C (32°F to 122°F)
Storage Temperature	-40°C to 70°C (-40°F to 158°F)
Charging Temperature	0°C to 40°C (32°F to 104°F)
Humidity	5% to 95% non-condensing
Drop	76.2 cm (30.0 in.) drops to concrete at room temperature.
Electrostatic Discharge (ESD)	+/- 20 kV air discharge +/- 10 kV contact discharge

4-Slot Battery Charger Technical Specifications

Table 25 4-Slot Battery Charger Technical Specifications

Item	Description
Dimensions	Height: 62.4 mm (3.46 in.) Width: 97.5 mm (3.84 in.) Depth: 134.5 mm (5.3 in.)
Weight	422 g (14.89 oz.)
Input Voltage	12 VDC
Power Consumption	16.368 watts

Specifications

Table 25 4-Slot Battery Charger Technical Specifications

Item	Description
Operating Temperature	0°C to 40°C (32°F to 104°F)
Storage Temperature	-40°C to 70°C (-40°F to 158°F)
Charging Temperature	0°C to 40°C (32°F to 104°F)
Humidity	5% to 95% non-condensing
Drop	76.2 cm (30.0 in.) drops to concrete at room temperature.
Electrostatic Discharge (ESD)	+/- 20 kV air discharge +/- 10 kV contact discharge

20-Slot Battery Charger Technical Specifications

Table 26 20-Slot Battery Charger Technical Specifications

Item	Description
Dimensions	Height: 66.9 mm (2.63 in.) Width: 489.0 mm (19.25 in.) Depth: 134.5 mm (5.3 in.)
Weight	2172 g (76.62 oz.)
Input Voltage	12 VDC
Power Consumption	97.8 watts
Operating Temperature	0°C to 40°C (32°F to 104°F)
Storage Temperature	-40°C to 70°C (-40°F to 158°F)
Charging Temperature	0°C to 40°C (32°F to 104°F)
Humidity	5% to 95% non-condensing
Drop	76.2 cm (30.0 in.) drops to concrete at room temperature.
Electrostatic Discharge (ESD)	+/- 20 kV air discharge +/- 10 kV contact discharge

Decode Distances

Table 27 Decode Distances

Bar Code Type	Symbol Density	Standard Focus Range Typical Working Ranges		Medium Focus Range Typical Working Ranges	
		Near	Far	Near	Far
Code 39	3 mil	3.7 in	5.4 in	N/A	N/A
	20 mil	1.6* in	30 in	2.1* in	45 in
	100 mil	N/A	N/A	11 in	127 in
Code 128	5 mil	3.2 in	7.6 in	8.2 in	15 in
	15 mil	2.4* in	22 in	4* in	34 in
PDF 417	5 mil	4 in	7 in	9.3 in	12.5 in
	6.67 mil	2.9 in	9 in	N/A	N/A
DataMatrix	7.5 mil	N/A	N/A	9.1 in	12 in
	10 mil	3 in	9.4 in	7.8 in	16.5 in
	160 mil	N/A	N/A	11.5 in	105 in
100% UPCA	13 mil	1.8* in	20 in	2.3* in	33 in

Decode Range Information

Standard Range Decode Zone

Figure shows the decode zone for the RS6000 Standard Range. Typical values appear for selected bar code densities. The minimum element width (or “symbol density”) is the width in mils of the narrowest element (bar or space) in the symbol.

Figure 83 RS6000 Standard Range Decode Zone

Note: Typical performance at 73°F (23°C)
on high quality symbols in normal room light.

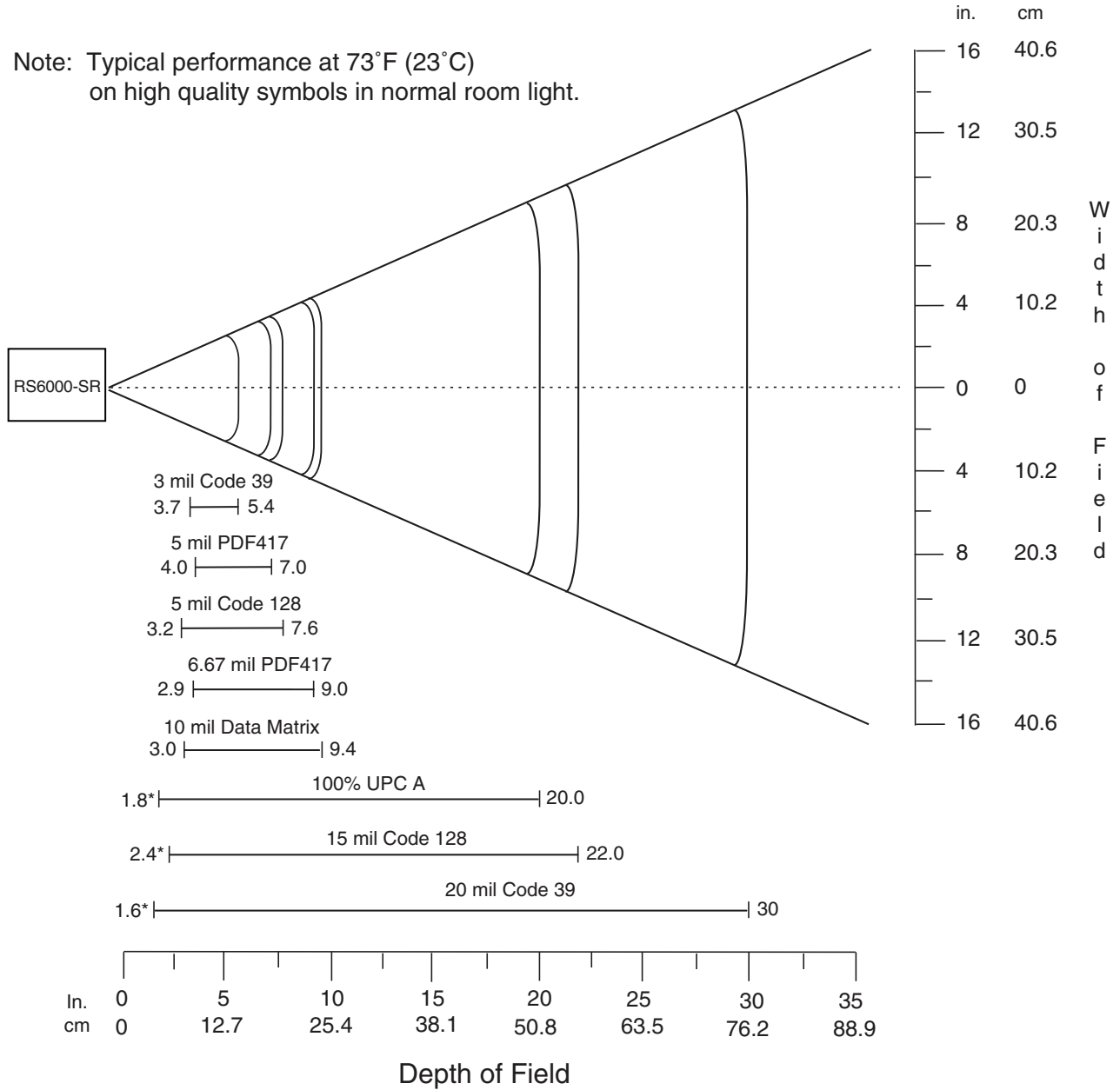

* Limited by width of bar code in field of view

✓ **NOTE:** Distances measured from scan engine chassis.

Medium Range Decode Zone

Figure 84 shows the decode zone for the RS6000 Medium Range. Typical values appear for selected bar code densities. The minimum element width (or “symbol density”) is the width in mils of the narrowest element (bar or space) in the symbol.

Figure 84 RS6000 Medium Range Decode Zone

Note: Typical performance at 73°F (23°C)
on high quality symbols in normal room light.

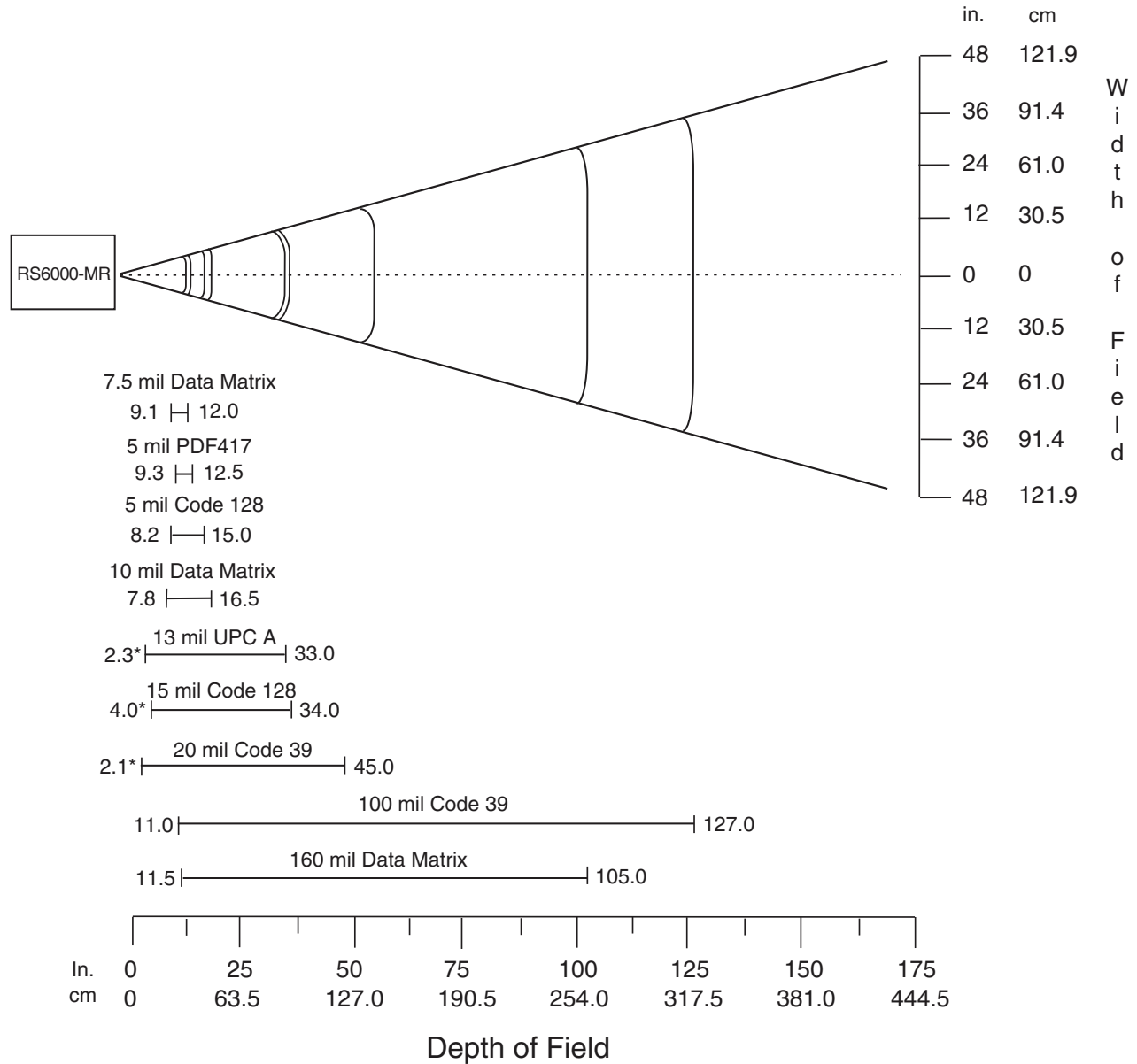

* Limited by width of bar code in field of view

✓ **NOTE:** Distances measured from scan engine chassis.

Standard Default Parameters

Standard Default Parameters Table

Table 28 Standard Default Parameters Table

Parameter	Parameter Number	Default	Page Number
Bluetooth Communications			
Bluetooth Communications Host Types		SSI Bluetooth Classic	30
Discoverable Mode	610	General	57
Wi-Fi Friendly Mode		Disable	61
Wi-Fi Friendly Channel Exclusion		Use All Channels	62
Radio Output Power	1324	Class 2	64
Link Supervision Timeout	1698	.5 Seconds	65
HID Wait for Connection	1714	Disable	34
HID Features for Apple iOS	1114	Disable	35
HID Keyboard Keystroke Delay		No Delay (0 msec)	35
CAPS Lock Override		Disable	36
Ignore Unknown Characters		Enable	36
Emulate Keypad		Disable	37
Fast HID Keyboard	1361	Enable	37
Quick Keypad Emulation	1362	Enable	38
Keyboard FN1 Substitution		Disable	38
Function Key Mapping		Disable	39
Simulated Caps Lock		Disable	39
Convert Case		No Case Conversion	40
Beep on Reconnect Attempt	559	Disable	67

Standard Default Parameters

Table 28 Standard Default Parameters Table (Continued)

Parameter	Parameter Number	Default	Page Number
Reconnect Attempt Interval	558	30 sec	68
Auto-reconnect	604	Auto-reconnect Immediately	70
Bluetooth Disconnect Indication	822	Disable	71
Bluetooth Disconnect Indication After Battery Insert	823	120 sec	72
Bluetooth Disconnect Indication After Bluetooth Disconnection	824	30 sec	73
Bluetooth Disconnect Indication - Cycle Time		10 sec	74
Bluetooth Disconnect Indication - Beep Type		3 High/Short Beeps	75
Beep on Insertion	288	Enable	118
Beep on <BEL>	150	Enable	51
Toggle Pairing	1322	Disable	76
Force Pairing Save	795	Enable	76
Auto Unpairing	1708	Disable	77
Batch Mode	544	Normal (Do Not Batch Data)	79
PIN Code (Set and Store)	552	12345	58
Variable Pin Code	608	Static (Default PIN code is 12345)	59
Bluetooth Security Levels	1393	Low	60
Motion and Proximity			
Motion Sensing Control		Enable	108
Motion Sensitivity		Normal	108
Proximity Sensing Control		Enable	109
Proximity Continuous Enable		Disable	109
Proximity Distance		Long Range	110
Good Scan Indication Delay Control		600 msec	111
User Preferences			
Set Default Parameter		Set Defaults	116
Parameter Bar Code Scanning	ECh	Enabled	117
Beep After Good Decode	38h	Enabled	118

Standard Default Parameters

Table 28 Standard Default Parameters Table (Continued)

Parameter	Parameter Number	Default	Page Number
Beep on Insertion	288	Enabled	118
Beeper Tone	91h	High	120
Beeper Volume	8Ch	High	119
Beeper Duration	F1 74h	Medium	121
Suppress Power Up Beeps	721	Do Not Suppress	121
Low Battery Indication	779	Enable	122
Hand-Held Trigger Mode	138	Level	123
Hand-Held Decode Aiming Pattern	306	Enable	124
Picklist Mode	402	Disabled Always	125
FIPS Mode	736	Disable	126
Continuous Bar Code Read	649	Disable	127
Unique Bar Code Reporting	723	Enable	127
Decode Session Timeout	136	9.9 Sec	128
Timeout Between Decodes, Same Symbol	137	0.5 Sec	129
Timeout Between Decodes, Different Symbols	144	0.1 sec	130
Fuzzy 1D Processing	514	Enable	130
Decode Mirror Images (Data Matrix Only)	537	Auto	131
PDF Prioritization	719	Disable	133
PDF Prioritization Timeout	720	200 ms	134
Decoding Illumination	298	Enable	134
Motion Tolerance	858	Less Motion Tolerance	135
Miscellaneous Options			
Add an Enter Key	N/A	N/A	135
Transmit Code ID Character	45	None	135
Prefix Value	99, 105	7013 <CR><LF>	136
Suffix 1 Value	98, 104	7013 <CR><LF>	136
Suffix 2 Value	100, 106		
Scan Data Transmission Format	235	Data as is	137
FN1 Substitution Values	103, 109	7013 <CR><LF>	139
Transmit "No Read" Message	94	Disable	140
Picklist Mode	F0h 92h	Disabled	125

Standard Default Parameters

Table 28 Standard Default Parameters Table (Continued)

Parameter	Parameter Number	Default	Page Number
Fuzzy 1D Processing	F1h 02h	Enabled	130
Decoding Illumination	F0h, 2Ah	Enabled	134
Symbologies			
Enable/Disable All Code Types			148
UPC/EAN			
UPC-A	1	Enable	149
UPC-E	2	Enable	149
UPC-E1	12	Disable	150
EAN-8/JAN 8	4	Enable	150
EAN-13/JAN 13	3	Enable	151
Bookland EAN	83	Disable	151
Decode UPC/EAN/JAN Supplementals (2 and 5 digits)	16	Ignore	152
User-Programmable Supplementals		000	155
Supplemental 1:	579		
Supplemental 2:	580		
UPC/EAN/JAN Supplemental Redundancy	80	10	155
Decode UPC/EAN/JAN Supplemental AIM ID	672	Combined	156
UPC Reduced Quiet Zone	1289	Disable	157
Transmit UPC-A Check Digit	40	Enable	157
Transmit UPC-E Check Digit	41	Enable	158
Transmit UPC-E1 Check Digit	42	Enable	158
UPC-A Preamble	34	System Character	159
UPC-E Preamble	35	System Character	160
UPC-E1 Preamble	36	System Character	161
Convert UPC-E to A	37	Disable	162
Convert UPC-E1 to A	38	Disable	162
EAN-8/JAN-8 Extend	39	Disable	163
Bookland ISBN Format	576	ISBN-10	164

Standard Default Parameters

Table 28 Standard Default Parameters Table (Continued)

Parameter	Parameter Number	Default	Page Number
UCC Coupon Extended Code	85	Disable	165
Coupon Report	730	New Coupon Format	166
ISSN EAN	617	Disable	167
Code 128			
Code 128	8	Enable	168
Set Length(s) for Code 128	209, 210	1 to 55	169
GS1-128 (formerly UCC/EAN-128)	14	Enable	171
ISBT 128	84	Enable	171
ISBT Concatenation	577	Autodiscriminate	172
Check ISBT Table	578	Enable	173
ISBT Concatenation Redundancy	223	10	173
Code 128 Security Level	751	Security Level 1	174
Code 128 Reduced Quiet Zone	1208	Disable	175
Ignore Code 128 <FNC4>	1254	Disable	175
Code 128 Exclusive	Param 673	Disable	176
Code 39			
Code 39	0	Enable	177
Trioptic Code 39	13	Disable	177
Convert Code 39 to Code 32 (Italian Pharmacy Code)	86	Disable	178
Code 32 Prefix	231	Disable	179
Set Length(s) for Code 39	18, 19	1 to 55	180
Code 39 Check Digit Verification	48	Disable	181
Transmit Code 39 Check Digit	43	Disable	181
Code 39 Full ASCII Conversion	17	Disable	182
Code 39 Security Level	750	Security Level 1	183
Code 39 Reduced Quiet Zone	1209	Disable	184
Code 39 Buffering - Scan and Store	113	Disable	184

Standard Default Parameters

Table 28 Standard Default Parameters Table (Continued)

Parameter	Parameter Number	Default	Page Number
Code 93			
Code 93	9	Enable	187
Set Length(s) for Code 93	26, 27	1 to 55	187
Code 11			
Code 11	10	Disable	189
Set Lengths for Code 11	28, 29	4 to 55	189
Code 11 Check Digit Verification	52	Disable	191
Transmit Code 11 Check Digit(s)	47	Disable	192
Interleaved 2 of 5 (ITF)			
Interleaved 2 of 5 (ITF)	6	Disable	193
Set Lengths for I 2 of 5	22, 23	6 to 55	194
I 2 of 5 Check Digit Verification	49	Disable	196
Transmit I 2 of 5 Check Digit	44	Disable	197
Convert I 2 of 5 to EAN 13	82	Disable	197
I 2 of 5 Security Level	1121	Security Level 1	198
I 2 of 5 Reduced Quiet Zone	1210	Disable	199
Discrete 2 of 5 (DTF)			
Discrete 2 of 5	5	Disable	200
Set Length(s) for D 2 of 5	20, 21	1 to 55	201
Codabar (NW - 7)			
Codabar	7	Enable	203
Set Lengths for Codabar	24, 25	4 to 55	203
CLSI Editing	54	Disable	205
NOTIS Editing	55	Disable	205
Codabar Upper or Lower Case Start/ Stop Characters Detection	855	Upper Case	206
MSI			
MSI	11	Disable	207
Set Length(s) for MSI	30, 31	4 to 55	207

Standard Default Parameters

Table 28 Standard Default Parameters Table (Continued)

Parameter	Parameter Number	Default	Page Number
MSI Check Digits	50	One	209
Transmit MSI Check Digit	46	Disable	209
MSI Check Digit Algorithm	51	Mod 10/Mod 10	210
Chinese 2 of 5			
Chinese 2 of 5	408	Disable	211
Matrix 2 of 5			
Matrix 2 of 5	618	Disable	212
Matrix 2 of 5 Lengths	619 620	4 to 55	212
Matrix 2 of 5 Check Digit	622	Disable	214
Transmit Matrix 2 of 5 Check Digit	623	Disable	214
Korean 3 of 5			
Korean 3 of 5	581	Disable	215
Inverse 1D	586	Regular	216
GS1 DataBar			
GS1 DataBar-14	338	Enable	217
GS1 DataBar Limited	339	Enable	217
GS1 DataBar Expanded	340	Enable	218
Convert GS1 DataBar to UPC/EAN	397	Disable	218
GS1 DataBar Limited Security Level	728	Level 3	219
Composite			
Composite CC-C	341	Disable	220
Composite CC-A/B	342	Disable	220
Composite TLC-39	371	Disable	221
UPC Composite Mode	344	UPC Never Linked	222
Composite Beep Mode	398	Beep As Each Code Type is Decoded	223
GS1-128 Emulation Mode for UCC/EAN Composite Codes	427	Disable	223

Standard Default Parameters

Table 28 Standard Default Parameters Table (Continued)

Parameter	Parameter Number	Default	Page Number
2D Symbolologies			
PDF417	15	Enable	224
MicroPDF417	227	Disable	224
Code 128 Emulation	123	Disable	225
Data Matrix	292	Enable	226
GS1 Data Matrix	1336	Disable	226
Data Matrix Inverse	588	Inverse Autodetect	227
Maxicode	294	Disable	227
QR Code	293	Enable	228
GS1 QR	1343	Disable	228
MicroQR	573	Enable	229
Inverse QR	587	Regular	229
Aztec	574	Enable	230
Aztec Inverse	589	Inverse Autodetect	230
Han Xin	1167	Disable	231
Han Xin Inverse	1168	Regular	231
Postal Codes			
US Postnet	89	Disable	232
US Planet	90	Disable	232
Transmit US Postal Check Digit	95	Enable	233
UK Postal	91	Disable	233
Transmit UK Postal Check Digit	96	Enable	234
Japan Postal	290	Disable	234
Australia Post	291	Disable	235
Australia Post Format	718	Autodiscriminate	236
Netherlands KIX Code	326	Disable	237
USPS 4CB/One Code/Intelligent Mail	592	Disable	237
UPU FICS Postal	611	Disable	238
Mailmark	1337	Disable	238

Standard Default Parameters

Table 28 Standard Default Parameters Table (Continued)

Parameter	Parameter Number	Default	Page Number
Canada Post	92	Disable	239
Symbology-Specific Security Levels			
Redundancy Level	78	1	240
Security Level	77	1	242
1D Quiet Zone Level	1288	1	243
Intercharacter Gap Size	381	Normal	244
Report Version			244
Macro PDF			
Flush Macro PDF Buffer	N/A	N/A	245
Abort Macro PDF Entry	N/A	N/A	245
OCR Programming Parameters			
OCR-A	680	Disable	248
OCR-A Variant	684	Full ASCII	248
OCR-B	681	Disable	250
OCR-B Variant	685	Full ASCII	251
MICR E13B	682	Disable	254
US Currency	683	Disable	255
OCR Orientation	687	0°	255
OCR Lines	691	1	257
OCR Minimum Characters	689	3	257
OCR Maximum Characters	690	100	258
OCR Subset	686	Selected font variant	258
OCR Quiet Zone	695	50	259
OCR Template	547	54R	260
OCR Check Digit Modulus	688	1	269
OCR Check Digit Multiplier	700	121212121212	270
OCR Check Digit Validation	694	None	271
Inverse OCR	856	Regular	276

Programming Reference

Symbol Code Identifiers

Table 29 Symbol Code Characters

Code Character	Code Type
A	UPC-A, UPC-E, UPC-E1, EAN-8, EAN-13
B	Code 39, Code 32
C	Codabar
D	Code 128
E	Code 93
F	Interleaved 2 of 5
G	Discrete 2 of 5, or Discrete 2 of 5 IATA
H	Code 11
J	MSI
K	GS1-128
L	Bookland EAN
M	Trioptic Code 39
N	Coupon Code
R	GS1 DataBar Family
T	UCC Composite, TLC 39
X	PDF417, Macro PDF417, Micro PDF417
z	Aztec, Aztec Rune
P00	Data Matrix
P01	QR Code, MicroQR
P02	Maxicode
P03	US Postnet

Table 29 Symbol Code Characters (Continued)

Code Character	Code Type
P04	US Planet
P05	Japan Postal
P06	UK Postal
P08	Netherlands KIX Code
P09	Australian Postal
P0A	USPS 4CB/One Code/Intelligent Mail
P0B	UPU FICS Postal

AIM Code Identifiers

Each AIM Code Identifier contains the three-character string **jcm** where:

- j = Flag Character (ASCII 93)
- c = Code Character (see [Table 30](#))
- m = Modifier Character (see [Table 31](#))

Table 30 Aim Code Characters

Code Character	Code Type
A	Code 39, Code 39 Full ASCII, Code 32
C	Code 128, Coupon (Code 128 portion)
d	Data Matrix
E	UPC/EAN, Coupon (UPC portion)
e	GS1 DataBar Family
F	Codabar
G	Code 93
H	Code 11
I	Interleaved 2 of 5
L	PDF417, Macro PDF417, Micro PDF417
M	MSI
Q	QR Code, MicroQR
S	Discrete 2 of 5, IATA 2 of 5
U	Maxicode

Table 30 Aim Code Characters (Continued)

Code Character	Code Type
z	Aztec, Aztec Rune
X	Bookland EAN, Trioptic Code 39, US Postnet, US Planet, UK Postal, Japan Postal, Australian Postal, Netherlands KIX Code, USPS 4CB/One Code/Intelligent Mail, UPU FICS Postal

The modifier character is the sum of the applicable option values based on [Table 31](#).

Table 31 Modifier Characters

Code Type	Option Value	Option
Code 39	0	No check character or Full ASCII processing.
	1	Reader has checked one check character.
	3	Reader has checked and stripped check character.
	4	Reader has performed Full ASCII character conversion.
	5	Reader has performed Full ASCII character conversion and checked one check character.
	7	Reader has performed Full ASCII character conversion and checked and stripped check character.
	Example: A Full ASCII bar code with check character W, A+I+MI+DW , is transmitted as J A7AIMID where 7 = (3+4).	
Trioptic Code 39	0	No option specified at this time. Always transmit 0.
	Example: A Trioptic bar code 412356 is transmitted as J X0412356	
Code 128	0	Standard data packet, no Function code 1 in first symbol position.
	1	Function code 1 in first symbol character position.
	2	Function code 1 in second symbol character position.
	Example: A Code (EAN) 128 bar code with Function 1 character ^{FNC1} in the first position, AIMID is transmitted as J C1AIMID	
I 2 of 5	0	No check digit processing.
	1	Reader has validated check digit.
	3	Reader has validated and stripped check digit.
	Example: An I 2 of 5 bar code without check digit, 4123, is transmitted as J I04123	
Codabar	0	No check digit processing.
	1	Reader has checked check digit.
	3	Reader has stripped check digit before transmission.
	Example: A Codabar bar code without check digit, 4123, is transmitted as J F04123	

Table 31 Modifier Characters (Continued)

Code Type	Option Value	Option
Code 93	0	No options specified at this time. Always transmit 0.
	Example: A Code 93 bar code 012345678905 is transmitted as JG00 12345678905	
MSI	0	Check digits are sent.
	1	No check digit is sent.
	Example: An MSI bar code 4123, with a single check digit checked, is transmitted as JM1 4123	
D 2 of 5	0	No options specified at this time. Always transmit 0.
	Example: A D 2 of 5 bar code 4123, is transmitted as JS0 4123	
UPC/EAN	0	Standard data packet in full EAN format, i.e. 13 digits for UPC-A, UPC-E, and EAN-13 (not including supplemental data).
	1	Two digit supplemental data only.
	2	Five digit supplemental data only.
	3	Combined data packet comprising 13 digits from EAN-13, UPC-A or UPC-E symbol and 2 or 5 digits from supplemental symbol.
	4	EAN-8 data packet.
	Example: A UPC-A bar code 012345678905 is transmitted as JE000 12345678905	
Bookland EAN	0	No options specified at this time. Always transmit 0.
	Example: A Bookland EAN bar code 123456789X is transmitted as JX0 123456789X	
Code 11	0	Single check digit
	1	Two check digits
	3	Check characters validated but not transmitted.
GS1 DataBar Family		No option specified at this time. Always transmit 0. GS1 DataBar-14 and GS1 DataBar Limited transmit with an Application Identifier "01". Note: In GS1-128 emulation mode, GS1 DataBar is transmitted using Code 128 rules (i.e., J C1).
	Example: A GS1 DataBar-14 bar code 100123456788902 is transmitted as Je00 1100123456788902.	

Table 31 Modifier Characters (Continued)

Code Type	Option Value	Option
EAN.UCC Composites (GS1 DataBar, GS1-128, 2D portion of UPC composite)		Native mode transmission. Note: UPC portion of composite is transmitted using UPC rules.
	0	Standard data packet.
	1	Data packet containing the data following an encoded symbol separator character.
	2	Data packet containing the data following an escape mechanism character. The data packet does not support the ECI protocol.
	3	Data packet containing the data following an escape mechanism character. The data packet supports the ECI protocol.
		GS1-128 emulation Note: UPC portion of composite is transmitted using UPC rules.
	1	Data packet is a GS1-128 symbol (i.e., data is preceded with]JC1).
PDF417, Micro PDF417	0	Reader set to conform to protocol defined in 1994 PDF417 symbology specifications. Note: When this option is transmitted, the receiver cannot reliably determine whether ECIs have been invoked or whether data byte 92 _{DEC} has been doubled in transmission.
	1	Reader set to follow the ECI protocol (Extended Channel Interpretation). All data characters 92 _{DEC} are doubled.
	2	Reader set for Basic Channel operation (no escape character transmission protocol). Data characters 92 _{DEC} are not doubled. Note: When decoders are set to this mode, unbuffered Macro symbols and symbols requiring the decoder to convey ECI escape sequences cannot be transmitted.
	3	The bar code contains a GS1-128 symbol, and the first codeword is 903-907, 912, 914, 915.
	4	The bar code contains a GS1-128 symbol, and the first codeword is in the range 908-909.
	5	The bar code contains a GS1-128 symbol, and the first codeword is in the range 910-911.
	Example: A PDF417 bar code ABCD, with no transmission protocol enabled, is transmitted as]L2ABCD.	
Data Matrix	0	ECC 000-140, not supported.
	1	ECC 200.
	2	ECC 200, FNC1 in first or fifth position.
	3	ECC 200, FNC1 in second or sixth position.
	4	ECC 200, ECI protocol implemented.
	5	ECC 200, FNC1 in first or fifth position, ECI protocol implemented.
	6	ECC 200, FNC1 in second or sixth position, ECI protocol implemented.

Table 31 Modifier Characters (Continued)

Code Type	Option Value	Option
MaxiCode	0	Symbol in Mode 4 or 5.
	1	Symbol in Mode 2 or 3.
	2	Symbol in Mode 4 or 5, ECI protocol implemented.
	3	Symbol in Mode 2 or 3, ECI protocol implemented in secondary message.
QR Code	0	Model 1 symbol.
	1	Model 2 / MicroQR symbol, ECI protocol not implemented.
	2	Model 2 symbol, ECI protocol implemented.
	3	Model 2 symbol, ECI protocol not implemented, FNC1 implied in first position.
	4	Model 2 symbol, ECI protocol implemented, FNC1 implied in first position.
	5	Model 2 symbol, ECI protocol not implemented, FNC1 implied in second position.
	6	Model 2 symbol, ECI protocol implemented, FNC1 implied in second position.
Aztec	0	Aztec symbol.
	C	Aztec Rune symbol.

Alphanumeric and Numeric Bar Codes

Numeric Bar Codes

For parameters requiring specific numeric values, scan the appropriately numbered bar code(s).



Numeric Bar Codes (continued)



Cancel

To correct an error or change a selection, scan the bar code below.



Alphanumeric Bar Codes



Space

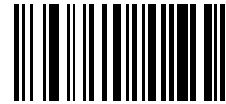

#

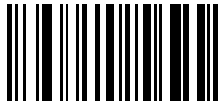

\$

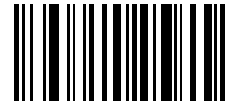

%

Alphanumeric Keyboard (continued)



*



+



-

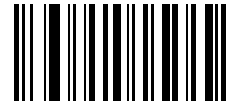

.



/

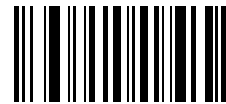

!

Alphanumeric Keyboard (continued)



“



&



€



(



)



:

Alphanumeric Keyboard (continued)



;

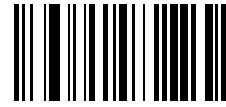

<

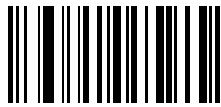

=

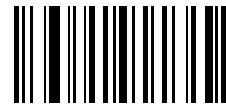

>



?

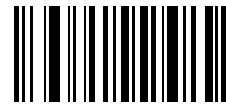

@

Alphanumeric Keyboard (continued)

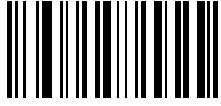

[

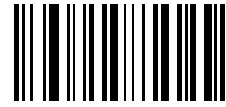

\



]



^

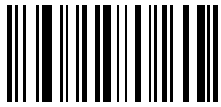

-

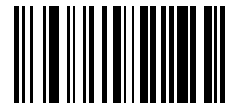

,

Alphanumeric Keyboard (continued)

✓ **NOTE:** The bar codes that follow should not be confused with those on the numeric keypad.



0



1

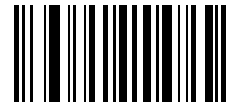

2



3



4



5

Alphanumeric Keyboard (continued)



6

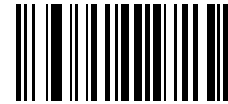

7



8



9



End of Message



Cancel

Alphanumeric Keyboard (continued)



A

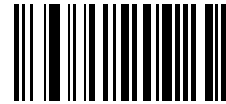

B



C

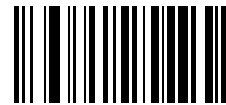

D

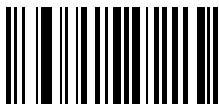

E

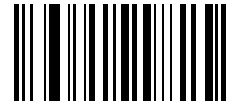

F

Alphanumeric Keyboard (continued)



G

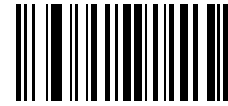

H



I

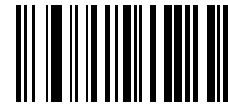

J



K

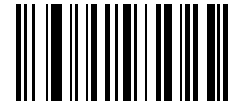

L

Alphanumeric Keyboard (continued)



M

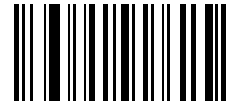

N



O

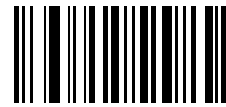

P

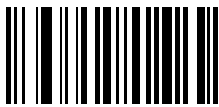

Q

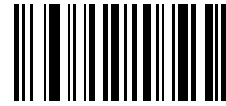

R

Alphanumeric Keyboard (continued)

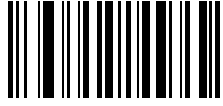

S

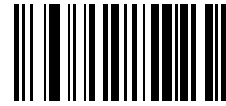

T



U



V



W

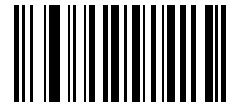

X

Alphanumeric Keyboard (continued)



Y

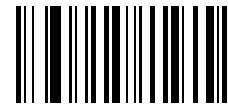

Z

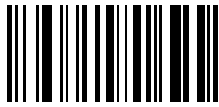

a



b



c



d

Alphanumeric Keyboard (continued)

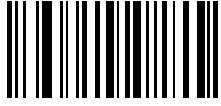

e



f



g

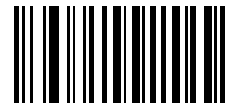

h



i



j

Alphanumeric Keyboard (continued)



k

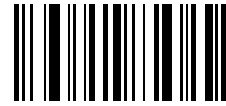

l



m



n



o

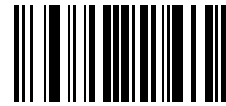

p

Alphanumeric Keyboard (continued)

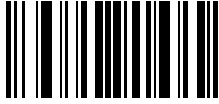

q

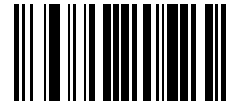

r



s

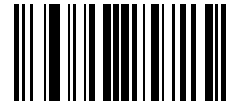

t

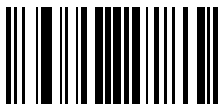

u



v

Alphanumeric Keyboard (continued)

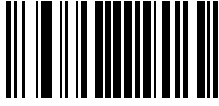

w

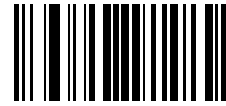

x



y

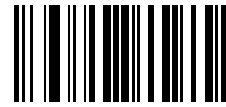

z

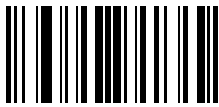

{

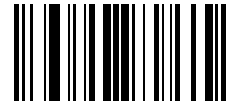

|

Alphanumeric Keyboard (continued)



}



~

Sample Bar Codes

Code 39



UPC/EAN

UPC-A, 100%



EAN-13, 100%



Code 128



12345678901234567890123456789012345678901234

Interleaved 2 of 5



GS1 DataBar-14



NOTE: DataBar-14 must be enabled to read the bar code below.



7612341562341

PDF417

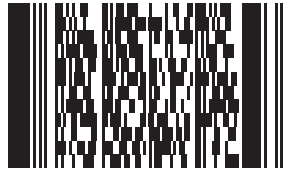

Data Matrix



Maxicode

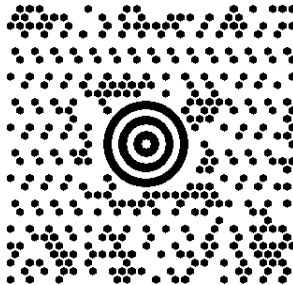

QR Code



US Postnet



UK Postal



Country Codes

Introduction

This chapter provides instructions for configuring the keyboard when the RS6000 is operating in Bluetooth HID mode.

To select a code page for the country keyboard type, see [Country Keyboard Types \(Country Codes\)](#).

Throughout the programming bar code menus, default values are indicated with asterisks (*).

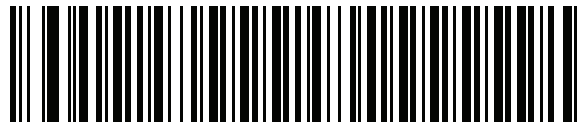

*Indicates Default — *US English (North American) — Feature/Option

Country Keyboard Types (Country Codes)

Scan the bar code corresponding to the keyboard type. This setting applies only to the Bluetooth Keyboard (HID) device.



NOTE: For best results when using international keyboards, enable [Quick Keypad Emulation on page 38](#).



IMPORTANT: Some country keyboard bar code types are specific to certain Windows Operating Systems (i.e., XP, and Win 7 or higher). Bar codes requiring a specific Windows OS are noted so in their bar code captions.

Use the **French International** bar code for Belgian French keyboards.

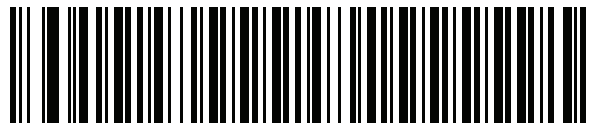

***US English (North American)**

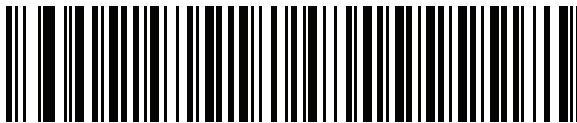

US English (Mac)



Albanian



Arabic (101)



Arabic (102)



Arabic (102) AZERTY

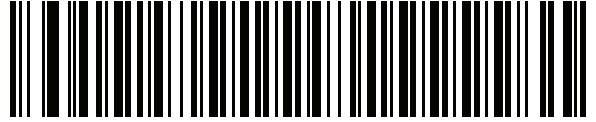

Azeri (Latin)

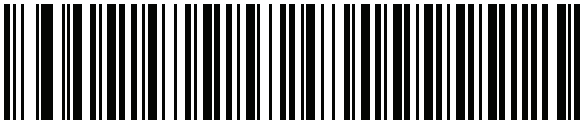

Azeri (Cyrillic)

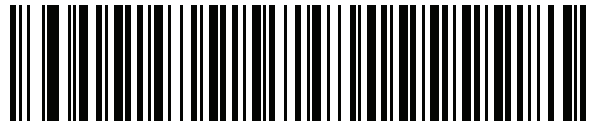

Belarusian

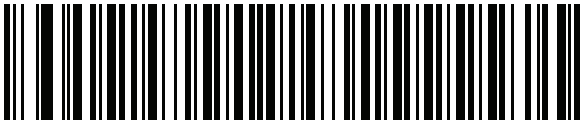

Bosnian (Latin)

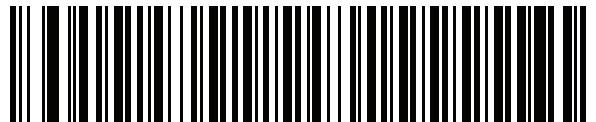

Bosnian (Cyrillic)



Bulgarian (Latin)

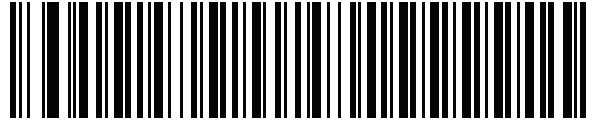

**Bulgarian Cyrillic (Typewriter)
(Bulgarian -Windows XP
Typewriter - Win 7 or higher)**

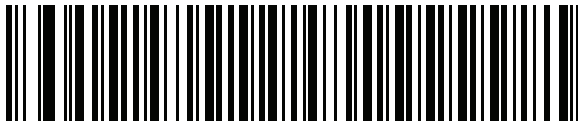

Canadian French Win7



Canadian French (Legacy)

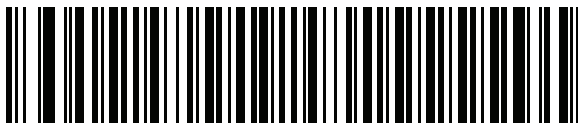

Canadian Multilingual Standard



Chinese (ASCII)

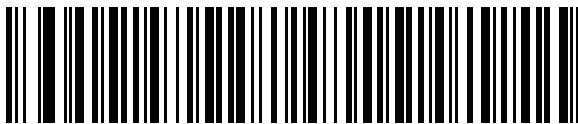

Chinese (Simplified)*



Chinese (Traditional)*

*For CJK keyboard types, see [CKJ Decode Control](#).

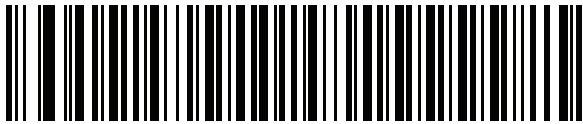

Croatian



Czech

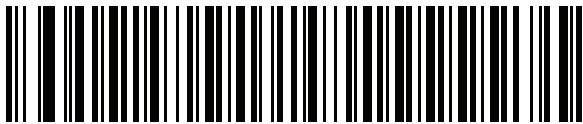

Czech (Programmer)



Czech (QWERTY)



Danish



Dutch (Netherlands)

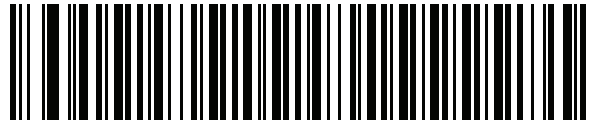

Estonian

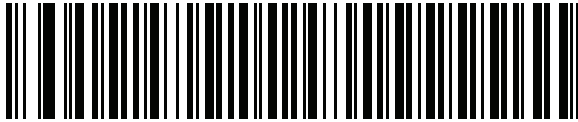

Faeroese

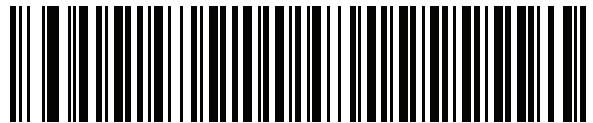

Finnish

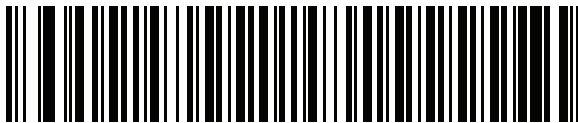

French (France)

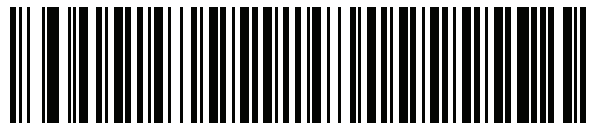

**French International
(Belgian French)**



French (Canada) 95/98



French (Canada) 2000/XP*

Country Codes

*Note that there is also a country code bar code for [Canadian Multilingual Standard on page 354](#). Be sure to select the appropriate bar code for your host system.

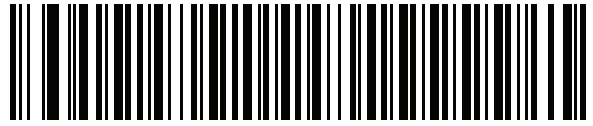

Galician

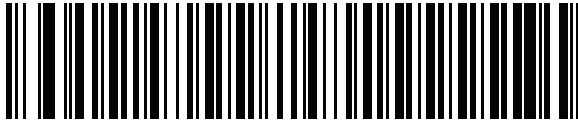

German



Greek Latin

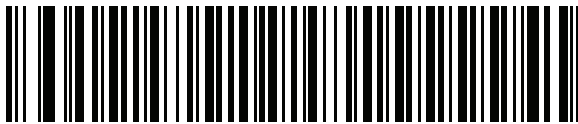

Greek (220) Latin



Greek (319) Latin



Greek



Greek (220)

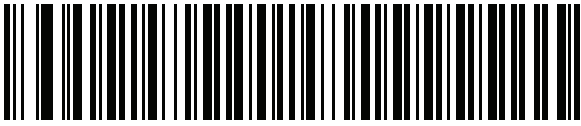

Greek (319)

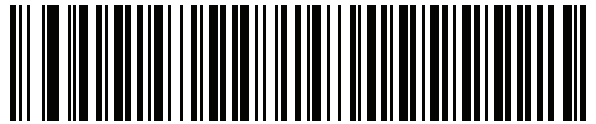

Greek Polytonic

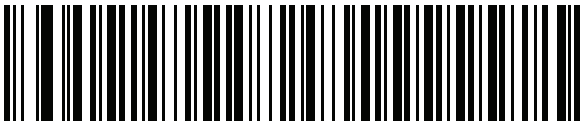

Hebrew Israel

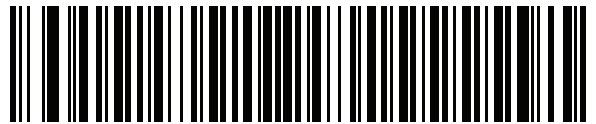

Hungarian



Hungarian_101KEY



Icelandic



Irish

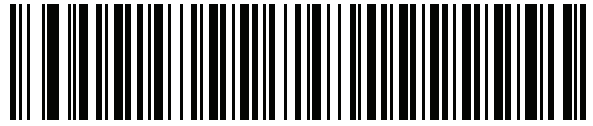

Italian

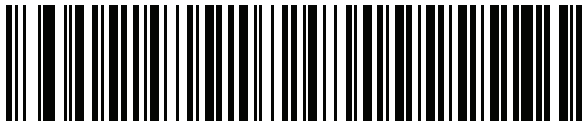

Italian (142)

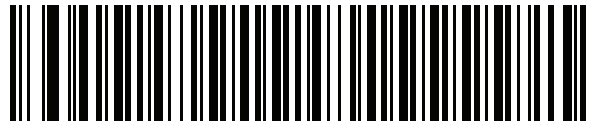

Japanese (ASCII)

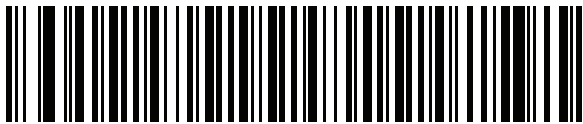

Japanese (SHIFT-JIS)*

*For CJK keyboard types, see [CJK Decode Control](#).



Kazakh



Korean (ASCII)



Korean (Hangul)*

Country Codes

*For CJK keyboard types, see [CJK Decode Control](#).

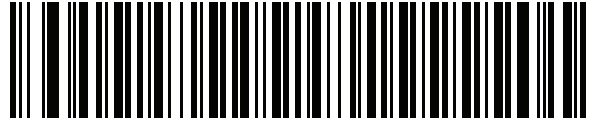

Kyrgyz

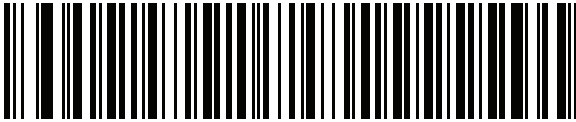

Latin American

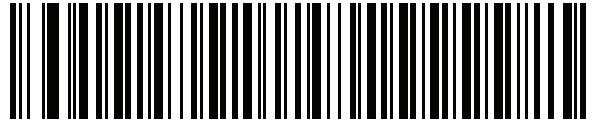

Latvian

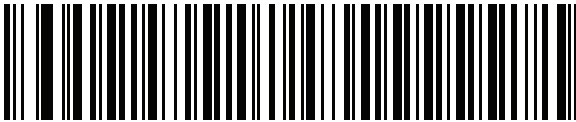

Latvian (QWERTY)

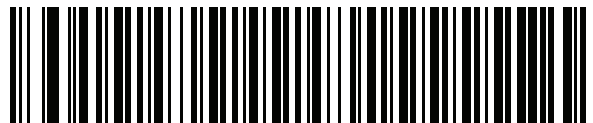

Lithuanian



Lithuanian (IBM)



Macedonian (FYROM)

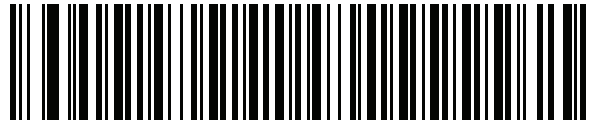

Maltese_47KEY

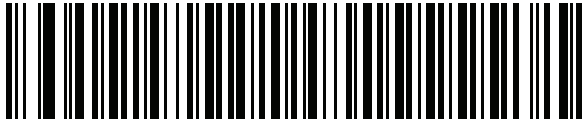

Mongolian

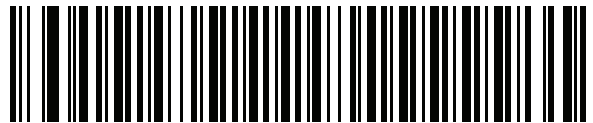

Norwegian

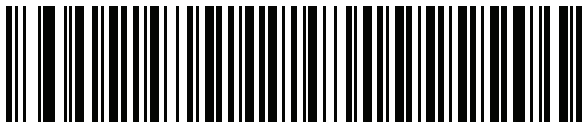

Polish (214)

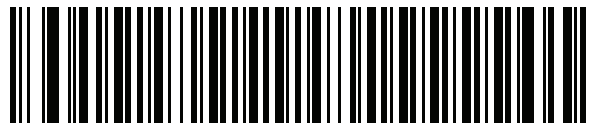

Polish (Programmer)



**Portuguese (Brazil)
(Windows XP)**



Portuguese (Brazilian ABNT)



Portuguese (Brazilian ABNT2)

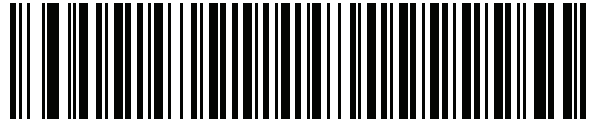

Portuguese (Portugal)

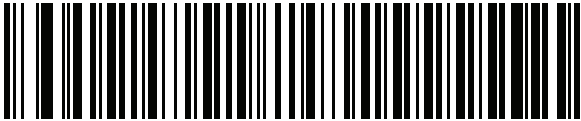

**Romanian
(Windows XP)**

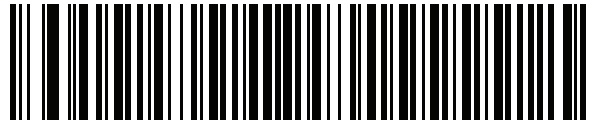

**Romanian (Legacy)
(Win 7 or higher)**

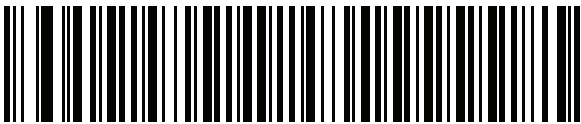

**Romanian (Standard)
(Win 7 or higher)**



**Romanian (Programmer)
(Win 7 or higher)**

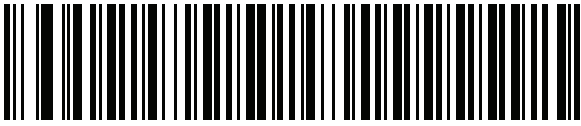

Russian

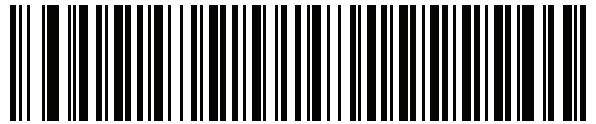

Russian (Typewriter)

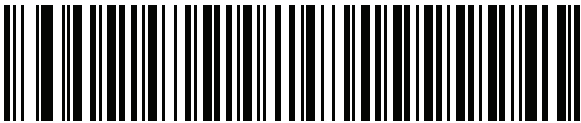

Serbian (Latin)

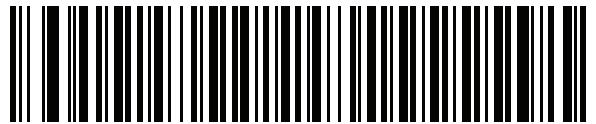

Serbian (Cyrillic)



Slovak



Slovak (QWERTY)



Slovenian

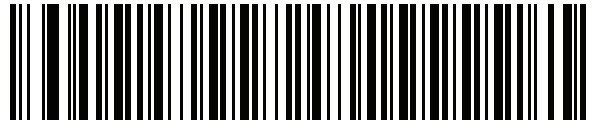

Spanish

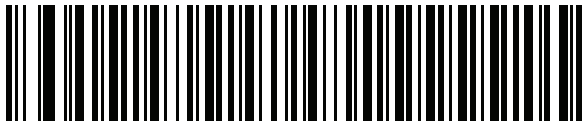

Spanish (Variation)

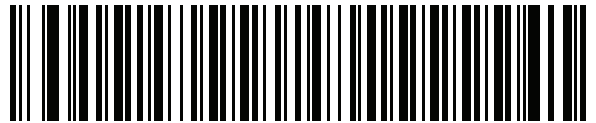

Swedish

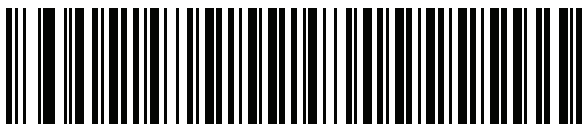

Swiss French



Swiss German



Tatar



Thai (Kedmanee)

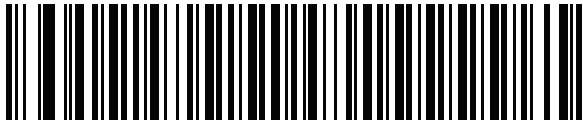

Turkish F

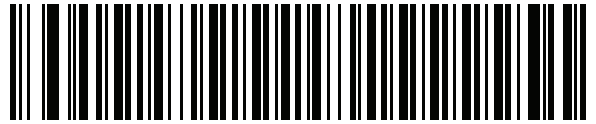

Turkish Q

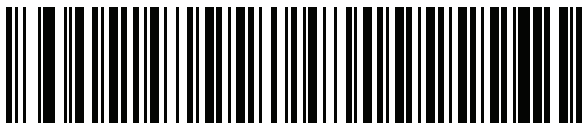

UK English

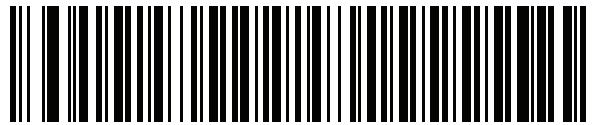

Ukrainian

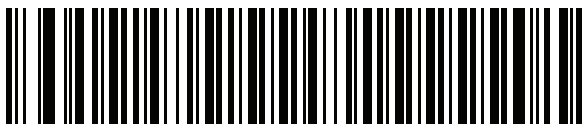

US Dvorak



US Dvorak Left



US Dvorak Right

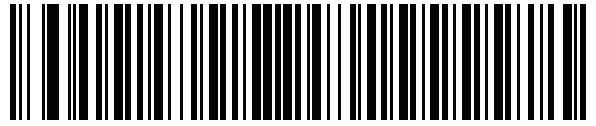

US International

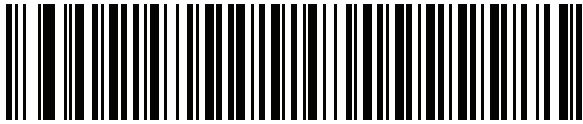

Uzbek

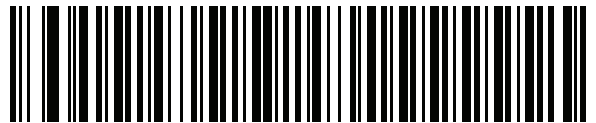

Vietnamese

Country Code Pages

Introduction

This chapter provides bar codes for selecting code pages for the country keyboard type selected in [Country Codes](#). If the default code page in [Table 32](#) is appropriate for your selected country keyboard type, you do not need to scan a country code page bar code.

✓ **NOTE:** ADF rules can also specify a code page based on the symbology and other ADF criteria. Refer to the [Advanced Data Formatting Programmer Guide](#).

Country Code Page Defaults

[Table 32](#) lists the code page default for each country keyboard.

Table 32 Country Code Page Defaults

Country Keyboard	Code Page Default
US English (North American)	Windows 1252
US English (Mac)	Mac CP10000
Albanian	Windows 1250
Arabic 101	Windows 1256
Arabic 102	Windows 1256
Arabic 102 AZERTY	Windows 1256
Azeri Latin	Windows 1254
Azeri Cyrillic	Windows 1251
Belarusian	Windows 1251
Bosnian Latin	Windows 1250
Bosnian Cyrillic	Windows 1251
Bulgarian Latin	Windows 1250
Bulgarian Cyrillic	Windows 1251

Table 32 Country Code Page Defaults

Country Keyboard	Code Page Default
Canadian French Win7	Windows 1252
Canadian French (Legacy)	Windows 1252
Canadian Multilingual	Windows 1252
Croatian	Windows 1250
Chinese ASCII	Windows 1252
Chinese (Simplified)	Windows 936, GBK
Chinese (Traditional)	Windows 950, Big5
Czech	Windows 1250
Czech Programmers	Windows 1250
Czech QWERTY	Windows 1250
Danish	Windows 1252
Dutch Netherland	Windows 1252
Estonian	Windows 1257
Faeroese	Windows 1252
Finnish	Windows 1252
French (France)	Windows 1252
French (Canada) 95/98	Windows 1252
French (Canada) 2000/XP	Windows 1252
French International (Belgian French)	Windows 1252
Galician	Windows 1252
German	Windows 1252
Greek Latin	Windows 1252
Greek220 Latin	Windows 1253
Greek319 Latin	Windows 1252
Greek	Windows 1253
Greek220	Windows 1253
Greek319	Windows 1253
Greek Polytonic	Windows 1253
Hebrew Israel	Windows 1255
Hungarian	Windows 1250
Hungarian_101KEY	Windows 1250

Table 32 Country Code Page Defaults

Country Keyboard	Code Page Default
Icelandic	Windows 1252
Irish	Windows 1252
Italian	Windows 1252
Italian_142	Windows 1252
Japanese ASCII	Windows 1252
Japanese (Shift-JIS)	Windows 932, Shift-JIS
Kazakh	Windows 1251
Korean ASCII	Windows 1252
Korean (Hangul)	Windows 949, Hangul
Kyrgyz Cyrillic	Windows 1251
Latin America	Windows 1252
Latvian	Windows 1257
Latvian QWERTY	Windows 1257
Lithuanian	Windows 1257
Lithuanian_IBM	Windows 1257
Macedonian -FYROM	Windows 1251
Maltese_47KEY	Windows 1252
Mongolian-Cyrillic	Windows 1251
Norwegian	Windows 1252
Polish_214	Windows 1250
Polish Programmer	Windows 1250
Portuguese Brazil	Windows 1252
Portuguese Brazilian ABNT	Windows 1252
Portuguese Brazilian ABNT2	Windows 1252
Portuguese Portugal	Windows 1252
Romanian	Windows 1250
Romanian Legacy	Windows 1250
Romanian Standard	Windows 1250
Romanian Programmer	Windows 1250
Russian	Windows 1251
Russian Typewriter	Windows 1251

Table 32 Country Code Page Defaults

Country Keyboard	Code Page Default
Serbian Latin	Windows 1250
Serbian Cyrillic	Windows 1251
Slovak	Windows 1250
Slovak QWERTY	Windows 1250
Slovenian	Windows 1250
Spanish	Windows 1252
Spanish Variation	Windows 1252
Swedish	Windows 1252
Swiss French	Windows 1252
Swiss German	Windows 1252
Tatar	Windows 1251
Thai-Kedmanee	Windows 874
Turkish F	Windows 1254
Turkish Q	Windows 1254
Ukrainian	Windows 1251
United Kingdom	Windows 1252
United States	Windows 1252
US Dvorak	Windows 1252
US Dvorak Left Hand	Windows 1252
US Dvorak Right Hand	Windows 1252
US International	Windows 1252
Uzbek Cyrillic	Windows 1251
Vietnamese	Windows 1258

Country Code Page Bar Codes

Scan the bar code corresponding to the country keyboard code page.



Windows 1250
Latin 2, Central European

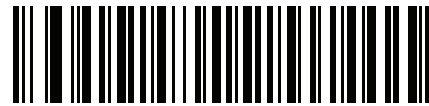

Windows 1251
Cyrillic, Slavic

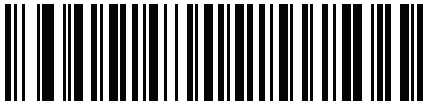

Windows 1252
Latin 1, Western European

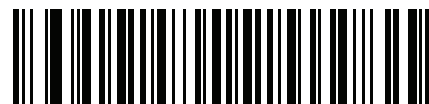

Windows 1253
Greek

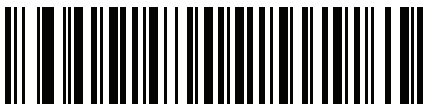

Windows 1254
Latin 5, Turkish



Windows 1255
Hebrew

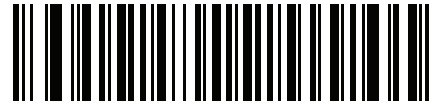

Windows 1256
Arabic



Windows 1257
Baltic

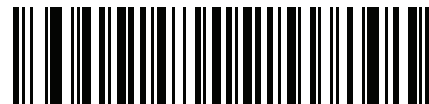

Windows 1258
Vietnamese



Windows 874
Thai

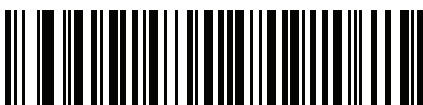

Windows 20866
Cyrillic KOI8-R



Windows 932
Japanese Shift-JIS



Windows 936
Simplified Chinese GBK



Windows 54936
Simplified Chinese GB18030

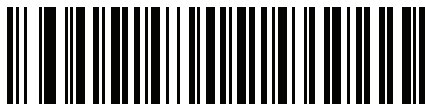

Windows 949
Korean Hangul



Windows 950
Traditional Chinese Big5

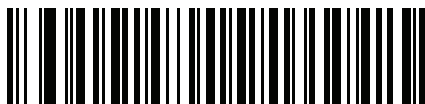

MS-DOS 437
Latin US

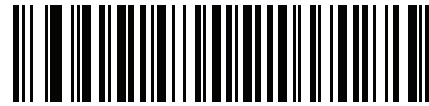

MS-DOS 737
Greek

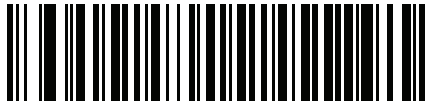

MS-DOS 775
Baltic

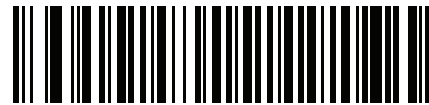

MS-DOS 850
Latin 1



MS-DOS 852
Latin 2

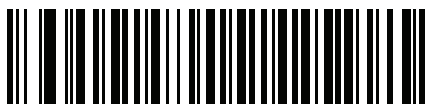

MS-DOS 855
Cyrillic



MS-DOS 857
Turkish

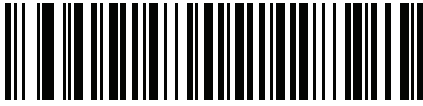

MS-DOS 860
Portuguese

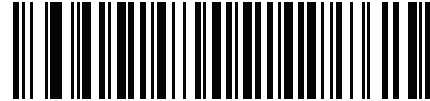

MS-DOS 861
Icelandic

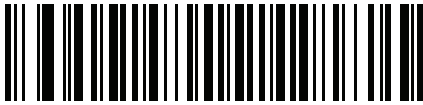

MS-DOS 862
Hebrew

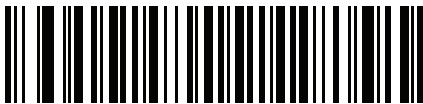

MS-DOS 863
French Canada

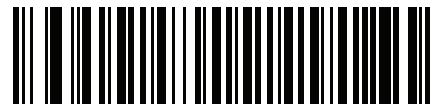

MS-DOS 865
Nordic



MS-DOS 866
Cyrillic

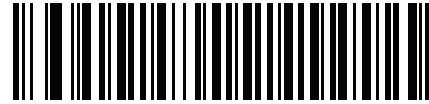

MS-DOS 869
Greek 2

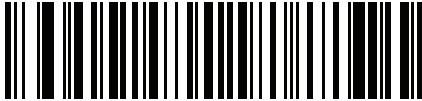

ISO 8859-1
Latin 1, Western European

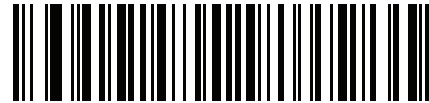

ISO 8859-2
Latin 2, Central European

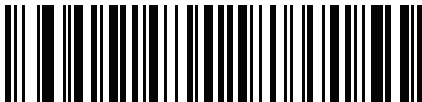

ISO 8859-3
Latin 3, South European

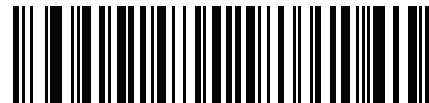

ISO 8859-4
Latin 4, North European



**ISO 8859-5
Cyrillic**



**ISO 8859-6
Arabic**

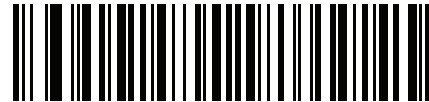

**ISO 8859-7
Greek**



**ISO 8859-8
Hebrew**

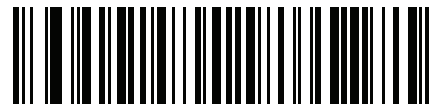

**ISO 8859-9
Latin 5, Turkish**



ISO 8859-10
Latin 6, Nordic

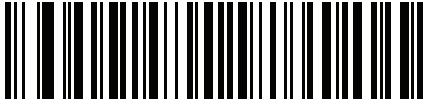

ISO 8859-11
Thai

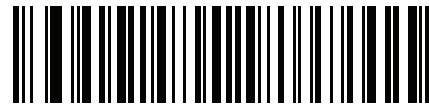

ISO 8859-13
Latin 7, Baltic



ISO 8859-14
Latin 8, Celtic

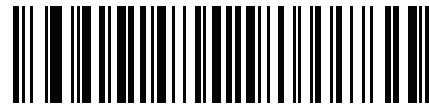

ISO 8859-15
Latin 9



ISO 8859-16
Latin 10, South-Eastern European



UTF-8



UTF-16LE
UTF-16 Little Endian

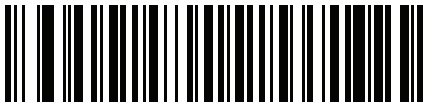

UTF-16BE
UTF-16 Big Endian

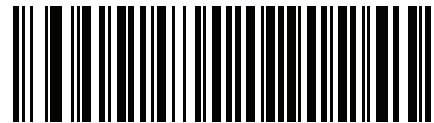

Mac CP10000
Roman

CKJ Decode Control

Introduction

This appendix describes control parameters for CJK (Chinese, Japanese, Korean) bar code decode through Bluetooth HID Keyboard Emulation mode.

- ✓ **NOTE:** Because ADF does not support CJK character processing, there is no format manipulation for CJK output.

CJK Control Parameters

Unicode Output Control

Parameter # 973

For a Unicode encoded CJK bar code, select one of the following options for unicode output:

- **Universal Output to Unicode and MBCS Application** - This default method applies to Unicode and MBCS expected applications, such as MS Word and Notepad on a Windows host.
- ✓ **NOTE:** To support Unicode universal output, set up the registry table for the Windows host. See [Unicode/CJK Decode Setup with Windows Host on page 386](#).
- **Output to Unicode Application Only** - This method applies only to Unicode expected applications, such as MS Word and WordPad, but not Notepad.



***Universal Output
(0)**

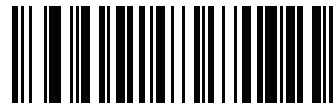

**Unicode Application Only
(1)**

CJK Output Method to Windows Host

Parameter # 972

For a national standard encoded CJK bar code, select one of the following options for CJK output to a Windows host:

- **Universal CJK Output** - This is the default universal CJK output method for US English IME or Chinese/Japanese/Korean ASCII IME on a Windows host. This method converts CJK characters to Unicode and emulates the characters when transmitting to the host. Use the [Unicode Output Control](#) parameter to control Unicode output.
- ✓ **NOTE:** To support universal CJK output, set up the registry table for the Windows host. See [Unicode/CJK Decode Setup with Windows Host on page 386](#).
- **Other options for CJK output** - With the following methods, the scanner sends the CJK character hexadecimal internal code (Nei Ma) value to host, or converts the CJK character to Unicode and sends the hexadecimal Unicode value to host. When using these methods, the Windows host must select the corresponding IME to accept the CJK character. See [Unicode/CJK Decode Setup with Windows Host on page 386](#).
 - **Japanese Unicode Output**
 - **Simplified Chinese GBK Code Output**
 - **Simplified Chinese Unicode Output**
 - **Korean Unicode Code Output**
 - **Traditional Chinese Big5 Code Output** (Windows XP)
 - **Traditional Chinese Big5 Code Output** (Windows 7)
 - **Traditional Chinese Unicode Code Output** (Windows XP)
 - **Traditional Chinese Unicode Code Output** (Windows 7)
- ✓ **NOTE:** The Unicode emulate output method depends on the host system (Windows XP or Windows 7).



*Universal CJK Output
(0)



Japanese Unicode Output
(34)

(for Japanese Unicode Output, select Simplified Chinese Unicode IME on the Windows host)

CJK Output Method to Windows Host (continued)



**Chinese (Simplified) GBK Output
(1)**

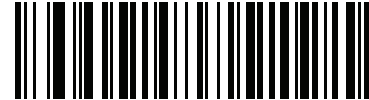

**Chinese (Simplified) Unicode Output
(2)**

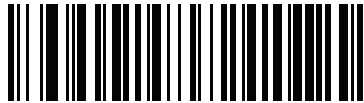

**Korean Unicode Output
(50)**

(for Korean Unicode Output, select Simplified Chinese Unicode IME on the Windows host)



**Chinese (Traditional) Big5 Output (Windows XP)
(17)**

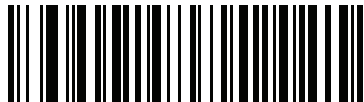

**Chinese (Traditional) Big5 Output (Windows 7)
(19)**



**Chinese (Traditional) Unicode Output (Windows XP)
(18)**



**Chinese (Traditional) Unicode Output (Windows 7)
(20)**

Non-CJK UTF Bar Code Output

Parameter # 960

Some country keyboard type layouts contain characters that do not exist in the default code page (see [Country Keyboard Type Missing Characters on page 384](#)). Although the default code page can not encode these characters in a bar code, they can be encoded in the UTF-8 bar code. Scan this parameter bar code to output the Unicode values by emulation mode.

- ✓ **NOTE:** Use this special country keyboard type to decode the non-CJK UTF-8 bar code. After decoding, re-configure the scanner to use the original country keyboard type.

Use US English IME on Windows. See [Unicode Output Control on page 381](#).



Non-CJK UTF-8 Emulation Output

Country Keyboard Type Missing Characters

Country keyboard type: **Tatar, Uzbek, Mongolian, Kyrgyz, Kazakh and Azeri**

Default code page: CP1251

Missing characters:

Table 33

ƒ	F
χ	Χ
κ	Κ
h	h
ϑ	Θ
ϑ	Θ
γ	Υ
н	Н
ж	Ж
ƒ	
н	Н
Ƴ	Ƴ
κ	Κ

Table 33

ı	ı
ƙ	ƙ

Country keyboard type: **Romanian (Standard)**

Default code page: CP1250

Missing characters:

Table 34

ş	Ş
ţ	Ț

Country keyboard type: **Portuguese-Brazilian (ABNT), Portuguese-Brazilian (ABNT2)**

Default code page: CP1252

Missing character: 

Country keyboard type: **Azeri-Latin**

Default code page: CP1254

Missing characters: ə , Ə

Unicode/CJK Decode Setup with Windows Host

This section describes how to set up CJK decode with a Windows host.

Setting Up the Windows Registry Table for Unicode Universal Output

To support the Unicode universal output method, set up the Windows host registry table as follows:

1. Select **Start > Run > regedt32** to start the registry editor.
2. Under **HKEY_Current_User\Control Panel\Input Method**, set **EnableHexNumpad** to **1** as follows:

```
[HKEY_CURRENT_USER\Control Panel\Input Method]
```

```
"EnableHexNumpad"="1"
```

If this key does not exist, add it as type **REG_SZ** (string value).

3. Reboot the computer to implement the registry change.

Adding CJK IME on Windows

To add the desired CJK input language:

1. Click **Start > Control Panel**.
2. If the Control Panel opens in category view, select **Switch to Classic View** in the top left corner.
3. Select **Regional and Language Options**.
4. Click the **Language** tab.
5. Under **Supplemental Language Support**, select the **Install Files for East Asian Languages** check box if not already selected, and click **Apply**. This may require a Windows installation CD to install the required files. This step ensures that the East Asian Languages (CJK) are available.
6. Under **Text Services and Input Language**, click **Details**.
7. Under **Installed Services**, click **Add**.
8. In the **Add Input Language** dialog box, choose the CJK input language and keyboard layout or Input Method Editor (IME) to add.
9. Click **OK** twice. The language indicator appears in the system tray (at bottom right corner of the desktop by default). To switch between input languages (keyboard languages) select the language indicator in the system tray.
10. Select the language indicator in the system tray to select the desired country keyboard type.
11. Verify that the characters displayed on each country's keyboard appear.

Selecting the Simplified Chinese Input Method on the Host

To select the Simplified Chinese input method:

- Select Unicode/GBK input on Windows XP: **Chinese (Simplified) - NeiMa**, then click the input bar to select **Unicode** or **GBK NeiMa** input.

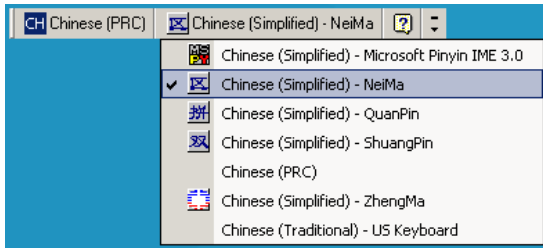

Or



- Select Unicode/GBK input on Windows7: **Chinese (Simplified) - Microsoft Pinyin New Experience Input Style**, then select **Tool Menu > Secondary Inputs > Unicode Input** or **GB Code Input**.

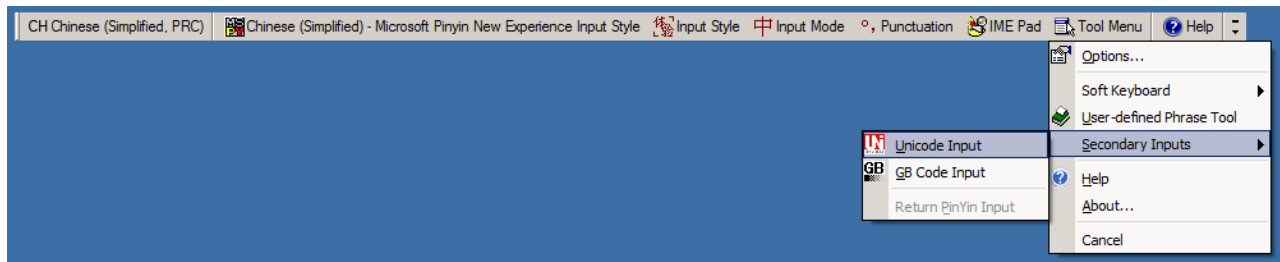

Selecting the Traditional Chinese Input Method on the Host

To select the Traditional Chinese input method:

- Select Unicode input on Windows XP: **Chinese (Traditional) - Unicode**

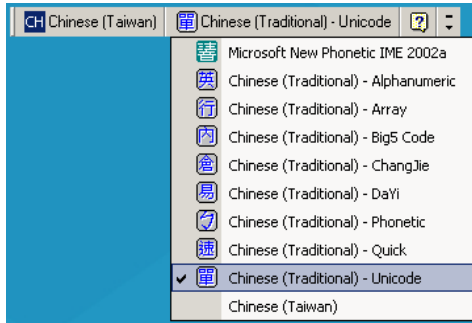

- Select Big5 input on Windows XP: **Chinese (Traditional) - Big5 Code**

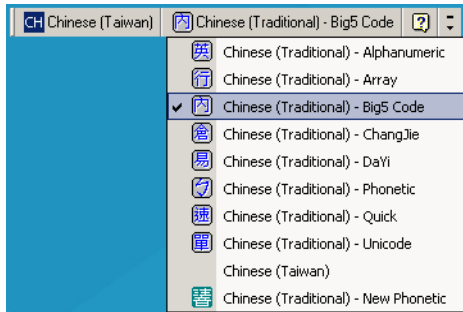

- Select Unicode/Big5 input on Windows 7: **Chinese (Traditional) - New Quick**. This option support both Unicode and Big5 input.



ASCII Character Sets

Table 35 ASCII Value Table

ASCII Value	Full ASCII Code 39 Encode Char	Keystroke
1000	%U	CTRL 2
1001	\$A	CTRL A
1002	\$B	CTRL B
1003	\$C	CTRL C
1004	\$D	CTRL D
1005	\$E	CTRL E
1006	\$F	CTRL F
1007	\$G	CTRL G
1008	\$H	CTRL H/ BACKSPACE ¹
1009	\$I	CTRL I/ HORIZONTAL TAB ¹
1010	\$J	CTRL J
1011	\$K	CTRL K
1012	\$L	CTRL L
1013	\$M	CTRL M/ ENTER ¹
1014	\$N	CTRL N
1015	\$O	CTRL O
1016	\$P	CTRL P
1017	\$Q	CTRL Q
1018	\$R	CTRL R
1019	\$S	CTRL S

The keystroke in bold transmits only if you enabled Function Key Mapping. Otherwise, the unbold keystroke transmits.

Table 35 ASCII Value Table (Continued)

ASCII Value	Full ASCII Code 39 Encode Char	Keystroke
1020	\$T	CTRL T
1021	\$U	CTRL U
1022	\$V	CTRL V
1023	\$W	CTRL W
1024	\$X	CTRL X
1025	\$Y	CTRL Y
1026	\$Z	CTRL Z
1027	%A	CTRL [
1028	%B	CTRL \
1029	%C	CTRL]
1030	%D	CTRL 6
1031	%E	CTRL -
1032	Space	Space
1033	/A	!
1034	/B	"
1035	/C	#
1036	/D	\$
1037	/E	%
1038	/F	&
1039	/G	'
1040	/H	(
1041	/I)
1042	/J	*
1043	/K	+
1044	/L	,
1045	-	-
1046	.	.
1047	/o	/
1048	0	0

The keystroke in bold transmits only if you enabled Function Key Mapping. Otherwise, the unbold keystroke transmits.

Table 35 ASCII Value Table (Continued)

ASCII Value	Full ASCII Code 39 Encode Char	Keystroke
1049	1	1
1050	2	2
1051	3	3
1052	4	4
1053	5	5
1054	6	6
1055	7	7
1056	8	8
1057	9	9
1058	/Z	:
1059	%F	;
1060	%G	<
1061	%H	=
1062	%I	>
1063	%J	?
1064	%V	@
1065	A	A
1066	B	B
1067	C	C
1068	D	D
1069	E	E
1070	F	F
1071	G	G
1072	H	H
1073	I	I
1074	J	J
1075	K	K
1076	L	L
1077	M	M

The keystroke in bold transmits only if you enabled Function Key Mapping. Otherwise, the unbold keystroke transmits.

Table 35 ASCII Value Table (Continued)

ASCII Value	Full ASCII Code 39 Encode Char	Keystroke
1078	N	N
1079	O	O
1080	P	P
1081	Q	Q
1082	R	R
1083	S	S
1084	T	T
1085	U	U
1086	V	V
1087	W	W
1088	X	X
1089	Y	Y
1090	Z	Z
1091	%K	[
1092	%L	\
1093	%M]
1094	%N	^
1095	%O	_
1096	%W	'
1097	+A	a
1098	+B	b
1099	+C	c
1100	+D	d
1101	+E	e
1102	+F	f
1103	+G	g
1104	+H	h
1105	+I	i
1106	+J	j

The keystroke in bold transmits only if you enabled Function Key Mapping. Otherwise, the unbold keystroke transmits.

Table 35 ASCII Value Table (Continued)

ASCII Value	Full ASCII Code 39 Encode Char	Keystroke
1107	+K	k
1108	+L	l
1109	+M	m
1110	+N	n
1111	+O	o
1112	+P	p
1113	+Q	q
1114	+R	r
1115	+S	s
1116	+T	t
1117	+U	u
1118	+V	v
1119	+W	w
1120	+X	x
1121	+Y	y
1122	+Z	z
1123	%P	{
1124	%Q	
1125	%R	}
1126	%S	~

The keystroke in bold transmits only if you enabled Function Key Mapping. Otherwise, the unbold keystroke transmits.

Table 36 ALT Key Standard Default Tables

ALT Keys	Keystroke
2064	ALT 2
2065	ALT A
2066	ALT B
2067	ALT C
2068	ALT D

Table 36 ALT Key Standard Default Tables (Continued)

ALT Keys	Keystroke
2069	ALT E
2070	ALT F
2071	ALT G
2072	ALT H
2073	ALT I
2074	ALT J
2075	ALT K
2076	ALT L
2077	ALT M
2078	ALT N
2079	ALT O
2080	ALT P
2081	ALT Q
2082	ALT R
2083	ALT S
2084	ALT T
2085	ALT U
2086	ALT V
2087	ALT W
2088	ALT X
2089	ALT Y
2090	ALT Z

Table 37 USB GUI Key Character Set

GUI Key	Keystroke
3000	Right Control Key
3048	GUI 0
3049	GUI 1
3050	GUI 2

Note: GUI Shift Keys - The Apple™ iMac keyboard has an apple key on either side of the space bar. Windows-based systems have a GUI key to the left of the left ALT key, and to the right of the right ALT key.

Table 37 USB GUI Key Character Set (Continued)

GUI Key	Keystroke
3051	GUI 3
3052	GUI 4
3053	GUI 5
3054	GUI 6
3055	GUI 7
3056	GUI 8
3057	GUI 9
3065	GUI A
3066	GUI B
3067	GUI C
3068	GUI D
3069	GUI E
3070	GUI F
3071	GUI G
3072	GUI H
3073	GUI I
3074	GUI J
3075	GUI K
3076	GUI L
3077	GUI M
3078	GUI N
3079	GUI O
3080	GUI P
3081	GUI Q
3082	GUI R
3083	GUI S
3084	GUI T
3085	GUI U
3086	GUI V
3087	GUI W

Note: GUI Shift Keys - The Apple™ iMac keyboard has an apple key on either side of the space bar. Windows-based systems have a GUI key to the left of the left ALT key, and to the right of the right ALT key.

Table 37 USB GUI Key Character Set (Continued)

GUI Key	Keystroke
3088	GUI X
3089	GUI Y
3090	GUI Z

Note: GUI Shift Keys - The Apple™ iMac keyboard has an apple key on either side of the space bar. Windows-based systems have a GUI key to the left of the left ALT key, and to the right of the right ALT key.

Table 38 PF Key Standard Default Table

PF Keys	Keystroke
4001	PF 1
4002	PF 2
4003	PF 3
4004	PF 4
4005	PF 5
4006	PF 6
4007	PF 7
4008	PF 8
4009	PF 9
4010	PF 10
4011	PF 11
4012	PF 12
4013	PF 13
4014	PF 14
4015	PF 15
4016	PF 16

Table 39 F key Standard Default Table

F Keys	Keystroke
5001	F 1
5002	F 2
5003	F 3
5004	F 4

Table 39 F key Standard Default Table (Continued)

F Keys	Keystroke
5005	F 5
5006	F 6
5007	F 7
5008	F 8
5009	F 9
5010	F 10
5011	F 11
5012	F 12
5013	F 13
5014	F 14
5015	F 15
5016	F 16
5017	F 17
5018	F 18
5019	F 19
5020	F 20
5021	F 21
5022	F 22
5023	F 23
5024	F 24

Table 40 Numeric Key Standard Default Table

Numeric Keypad	Keystroke
6042	*
6043	+
6044	Undefined
6045	-
6046	.
6047	/
6048	0
6049	1

Table 40 Numeric Key Standard Default Table (Continued)

Numeric Keypad	Keystroke
6050	2
6051	3
6052	4
6053	5
6054	6
6055	7
6056	8
6057	9
6058	Enter
6059	Num Lock

Table 41 Extended Keypad Standard Default Table

Extended Keypad	Keystroke
7001	Break
7002	Delete
7003	Pg Up
7004	End
7005	Pg Dn
7006	Pause
7007	Scroll Lock
7008	Backspace
7009	Tab
7010	Print Screen
7011	Insert
7012	Home
7013	Enter
7014	Escape
7015	Up Arrow
7016	Dn Arrow
7017	Left Arrow
7018	Right Arrow

INDEX

Numerics

123Scan	277
requirements	278
2D bar codes	
aztec	230
aztec inverse	230
code 128 emulation	225
data matrix	226
data matrix inverse	227
han xin	231
han xin inverse	231
maxicode	227
microPDF417	224
microQR	229
PDF417	224
QR code	228

A

Acceptable Aiming Options	25
accessories	81
ADF	279
advanced data formatting	279
auto-reconnect	66
auto-triggering mode	23

B

bar code defaults	
bluetooth communication	28
bar codes	
Australia post	235
Australia post format	236
auto-reconnect interval	66
aztec	230
aztec inverse	230
batch mode	79
beep after good decode	118
beep on insertion	118
beeper duration	121
beeper tone	120

beeper volume	119
Bluetooth technology support	34
bookland EAN	151
bookland ISBN	164
buffering	184, 185
cancel	329
Chinese 2 of 5	211
codabar	203
codabar CLSI editing	205
codabar lengths	203
codabar NOTIS editing	205
codabar start and stop characters	206
code 11	189
code 11 check digit verification	191
code 11 lengths	189
code 128	168
code 128 emulation	225
code 128 lengths	169
code 128 reduced quiet zone	175
code 128 security level	174
code 32 prefix	179
code 39	177
transmit buffer	186
code 39 check digit verification	181
code 39 full ASCII	182
code 39 lengths	180
code 39 reduced quiet zone	184
code 39 security level	183
code 39 transmit check digit	181
code 93	187
code 93 lengths	187
composite beep mode	223
composite CC-A/B	220
composite CC-C	220
composite TLC-39	221
continuous bar code read	127
convert code 39 to code 32	178
convert GS1 databar to UPC/EAN	218
convert UPC-E to UPC-A	162
convert UPC-E1 to UPC-A	162
country code page defaults	367
country code pages	371

country codes	352	MSI transmit check digit	209
data matrix	226	Netherlands KIX code	237
data matrix inverse	227	numeric bar codes	329
decode mirror images	131	OCR	
decode session timeout	128	check digit	269
disable all code types	148	check digit multiplier	270
discrete 2 of 5	200	check digit validation	271
discrete 2 of 5 lengths	201	default table	246
EAN zero extend	163	inverse OCR	276
EAN-13/JAN-13	151	lines	257
EAN-8/JAN-8	150	maximum characters	258
enable all code types	148	MICR E13B	254
enter	135	minimum character	257
flush macro buffer/abort macro PDF entry	245	OCR-A	248
FN1 substitution values	139	OCR-A variant	248
fuzzy 1D processing	130	OCR-B	250
GS1 databar bar codes	217	OCR-B variant	251
GS1 databar expanded	218	orientation	255
GS1 databar limited	217	parameters	248
GS1 databar limited security level	219	quiet zone	259
GS1 databar-14	217	subset	258
GS1-128	171	template	260
GS1-128 emulation mode	223	US currency serial number	255
han xin	231	parameter scanning	117
han xin inverse	231	PDF prioritization	133
I 2 of 5 check digit verification	196	PDF prioritization timeout	134
I 2 of 5 convert to EAN-13	197	PDF417	224
I 2 of 5 reduced quiet zone	199	picklist mode	125
I 2 of 5 security level	198	postal	232
I 2 of 5 transmit check digit	197	prefix/suffix values	136
ignore code 128 fnc4	175	QR code	228
illumination	134	quiet zone level	243
intercharacter gap size	244	reconnect attempt beep	67
interleaved 2 of 5	193	reconnect attempt interval	68
convert to EAN-13	197, 198	redundancy level	240
interleaved 2 of 5 lengths	194	report version	244
inverse 1D	216	samples	347
ISBT 128	171	scan data options	137
ISBT concatenation	172, 173	security level	242
ISBT concatenation redundancy	173	set defaults	116
ISSN EAN	167	suppress power up beeps	121
Japan postal	234	symbolologies	
Korean 3 of 5	215	default table	142
matrix 2 of 5	212	timeout between decodes, different symbols	130
matrix 2 of 5 check digit	214	timeout between decodes, same symbol	129
matrix 2 of 5 lengths	212, 213	transmit code 11 check digits	192
maxicode	227	transmit code ID character	135
microPDF417	224	transmit matrix 2 of 5 check digit	214
microQR	229	transmit no read message	140
mobile phone/display mode	132	transmit UK postal check digit	234
motion tolerance	135	transmit US postal check digit	233
MSI	207	trigger mode	123
MSI check digit algorithm	210	trioptic code 39	177
MSI check digits	209	UCC coupon extended code	165
MSI lengths	207	UK postal	233

- unicode output control 381
 - unique bar code reporting 127
 - unpair 78
 - UPC composite mode 222
 - UPC reduced quiet zone 157
 - UPC/EAN
 - coupon code 165
 - UPC/EAN supplemental AIM ID format 156
 - UPC/EAN supplemental redundancy 155
 - UPC/EAN supplementals 152
 - UPC-A 149
 - UPC-A check digit 157
 - UPC-A preamble 159
 - UPC-E 149
 - UPC-E check digit 158
 - UPC-E preamble 160
 - UPC-E1 150
 - UPC-E1 check digit 158
 - UPC-E1 preamble 161
 - UPU FICS postal 238
 - US planet 232
 - US postnet 232
 - USB
 - country keyboard types (country codes) 352
 - USPS 4CB/One Code/Intelligent Mail 237
 - variable PIN code 59
 - wi-fi friendly mode 61
 - batch mode stored data 79
 - battery
 - charging 21
 - Battery Release 22
 - Bluetooth
 - encryption 60
 - HID 34
 - pin code 58
 - secure simple pairing IO capability 60
 - SPP 66
 - bluetooth communication
 - defaults 28
 - bright center dot 24
 - bullets 15
- C**
- charging batteries 21
 - Chinese 2 of 5 bar codes 211
 - CJK 380
 - codabar bar codes 203
 - CLSI editing 205
 - lengths 203
 - NOTIS editing 205
 - start and stop characters 206
 - code 11 bar codes 189
 - check digit verification 191
 - lengths 189
 - transmit check digit 192
 - code 128 bar codes 168
 - GS1-128 171
 - ignore fnc4 175
 - ISBT 128 171
 - ISBT concatenation 172, 173
 - ISBT concatenation redundancy 173
 - lengths 169
 - reduced quiet zone 175
 - security level 174
 - code 128 emulation bar codes 225
 - code 39 bar codes 177
 - buffering 184, 185
 - check digit verification 181
 - code 32 prefix 179
 - code 39 177
 - code 39 security Level 183
 - convert code 39 to code 32 178
 - full ASCII 182
 - lengths 180
 - reduced quiet zone 184
 - transmit check digit 181
 - trioptic 177
 - code 93 bar codes 187
 - lengths 187
 - code ID character 135
 - code identifiers
 - AIM code IDs 323
 - modifier characters 324
 - Symbol 322
 - Cold Boot 25
 - composite bar codes
 - beep mode 223
 - composite CC-A/B 220
 - composite CC-C 220
 - composite TLC-39 221
 - GS1-128 emulation mode 223
 - UPC composite mode 222
 - conventions
 - notational 15
 - country code page defaults 367
 - country code pages 371
 - country codes 352
 - Cross Hair Lines 24
- D**
- data matrix bar codes 226
 - default parameters
 - bluetooth communication 28
 - OCR 246
 - setting 116
 - standard default table 313
 - symbolologies 142
 - discrete 2 of 5 bar codes 200

lengths	201	Danish	355
E		Dutch (Netherlands)	355
encryption	60	Estonian	356
error indications		Faeroese	356
miscellaneous scanner options	27	Finnish	356
exposure options		French (Canada) 2000/XP	356
illumination	134	French (Canada) 95/98	356
		French (France)	356
G		French International	356
getting started	21	Galician	357
GS1 databar	217	German	357
GS1 databar bar codes		Greek	357
convert GS1 databar to UPC/EAN	218	Greek (220) Latin	357
GS1 databar expanded	218	Greek (319) Latin	357
GS1 databar limited	217	Greek 220	357
GS1 databar limited security level	219	Greek 319	358
GS1 databar-14	217	Greek Latin	357
		Greek Polytonic	358
I		Hebrew Israel	358
illumination	134	Hungarian	358
information, service	16	Hungarian_101KEY	358
interleaved 2 of 5 bar codes	193	Irish	358
check digit verification	196	Islandic	358
convert to EAN-13	197	Italian	359
lengths	194	Italian (142)	359
reduced quiet zone	199	Japanese (ASCII)	359
security level	198	Kazakh	359
transmit check digit	197	Korean (ASCII)	359
		Kyrgyz	360
K		Latin American	360
keyboard types (country codes)		Latvian	360
Albanian	352	Latvian (QWERTY)	360
Arabic (101)	352	Lithuanian	360
Arabic (102)	352	Lithuanian (IBM)	360
Arabic (102) Azerty	353	Macedonian (FYROM)	360
Azeri (Cyrillic)	353	Maltese_47KEY	361
Azeri (Latin)	353	Mongolian	361
Belarusian	353	Norwegian	361
Bosnian (Cyrillic)	353	Polish (214)	361
Bosnian (Latin)	353	Polish (Programmer)	361
Bulgarian (Latin)	353	Portuguese (Brazil)	361
Bulgarian Cyrillic (Typewriter)	354	Portuguese (Brazilian ABNT)	361
Canadian French (Legacy)	354	Portuguese (Brazilian ABNT2)	362
Canadian French Win7	354	Portuguese (Portugal)	362
Canadian Multilingual Standard	354	Romanian	362
Chinese (ASCII)	354	Romanian (Legacy)	362
Croatian	355	Romanian (Programmer)	362
Czech	355	Romanian (Standard)	362
Czech (Programmer)	355	Russian	363
Czech (QWERTY)	355	Russian (Typewriter)	363
		Serbian (Cyrillic)	363
		Serbian (Latin)	363
		Slovak	363
		Slovak (QWERTY)	363
		Slovenian	363

- Spanish 364
 - Spanish (Variation) 364
 - Swedish 364
 - Swiss French 364
 - Swiss German 364
 - Tatar 364
 - Thai (Kedmanee) 364
 - Turkish F 365
 - Turkish Q 365
 - UK English 365
 - Ukrainian 365
 - US Dvorak 365
 - US Dvorak Left 365
 - US Dvorak Right 365
 - US English 352
 - US International 366
 - Uzbek 366
 - Vietnamese 366
 - Korean 3 of 5 bar codes 215
- L**
- low power mode 66
- M**
- macro PDF 245
 - flush buffer/abort PDF entry 245
 - Manual Triggering 23
 - master serial port profile 66
 - matrix 2 of 5 bar codes 212
 - check digit 214
 - lengths 212, 213
 - transmit check digit 214
 - maxicode bar codes 227
 - MDF 280
 - microPDF417 bar codes 224
 - MSI bar codes 207
 - check digit algorithm 210
 - check digits 209
 - lengths 207
 - transmit check digit 209
 - multicode data formatting 280
- O**
- OCR
 - default parameters 246
 - parameters 248
- P**
- pairing
 - bar code format 78
 - pin codes 58
 - unpair 78
 - parameter defaults
 - bluetooth communication 28
 - parameters
 - batch mode 79
 - beep on insertion 118
 - Bluetooth technology support 34
 - radio communication
 - auto-reconnect interval 66
 - batch mode 79
 - reconnect attempt beep 67
 - reconnect attempt interval 68
 - unpair 78
 - parts of the mobile computer 17
 - PDF417 bar codes 224
 - PDF prioritization 133
 - PIN code
 - static 59
 - variable 59
 - postal codes 232
 - Australia post 235
 - Australia post format 236
 - Japan postal 234
 - Netherlands KIX code 237
 - transmit UK postal check digit 234
 - transmit US postal check digit 233
 - UK postal 233
 - UPU FICS postal 238
 - US planet 232
 - US postnet 232
 - USPS 4CB/One Code/Intelligent Mail 237
 - preferred symbol 280
- Q**
- QR code bar codes 228
- R**
- radio communication
 - reconnect attempt 68
 - reconnect attempt beep 67
 - reconnect attempt 68
 - reconnect attempt beep 67
 - Resetting 25
- S**
- sample bar codes 347
 - scanner control app 279
 - scanning
 - errors 114, 141
 - radio communications sequence example 27
 - sequence example 114, 141
 - secure simple pairing IO capability 60

security		
intercharacter gap size	244	
quiet zone level	243	
redundancy level	240	
security level	242	
Serial Port Profile		
master	66	
service information	16	
setting defaults	116	
software tools		
123Scan	277	
ADF	279	
MDF	280	
preferred symbol	280	
scanner control app	279	
SPP		
master	66	
standard default parameters	313	
stored data		
batch mode	79	
Symbol Scan Orientation	24	
sympology default parameters	142	
T		
trigger mode	123	
Trigger Position	21	
Trigger Swivel Assembly	21	
U		
unicode		
output control	381	
unpacking	17	
unpairing		
bar code	78	
UPC/EAN bar codes		
bookland EAN	151	
bookland ISBN	164	
check digit	157, 158	
convert UPC-E to UPC-A	162	
convert UPC-E1 to UPC-A	162	
EAN zero extend	163	
EAN-13/JAN-13	151	
EAN-8/JAN-8	150	
ISSN EAN	167	
reduced quiet zone	157	
supplemental AIM ID format	156	
supplemental redundancy	155	
supplementals	152	
UCC coupon extended code	165	
UPC-A	149	
UPC-A preamble	159	
UPC-E	149	
UPC-E preamble	160	
UPC-E1	150	
UPC-E1 preamble	161	
user preferences bar codes		
batch mode	79	
beep on insertion	118	
W		
Warm Boot	25	
wi-fi friendly mode	61	

