



# PT30 Series

## Mobile Computer

### User Guide



## **Disclaimer**

© 2012-2016 Fujian Newland Auto-ID Tech. Co., Ltd. All rights reserved.

Please read through the manual carefully before using the product and operate it according to the manual. It is advised that you should keep this manual for future reference.

Do not disassemble the device or remove the seal label from the device, doing so will void the product warranty provided by Fujian Newland Auto-ID Tech. Co., Ltd.

All pictures in this manual are for reference only and actual product may differ. Regarding to the product modification and update, Fujian Newland Auto-ID Tech. Co., Ltd. reserves the right to make changes to any software or hardware to improve reliability, function, or design at any time without notice. The information contained herein is subject to change without prior notice.

The products depicted in this manual may include software copyrighted by Fujian Newland Auto-ID Tech. Co., Ltd or third party. The user, corporation or individual, shall not duplicate, in whole or in part, distribute, modify, decompile, disassemble, decode, reverse engineer, rent, transfer or sublicense such software without prior written consent from the copyright holders.

This manual is copyrighted. No part of this publication may be reproduced, distributed or used in any form without written permission from Newland.

## Revision History

Changes to the original manual are listed below:

Version	Description	Date
V1.0	Initial release.	2012-04-12
V1.1	Corrected improper descriptions.	2012-05-16
V1.2	Updated the figures in Chapter 6.	2012-09-24
V1.3	Updated the screenshots of the PT30.	2014-07-04
V1.4	Updated the screenshots in the “Scan Engine Parameters Configuration” section of Chapter 3 and added the Admin Settings feature in the same chapter.	2016-10-26

# Table of Contents

<b>Chapter 1 About This Guide .....</b>	<b>1</b>
Introduction .....	1
Documentation Set .....	1
Software Version .....	2
Chapter Descriptions .....	3
More Information .....	3
Service Information .....	3
<b>Chapter 2 Getting Started .....</b>	<b>4</b>
Introduction .....	4
Unpacking .....	4
Accessories .....	4
Getting Started .....	4
Installing the Main Battery .....	4
Charging the Battery .....	5
Keypad .....	5
Power On, Suspend, Wake Up and Power Off .....	6
Calibrating the Screen .....	6
Checking Battery Status .....	7
Installing MicroSD Card .....	8
Installing SIM Card .....	9
Adjusting the Hand Strap .....	9
<b>Chapter 3 Using the PT30 Series .....</b>	<b>10</b>
Introduction .....	10
Status Icons .....	10
Programs Icons .....	11
Settings Icons .....	13
Keypad .....	15
Alphabetic Keypad .....	16
Function Keys .....	16
Stylus .....	16
Volume Control .....	17
Peripheral Module Power control .....	17
Backlight Settings .....	18

Memory Storage Management.....	18
Resetting the PT30.....	19
Warm Reset.....	19
Cold Reset.....	19
Locking the PT30.....	20
Barcode Settings.....	21
Scan Engine Parameters Configuration.....	21
Reading 1D Barcode.....	26
Reading 2D Barcode.....	27
Admin Settings.....	28
<b>Chapter 4 Using Bluetooth Communication.....</b>	<b>29</b>
Bluetooth Config.....	29
Bluetooth Manager.....	30
<b>Chapter 5 Using WiFi Communication.....</b>	<b>31</b>
Main Window.....	31
Profile Window.....	32
Status Window.....	34
Diags Window.....	34
Global Window.....	35
<b>Chapter 6 Using GPRS Communication.....</b>	<b>36</b>
Making New Connection.....	36
Setting Up a Dial-Up Connection.....	38
Checking GPRS Connection Status.....	39
<b>Chapter 7 ActiveSync.....</b>	<b>40</b>
Introduction.....	40
Installing ActiveSync on PC.....	40
Synchronizing Data.....	40
<b>Chapter 8 Accessories.....</b>	<b>41</b>
Battery.....	41
Cradle.....	41
Inserting the PT30 into Cradle.....	41
Removing the PT30 from Cradle.....	41
Charging the Battery.....	41
Charging with Cradle.....	41
Charging with AC Adaptor.....	42

Charging LED .....	42
Scanning/Decoding/Communication LED .....	42
Communicating with PC Directly .....	42
Communicating with PC via Cradle .....	43

**Chapter 9 Maintenance & Troubleshooting..... 44**

Introduction .....	44
Important Safety & Handling Information .....	44
Disassembly and Retrofit .....	44
External Power Supply .....	44
Abnormal Situation .....	44
Drop Damage .....	44
LCD Screen .....	44
Stacking Heavy Objects .....	44
Mounting Location .....	44
Wireless Functionalities .....	45
Use & Maintenance .....	45
Battery Safety Guidelines .....	45
Troubleshooting .....	46

# Chapter 1 About This Guide

## Introduction

This guide provides information about using the PT30 series mobile computer (hereinafter referred to as “**the terminal**” or “**the PT30**”) and accessories.

## Documentation Set

The documentation set for the PT30 provides information for specific user needs and includes:

- ✧ ***PT30 Series Quick Start Guide*** : Describes how to get the PT30 Series up and running.
- ✧ ***PT30 Series User Guide*** : Describes how to use the PT30 Series.

## Software Version



The program can be used to view the terminal's software and hardware version information which is helpful for future updates and maintenance.

The user can obtain the following device information:

- A. System hardware & software version and build time.
- B. The version of WiFi module, and MAC addresses of WiFi and Bluetooth.
- C. The type and version of scan engine.
- D. Version of utility software.



Tap "Start" → "Settings" → "Control Panel" → double click

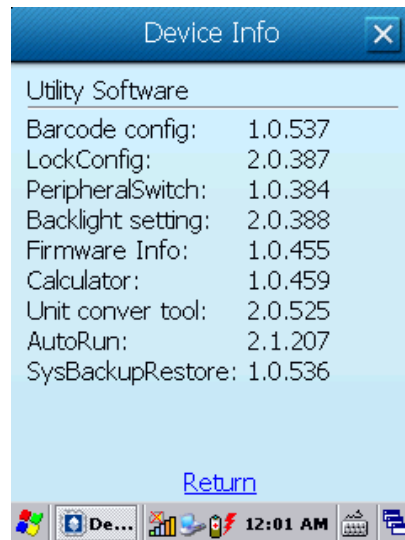
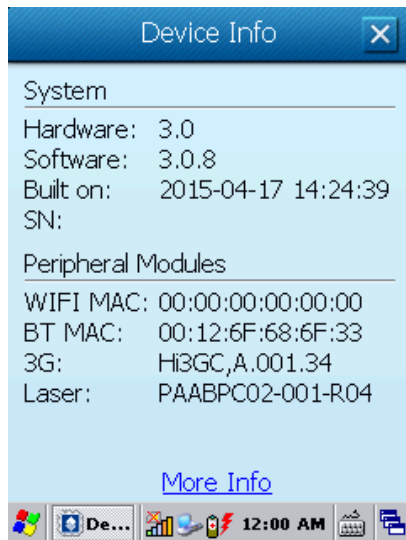

Figure 1.1: Device Information



---

## Chapter Descriptions

- ✧ Chapter 1 About This Guide : Gives a general description of this manual.
- ✧ Chapter 2 Getting Started : Provides information on getting the PT30 up and running for the first time.
- ✧ Chapter 3 Using the PT30 Series : Provides basic instructions for using the PT30.
- ✧ Chapter 4 Using Bluetooth Communication : Explains how to use Bluetooth functionality.
- ✧ Chapter 5 Using WiFi Communication : Explains how to use WiFi functionality.
- ✧ Chapter 6 Using GPRS Communication : Explains how to use GPRS functionality.
- ✧ Chapter 7 ActiveSync : Explains how to synchronize content between the PT30 and the host.
- ✧ Chapter 8, Accessories : Describes the available accessories and how to use them with the PT30.
- ✧ Chapter 9, Maintenance & Troubleshooting : Provides troubleshooting solutions for issues that might occur when using the PT30.

# Chapter 2 Getting Started

## Introduction

This chapter lists the parts and accessories for the PT30 Series and explains how to install, remove and charge the batteries, and get the PT30 up and running.

## Unpacking

Carefully remove all protective material from the pack.

Verify that you received the following:

- ✧ PT30 Mobile Computer
- ✧ USB cable
- ✧ AC adapter
- ✧ Li-Polymer battery
- ✧ Tethered stylus
- ✧ Hand strap
- ✧ Quick Start Guide

## Accessories

- ✧ PT30 single slot cradle
- ✧ PT30 cradle AC adaptor
- ✧ USB cable

## Getting Started

### Installing the Main Battery

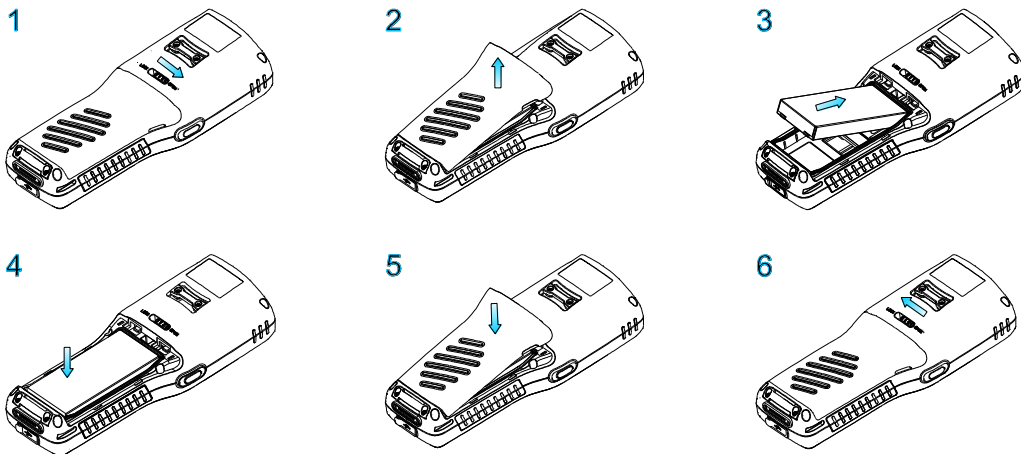

1. Figure 1 indicates the direction to unlock the latch.
2. Figure 2 indicates the direction to take out the battery cover.
3. Follow the instructions of figure 3 and 4 to insert the battery.
4. Follow the instructions of figure 5 to close the battery cover.
5. Push the latch to the locked position.

## Charging the Battery

There are two ways to charge the battery:

- ✧ Charge the terminal via USB connection to PC. Charging time: 6-8 hours.
- ✧ Charge the terminal via AC adapter. Charging time: around 3.5 hours.
- ✧ Charge the terminal for at least 8 hours before first use.

LED indication: red LED: charging in progress; green LED: fully charged.

## Keypad

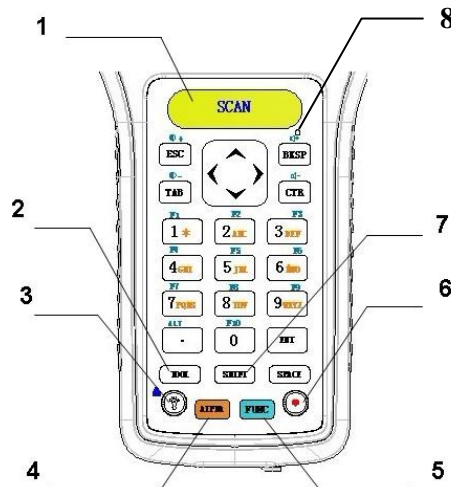

1	SCAN key	Barcode reading button.
2	TOOL key	Pop up the keyboard shortcuts menu (default), or execute the Admin Setting application (when "Sys Shortcut Tools" is turned OFF).
3	Backlight key	Turn screen backlight on or off *Press it down for 7.5s for a warm reset.
4	ALPHA key	Switch between alpha and numeric input.
5	FUNC key	Customize function keys.
6	Power key	Power on/ suspend/ awaken the terminal.
7	SHIFT key	Switch between upper and lower case alphabet entry.
8	Reset key	Warm reset: Insert a straightened paper clip into the hole and press the Reset key in. Cold reset: Hold down the Reset and Power keys.

---

## Power On, Suspend, Wake Up and Power Off

### ❖ Power On:

Press and hold the Power key for 2-3 seconds to turn the terminal on.

### ❖ Suspend:

When the terminal is on, holding down the Power key for 2 seconds will suspend the terminal.

If no operation is performed on the terminal for some time, it will go into the suspend mode (in the case that auto suspend is already enabled).

To set the timer for auto suspend, go to "Start"→"Settings"→"Control Panel"→  →"Schemes".

### ❖ Wake Up:

When the terminal in the suspend mode, press the Power key to wake it up.

### ❖ Power Off:

Tap "Start"→"Shutdown"→"Shutdown" to turn off the terminal. The terminal will backup user data before it shuts down.

## Calibrating the Screen

The calibration tool is for calibrating the touch screen.

Tap "Start"→"Settings"→"Control Panel"→ double-tap  → tap "Calibration".

Click "Recalibrate" button then the screen becomes as shown in Figure 2.2. Carefully press and briefly hold the tip of stylus on the center of each target that appears on the screen. Repeat as the target moves around the screen, then tap the screen to continue.



Figure 2.1: Calibration

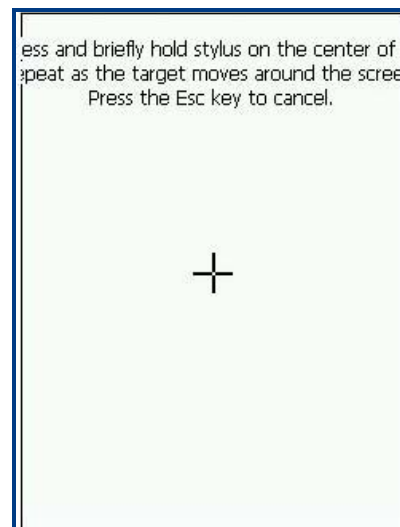

Figure 2.2: Recalibrate

---

## Checking Battery Status

To check the battery status, tap “Start”→“Settings”→“Control Panel”→double click

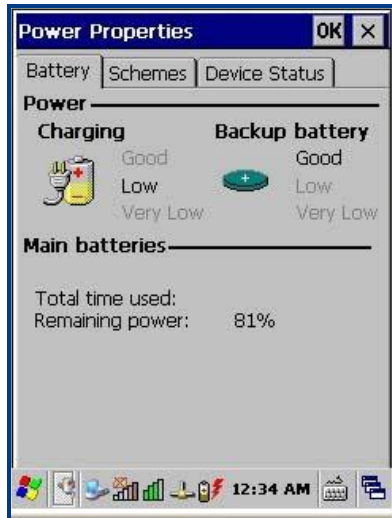

Figure 2.3: Power Properties - Battery

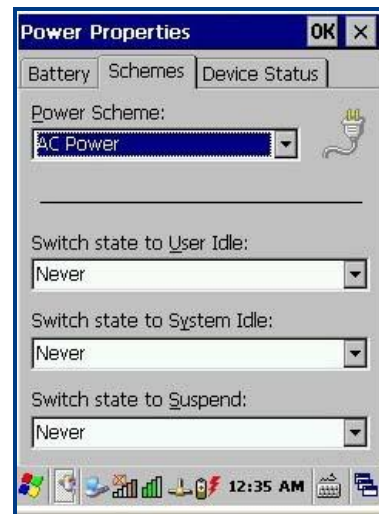

Figure 2.4: Power Properties - Schemes

The system has four states: running, user idle, system idle and suspend:

- ❖ When user operates on the keypad or taps the touch screen, the system is in the running state.
- ❖ After a preset period of inactivity, the system enters the user idle state.
- ❖ After being in the user idle state for a preset period of time, the system enters the system idle state.
- ❖ After being in the system idle state for a preset period of time, the system enters the suspend state.

---

## Installing MicroSD Card

The terminal provides a MicroSD card slot for external storage. The slot is beneath the battery compartment. Follow the instructions of the card manufacturer to use the card.

Insert the MicroSD card into the card slot, with its metal contacts facing down, as shown below.

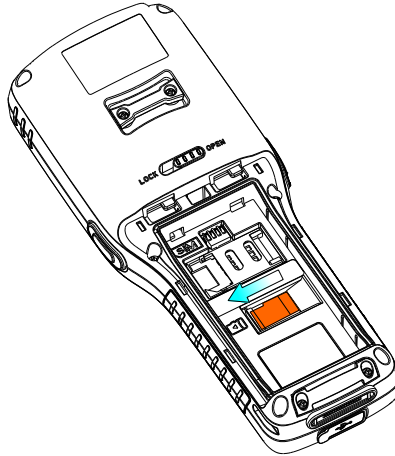

Note that the MicroSD card may not function in any of the following conditions:

1. MicroSD card: It is infected with virus, damaged, or not formatted properly, or its metal contacts are dirty.
2. Card slot: It is squeezed or damaged, or its metal contacts are rusted or bent excessively.
3. Battery: The battery voltage is unstable.

---

## Installing SIM Card

The SIM card slot is beneath the battery compartment and it is available only to the PT30 with GPRS model.

1. Take out the battery. Push the cover release latch in the direction indicated in figure 1 to release the slot cover and open the cover.
2. Insert the SIM card into the slot, with its metal contacts facing down.
3. Push the latch to lock the slot cover in place.

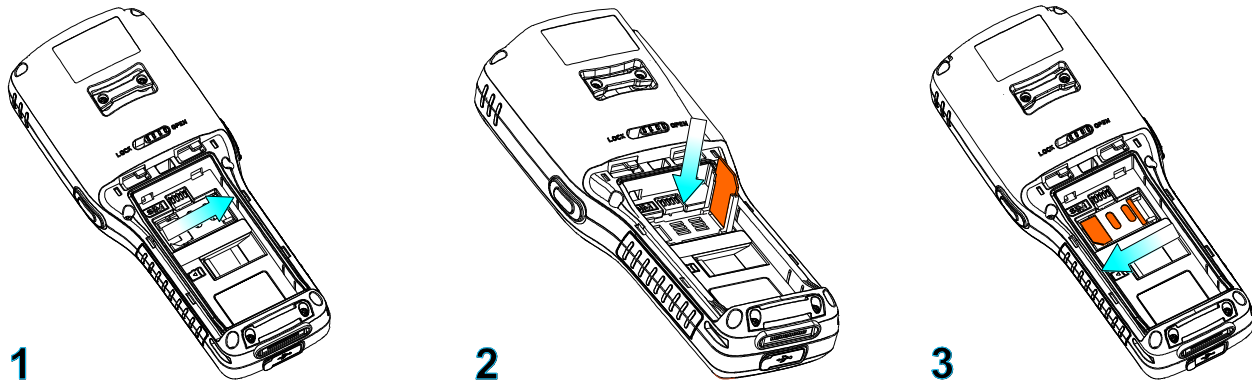

## Adjusting the Hand Strap

A hand strap can be attached to the terminal. Adjust the hand strap to increase comfort when holding the terminal for extended periods of time.

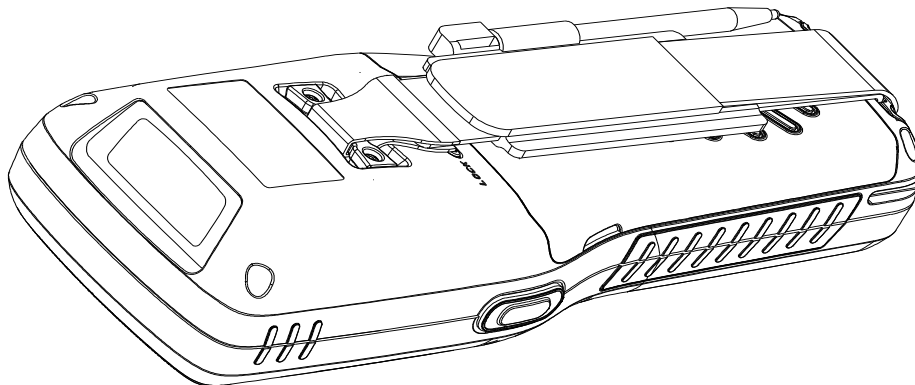

## Chapter 3 Using the PT30 Series

### Introduction







This chapter provides the detailed instructions for using and setting the PT30.







Figure 3.1: Desktop Icons

### Status Icons







The status bar at the bottom of the screen can contain the following status icons.











Icon	Description
	Bluetooth management tool.
	Lowercase input. Press the ALPHA key to toggle between numeric and alphabetic (lowercase) keypad.
	Uppercase input. Press the SHIFT key to toggle between uppercase and lowercase.
	Caps Lock. When alphabetic keypad is enabled, double press the SHIFT key to turn Caps Lock on.
	FUNC key.
	IP information.



	USB connection status.
	Battery status.
	WiFi signal strength.
<b>20:04</b>	Clock.
	Soft input panel.
	Background running program selection window.







## Programs Icons

Icon	Program Name	Description
 Stylus	Stylus	Touch screen calibration tool.
 Light Setting	Light Setting	Screen and keyboard backlight setting tool.
 Peripheral Switch	Peripheral Switch	Peripheral module power control.
 Calculator	Calculator	Numeric calculation.
 Unit Converter	Unit Converter	Unit conversion tool.
 Microsoft WordPad	Microsoft WordPad	Microsoft WordPad text editing tool.







 LockConfig	LockConfig	Keyboard and touch screen lock/unlock tool.
 WiFi SCU	WiFi	WiFi communication management and configuration tool.
 Bluetooth Device ...	Bluetooth Device Properties	Bluetooth communication management and configuration tool.
 Barcode Setting	Barcode Setting	Barcode engine configuration tool.
 Autorun	Autorun	Set the programs and parameters which need to boot automatically at startup.
 SysBackup...	SysBackupRestore	Backup/restore system registry, configuration and data in storage memory.
 Firmware Information	Firmware Information	Check the system firmware information and version.
 Putty	Putty	Telnet terminal emulation tool.
 RegEdit	RegEdit	System registry editing tool.
 uEasyFileCE	uEasyFileCE	Bluetooth file transfer utility.

---

## Settings Icons

Icon	Description
 Volume & Sounds	System volume control.
 Internet Options	Internet options settings.
 PC Connection	Enable/disable connections with host PC.
 Storage Manager	Memory storage management and configuration. (Use it with discretion)
 Power	Power properties (battery, schemes and device status) settings.
 Password	Passwords (power on password and screen saver password) settings.
 Date/Time	System date, time and time zone settings.
 Regional Settings	Region, language and input method settings.
 Dialing	Dialing configuration.

---

 Remove Programs	Remove programs installed on the terminal.
 Input Panel	Input panel settings.
 Owner	Owner properties settings.
 Network and Dial-up Co...	GPRS connection configuration.
 System	View system information.
 Display	Change your desktop background (wallpaper).
 Certificates	View the certificates installed on the terminal.

## Keypad

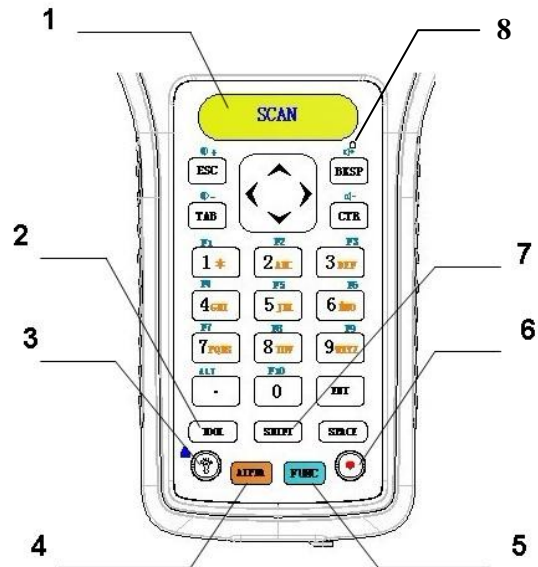



1	SCAN key	Scan barcode key.
2	TOOL key	Pop up the Keyboard Shortcuts menu (default), or open the Admin Setting application (when Sys Shortcut Tools is turned OFF).
3	Backlight key	Turn screen backlight on or off. *Press and hold it for 7.5s for a warm reset.
4	ALPHA key	Toggle between alphabetic and numeric keypad.
5	FUNC key	Customize function keys.
6	Power key	Power on/ suspend/ awaken the terminal.
7	SHIFT key	Switch between uppercase and lowercase mode (effective only when alphabetic keypad is enabled).
8	Reset key	Warm reset: Insert an appropriate pin into the hole and press the Reset key in. Cold reset: Hold down the Reset and Power keys.

## Alphabetic Keypad

Numeric Key	ALPHA key locked				ALPHA & SHIFT keys locked			
	1st	2nd	3rd	4th	1st	2nd	3rd	4th
1	*							
2	a	b	c		A	B	C	
3	d	e	f		D	E	F	
4	g	h	i		G	H	I	
5	j	k	l		J	K	L	
6	m	n	o		M	N	O	
7	p	q	r	s	P	Q	R	S
8	t	u	v		T	U	V	
9	w	x	y	Z	W	X	Y	Z

## Function Keys

- ✦ FUNC key + Backlight key: Lock/unlock the terminal.  
After the FUNC key is pressed, it is locked; it becomes unlocked after another keypress is made.
- ✦ The ALPHA key and FUNC key are independent from each other, so they do not override each other.
- ✦ The SHIFT key works only when the alphabetic keypad is enabled (i.e. the ALPHA key is pressed and locked).
- ✦ When the ALPHA key is pressed and locked, the SHIFT key's intended functions are described as follows:
  - When the SHIFT key is not pressed, the lowercase mode is enabled with the status bar displaying .
  - When the SHIFT key is pressed once, the uppercase mode becomes enabled with the status bar displaying  until any key on the keypad is pressed, be it an alphabetic key or not.
  - When the SHIFT key is pressed twice within an interval of 0.5 seconds, Caps Lock is turned ON with the status bar displaying . To switch to the lowercase mode, simply press the SHIFT key.
- ✦ Long press or double press the TOOL key: Pop up the Keyboard Shortcuts menu (default).
- ✦ TOOL key + a number key (1-9): Run the corresponding program on the Keyboard Shortcut menu.

## Stylus

Use the stylus to select items and enter information. The stylus functions as a mouse.

- ✦ Tap : Tap an item on the screen with the stylus to select it.
- ✦ Tap and Hold : Tap and hold an item with the stylus to view a list of actions available for that item.
- ✦ Drag : Hold the stylus on the screen and drag across the screen to select text. Drag multiple items in a list to select them.

**CAUTION: To prevent damage to the screen, only use the stylus provided by Newland.**

## Volume Control

Tap “Start”→“Settings”→“Control Panel”→ double-click  and move the slider to the right or left to raise or lower the volume.

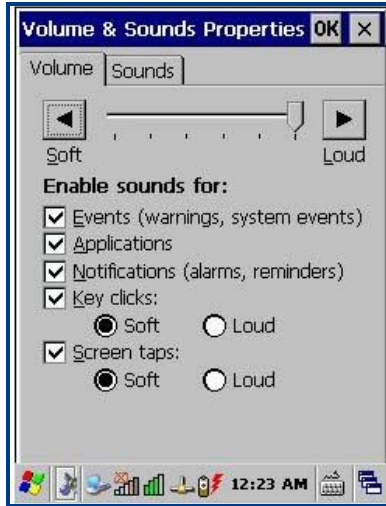

Figure 3.2: Volume

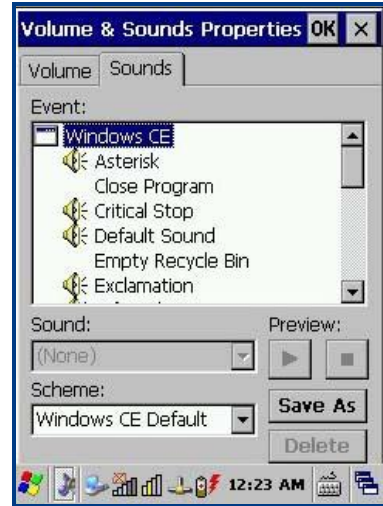



Figure 3.3: Sounds

## Peripheral Module Power control

The program  is for users to quickly turn GPRS/3G/Bluetooth/WiFi module on or off.

Tap “Start”→“Settings”→“Control Panel”→double click  to open the program.

Tap “ON” or “OFF” to turn the module on or off. By default, GPRS and WiFi are ON and Bluetooth is OFF.



Figure 3.4: Peripheral Switch

---

## Backlight Settings

Tap “Start”→“Settings”→“Control Panel”→double click  .

### ❖ Screen Backlight:

- **Normal Mode:**

Normal mode applies when the system is in the running state. There are 11 levels (0-10) of screen brightness for this mode.

- **Low-power Mode:**

Low-power mode allows users to dim the screen to save power if no operation is performed on the screen and keyboard for a preset period of time (switch timer). There are 8 levels (0-7) of screen brightness for this mode. Brightness level for the normal mode must be greater than that for low-power mode.

- **Switch Timer**

Users may set the period of inactivity required to automatically switch from normal mode to low-power mode.

### ❖ Keyboard Backlight:

Users may set the period of keyboard inactivity required to automatically turn off keyboard backlight.

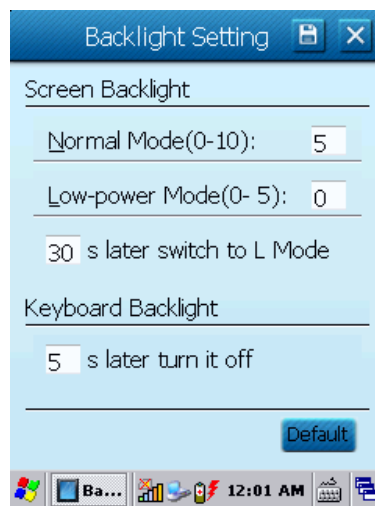



Figure 3.5: Backlight Setting

## Memory Storage Management

**Caution: When the settings are improperly configured on the memory storage management, system failures may occur. Non-technical staff shall not make any change to it.**

The program  is a tool for managing the memory.



- ✧ Format : Format the selected memory, the data in memory will be destroyed after memory is formatted.
- ✧ Dismount : Dismount the selected memory.
- ✧ New Partitions : Create a new partition in selected memory.
- ✧ Delete Partitions : Delete an existing partition in selected memory.

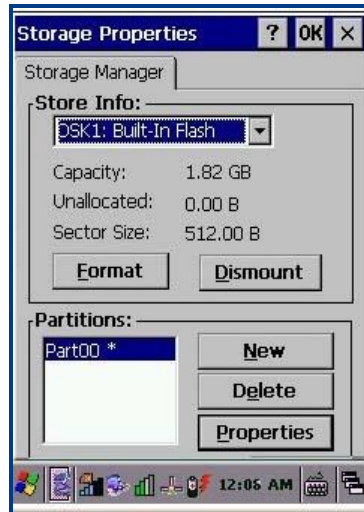

Figure 3.6: Memory Configuration

## Resetting the PT30

### Warm Reset

Press the Reset button or hold down the Backlight key for 7.5 seconds to perform a warm reset on the terminal. It will take 6-10 seconds to restart the system. User data in memory will not be lost.

### Cold Reset

Method 1: Hold down the Power key and then press the Reset button. Do not release the Power key until the terminal displays the loading screen.

Method 2: Press and hold the Power and Backlight keys till the terminal displays the loading screen.

It will take 16-20 seconds for the terminal to reboot. After a cold reset, the terminal will restore factory default settings and user data that is not in MicroSD card or flash disk will be lost. You can use backup/restore tool to restore backup data.

**Note: The battery cover must be closed after the Reset button is pressed, otherwise the terminal will immediately enter the suspend mode after restarting.**

---

## Locking the PT30

User can lock or unlock the terminal using the program  LockConfig .

Tap "Start" → "Settings" → "Control Panel" → double click  LockConfig to run the program.

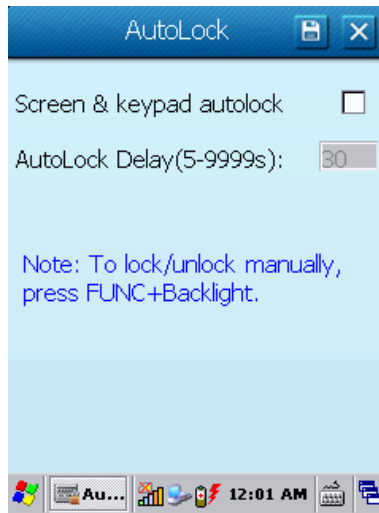

Figure 3.7: Auto Lock

### Lock the keyboard and touch screen:

Method 1: If no operation is performed on the PT30 for some time (user programmable), the keyboard and touch screen will be locked automatically.

Method 2: Press the FUNC and Backlight keys simultaneously.

### Unlock the keyboard and touch screen:

Method 1: Press the FUNC and Backlight keys simultaneously.

Method 2: Tap the screen or press any key and then tap "Unlock" on the screen.

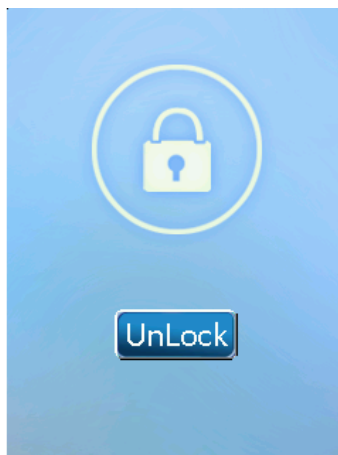

Figure 3.8: Locked State

# Barcode Settings

## Scan Engine Parameters Configuration

Tap "Start" → "Settings" → "Control Panel" → double click

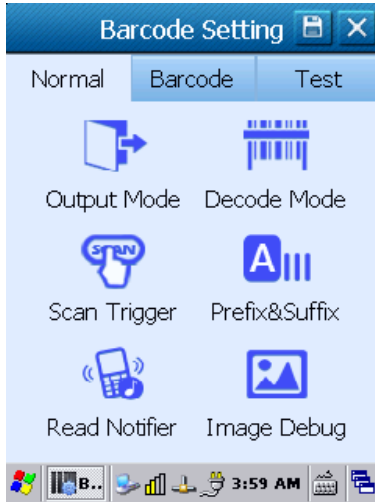

Figure 3.9: Normal Settings

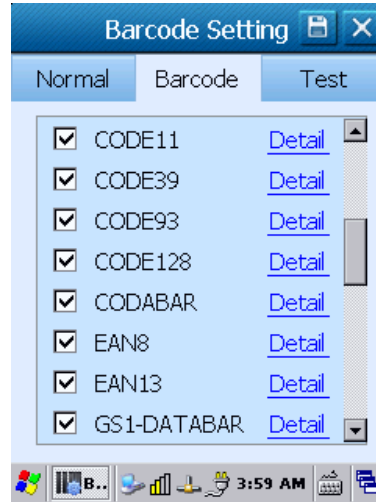

Figure 3.10: Barcode Settings

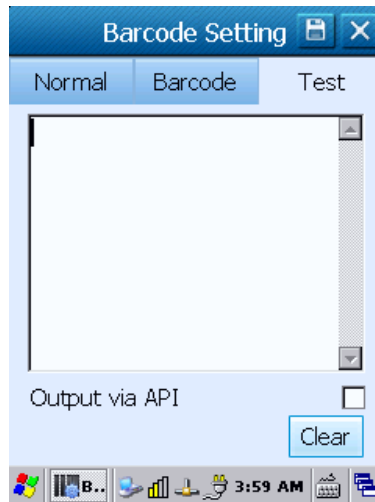

Figure 3.11: Test

❖ Output Settings:

- Output via API : Use program API libraries control to get the barcode data.
- Output via keyboard : Output the barcode data to keyboard buffer to simulate keyboard input.
- Output via clipboard : Output the barcode data to clipboard.

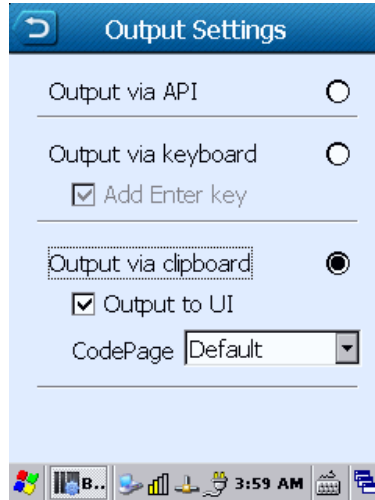

Figure 3.12: Output Settings

❖ Scan Mode Settings:

- Scan Mode:
  - Level mode : Press the key to start a decode session which continues until the key is released.
  - Pulse mode : Press the key to start a decode session which continues until barcode decodes or the decode session timeout expires.
  - Continuous mode : Scan barcodes continuously until the scan mode is changed.
  - API mode : Start or stop scanning barcode by API software.
- Timeout and Interval:

Timeout sets the maximum time decode session continues during a scan attempt, the default value is 4000ms. Interval sets the time period between decode sessions, the default value is 100ms.

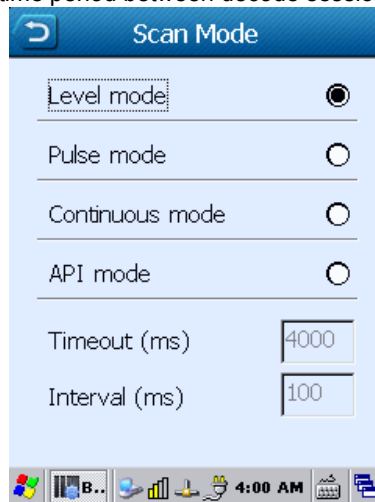

Figure 3.13: Scan Mode

✧ Scan Trigger:

Select a key or key combination as scan trigger by checking the item.

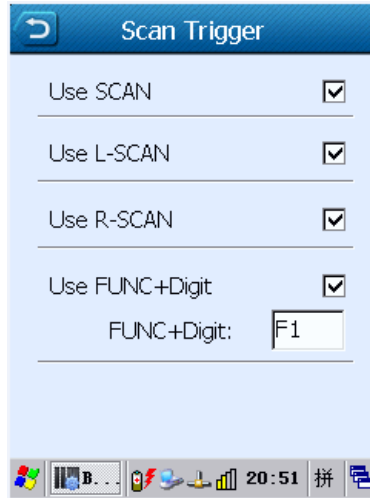

Figure 3.14: Scan Trigger

✧ Good Read Notifier:

Select an indicator for good read.

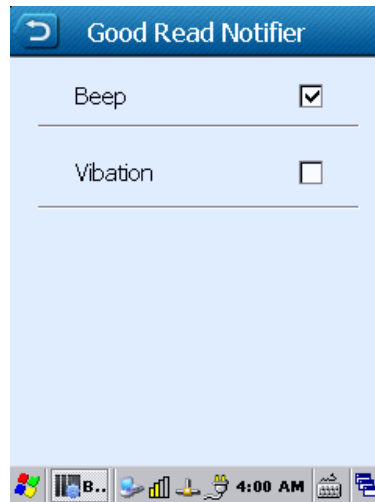

Figure 3.15: Good Read Notifier

✧ Prefix and Suffix:

Set a prefix/suffix that you want to append to barcode data.

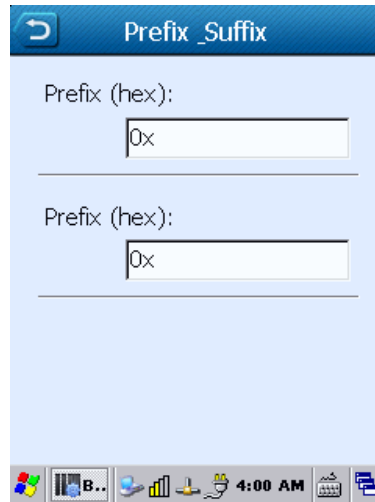

Figure 3.16: Prefix & Suffix

✧ Symbolologies:

List of configurable symbolologies varies by the product model.

- Enable/disable a barcode symbology.
- Set parameters of a barcode symbology.

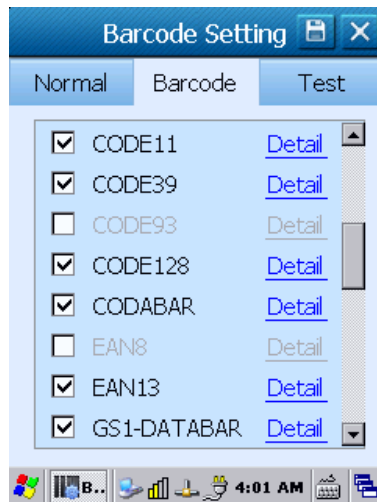

Figure 3.17: Enable/Disable Barcode

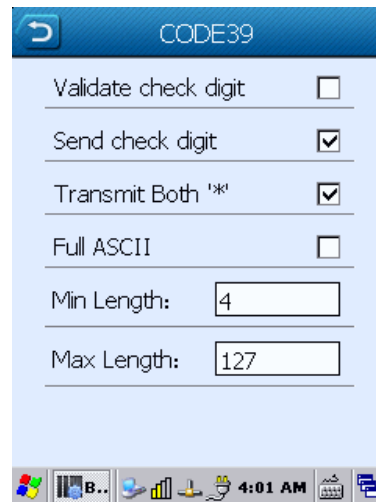

Figure 3.18: Set Barcode Parameters

✧ Test

Tap **“Test”** on the Barcode Settings screen (Figure 3.10). Scan a barcode with the terminal. Decoded data will appear in the textbox as shown in Figure 3.19 after a good read.

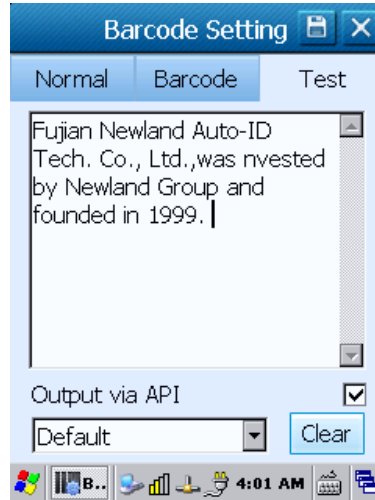

Figure 3.19: Test

✧ 2D Image Debugger

This feature only applies to the PT30 equipped with 2D scan engine.

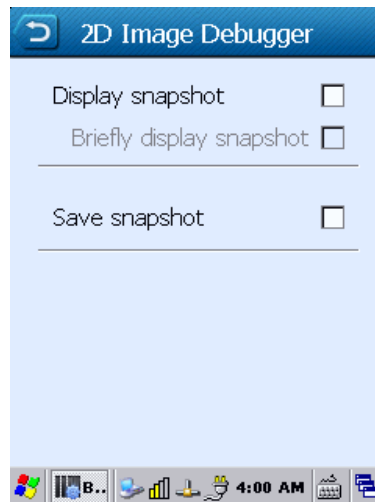
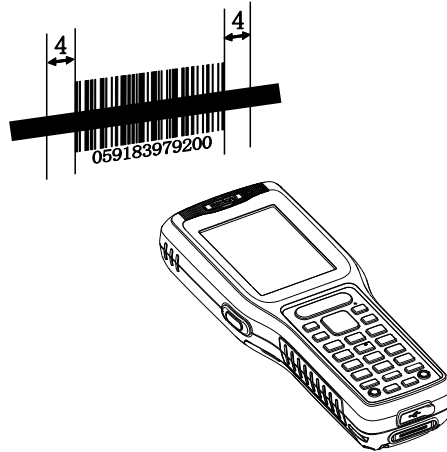

Figure 3.20: 2D Image Debugger

---

## Reading 1D Barcode

Adjust the scan angle or the distance between the terminal and the target barcode to ensure the length of laser beam is roughly 8mm greater than that of the barcode, as shown in the following figure.



Right and wrong way of reading:





---

## Reading 2D Barcode

Adjust the scan angle and the distance between the terminal and the target barcode to make them fall into the following ranges:

- A. Point the terminal's focus lamp at the center of the barcode.
- B. Optimum scan distances: 5-20cm.

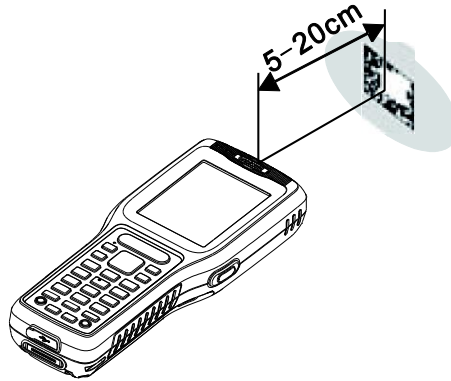

### C. Optimum scan angles:

- Pitch ( $\alpha$ ) < 45° (0° preferably)
- Skew ( $\gamma$ ) < 45° (5° - 20° preferably)
- Roll ( $\beta$ ) = 0° - 360°

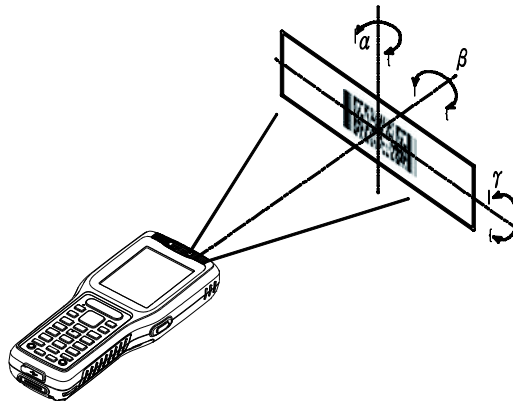

---

## Admin Settings

To run the Admin Setting application, long press or double press the TOOL key on the terminal to open the Keyboard

Shortcuts menu (default), and then double tap . Users will be asked to set the admin password when using it for the first time.

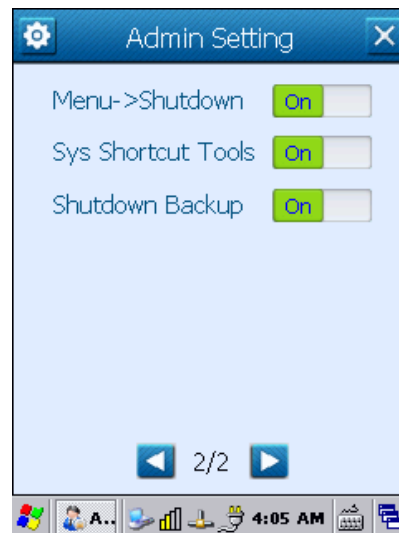
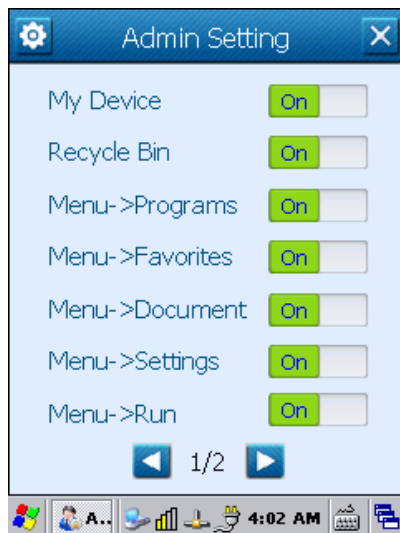
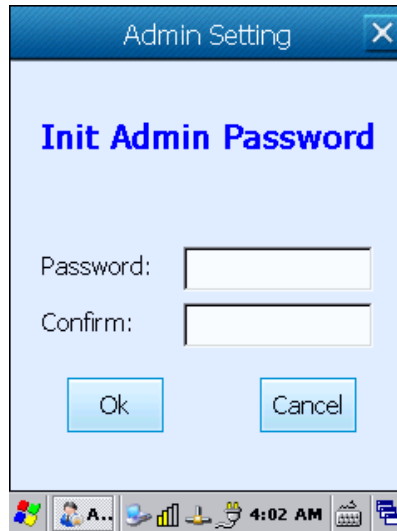

**My Device/Recycle Bin:** Turn it on (default) or off to show or hide the icon on the desktop.

**Menu->XX:** Turn it on (default) or off to show or hide XX in the Start menu.

**Sys Shortcut Tools:** When it is On (default), double pressing the TOOL key will open the Keyboard Shortcuts menu; when it is Off, double pressing it will open the Admin Setting application.

**Shutdown Backup:** Turn it on (default) or off to enable or disable automatic backup during the shutdown process.

# Chapter 4 Using Bluetooth Communication

## Bluetooth Config

Double click  in the status bar, or click this icon and then select “BT Config” to display the BT Configuration window (Figure 4.2).



Figure 4.1: Desktop



Figure 4.2: BT Configuration (Basic)

- A. Set device name and pin code as per your needs.
- B. Tap the “Option” tab and then select “Discoverable mode”/ “Connectable mode” and “Authentication mode” as per your needs (Figure 4.3).



Figure 4.3: Option

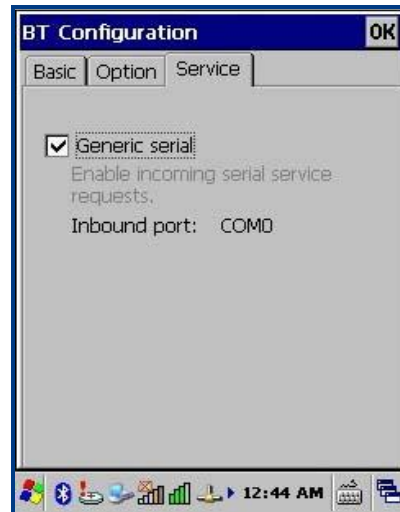

Figure 4.4: Service

C. Tap the “Service” tab and then select “Generic serial” as per your needs (Figure 4.4).

## Bluetooth Manager

Click  in the status bar and then select “BT Manager” to display the BT Manager window (Figure 4.5). You can search for Bluetooth devices and services and pair & connect with a Bluetooth device as per actual needs. For an application program using Bluetooth communication, the terminal will attempt to connect to the most recently connected Bluetooth device automatically if no Bluetooth device is connected to it currently.



Figure 4.5: BT Manager (Pair & Link)



Figure 4.6: Search for Bluetooth Devices



Figure 4.7: Search Services

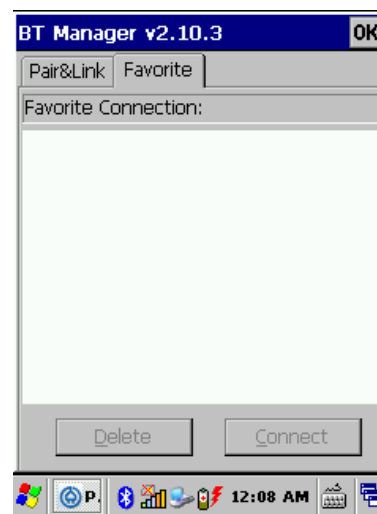



Figure 4.8: Favorite Connections

## Chapter 5 Using WiFi Communication

SCU (Summit Client Utility), a Wi-Fi configuration, monitoring and management application, allows users to search Wi-Fi networks that are available to connect to, monitor status information on Wi-Fi and configure wireless parameters such as IP

address and gateway. Tap “Start”→“Settings”→“Control Panel”→double click  to open SCU.

### Main Window

The Main window provides an overview of the current wireless network connection configuration (Active Profile) Figure 5.1 is the SCU Main windows for Windows CE.



Figure 5.1: SCU Main Window

#### Enable Radio/Disable Radio

When the radio is enabled, tap this button (which displays Disable Radio) to disable it. When the radio is disabled, tap the same button (which now displays Enable Radio) to enable it. When disabled, the radio does not attempt to make a connection to an access point.

#### Active Profile

It displays the name of the active profile. You may use the drop-down menu to select a different profile.

Note: If “ThirdPartyConfig” is selected (and after the device goes through a power cycle), WZC (Windows Zero Configuration) or another application is used to configure the SSID, Auth Type, EAP Type, and Encryption settings.

#### Status

It indicates the current status of the Summit radio. Connection statuses include:

- ❖ Down - The radio is not recognized by Summit software and therefore is not associated and nor authenticated.
- ❖ Disabled - The radio is disabled. To enable the radio, tap Enable Radio located on the SCU Main window. When the radio is disabled, it does not attempt to make a connection to an access point.
- ❖ Not Associated - The radio has not established a connection to an access point.
- ❖ Associated - The radio has established a connection to an access point.

If the radio Encryption type is set to WEP or a pre-shared key (WPA-PSK or WPA2-PSK), it should now be capable of obtaining an IP address (either statically assigned or through DHCP) and passing traffic.

If the radio Encryption type requires EAP authentication then an EAP Type must be properly configured in order for the device to obtain an IP address and be capable of passing traffic.

<EAP type> Authenticated - The radio has established a connection to an access point and has completed EAP authentication successfully.

### Radio Type

It indicates the type of radio installed in the device. For example:

- ❖ BG - Indicates a Summit 802.11g radio which supports 802.11b and 802.11g.
- ❖ ABG - Indicates a Summit 802.11a/g radio which supports 802.11a, 802.11b, and 802.11g.
- ❖ N - Indicates a Summit 802.11n radio which supports 802.11a, 802.11b, 802.11g, and 802.11n.

## Profile Window

Profile settings are radio and security settings that are stored for each configuration profile. When a profile is selected as the active profile on the Main window, the settings for that profile become active.

Notes: When the ThirdPartyConfig profile is selected, a power cycle must be performed.

Figure 5.2 is the SCU Profile windows for Windows CE.



Figure 5.2: SCU Profile Window

Profile changes are not saved to the profile until you tap “Commit”.

#### Using Scan to Create a Profile

When you tap “Scan” on the Profile window, SCU displays a list of that are broadcasting their SSIDs. Figure 5.3 below is an example of a Scan window.

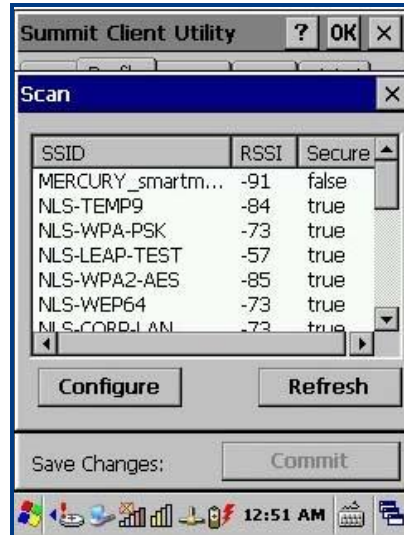

Figure 5.3: Scan Window

Each row shows an AP's SSID, its received signal strength indication (RSSI), and whether or not data encryption is in use (true or false). You can sort the list by tapping on the column headers. If the scan finds more than one AP with the same SSID, the list displays the AP with the strongest RSSI and the least security. Every five seconds, the Scan window updates the RSSI value for each of the APs in the list. To scan for new APs and view an updated list, tap “Refresh”.

If you are authorized as an administrator in SCU, you can create a profile for any SSID in the list. To create a profile, double-tap the row for the SSID; or tap the row and then tap “Configure”.

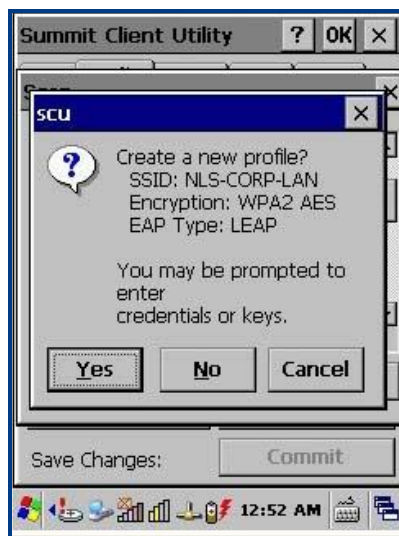

Figure 5.4: Scan Window

If you tap “Yes” on the dialog box, then SCU creates a profile for that SSID, with the profile name being the same as the SSID (or the SSID with a suffix such as “\_1” if a profile with the SSID as its name exists already). If the AP is using WEP,

---

then SCU opens a dialog box in which you can specify WEP keys. If the AP is using EAP, then SCU opens a dialog box in which you can specify login credentials for the EAP type (which SCU assumes is LEAP). After you enter information on a dialog box, you return to the SCU Profile window, where you can view and edit profile settings. If you make any changes, then you must tap “Commit” to save the changes.

## Status Window

The Status window provides status information on the radio connection between the client device and the access point to which it's associated.

The following image is the SCU Status windows for Windows CE.



Figure 5.5: SCU Status Window

## Diags Window

The Diags window enables you to troubleshoot connection issues with SCU. The following image is the SCU Diags windows for Windows CE.



Figure 5.6: SCU Diags window



---

### **(Re)connect**

Initiate a reconnect of the radio: Disable and enable the radio, apply (or reapply) the current profile, attempt to associate to the wireless LAN, and attempt to authenticate to the wireless LAN.

### **Release/Renew**

Obtain a new IP address through DHCP release/renew.

### **Start Ping/Stop Ping**

Start a continuous ping to the address in the edit box next to the button. Once the button is tapped, its name and function changes to Stop Ping. Pings continue until you tap Stop Ping, move to a different SCU window (other than Diags or Status), exit SCU, or remove the radio.

## **Global Window**

Global settings include radio and security settings that apply to all profiles and settings that apply to SCU itself. An administrator can define and change most global settings on the Global window in SCU.

The following image is the SCU Global windows for Windows CE.



Figure 5.7: SCU Global window

## Chapter 6 Using GPRS Communication

Ensure that an activated SIM card, from the phone service provider, is installed in the terminal. By default, a GPRS connection is already created on the PT30. You can tap “Start”→“Settings”→“Control Panel”→“Network and Dial-up Connections”, and then double click the GPRS icon to initiate GPRS communication if you are located in China. If you are not located in China, you may either modify the existing GPRS connection or create a new connection by following the instructions below.

### Making New Connection

To create a new connection, follow the steps below:

- A. Double click the “Make New Connection” icon (Figure 6.1).
- B. Type “GPRS” or any desired name for the connection and then tap “Next” (Figure 6.2).



Figure 6.1: Make New Connection

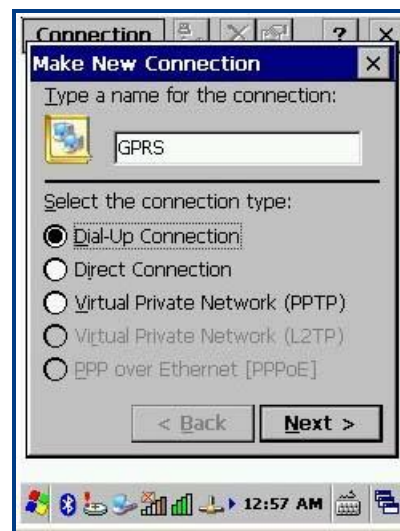

Figure 6.2: Name the connection

- C. Select “Wireless modem Port” in the field of “Select a mode” and tap “Configure...” (Figure 6.3).
- D. Leave the Port Settings at their default values (Figure 6.4).



Figure 6.3: Modem

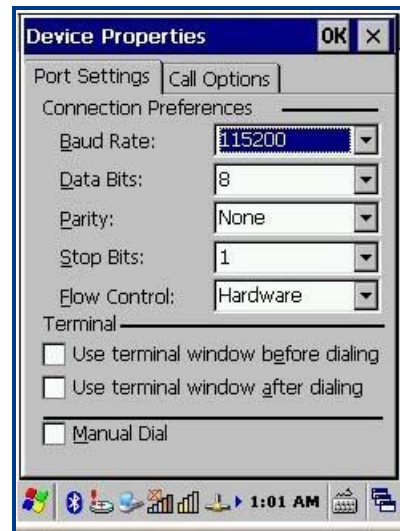

Figure 6.4: Port Settings

- E. Tap the “Call Options” tab. Type **[+cgdcont=1,“IP”,“cmnet”]** in the field at the bottom of the screen. “cmnet” is an example of GPRS APN (access point name). Contact your GPRS service provider to obtain this information. Tap “OK” at the top of the window.

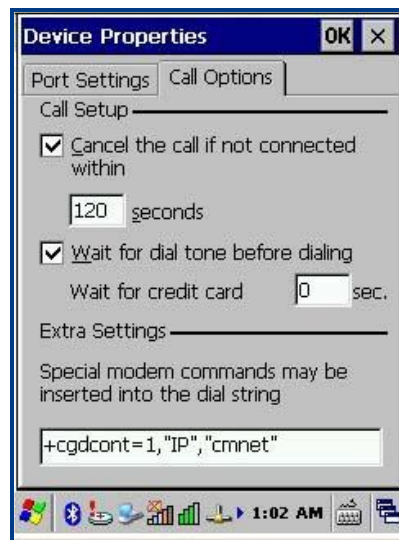

Figure 6.5: Call Options

- F. Enter the phone number in the corresponding field. Tap “Finish” (Figure 6.6).
- G. Then the new connection will appear on the screen. Double click it if you want to initiate GPRS communication.

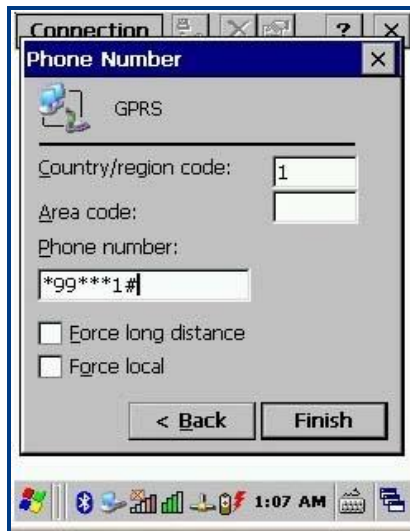

Figure 6.6 Set phone number

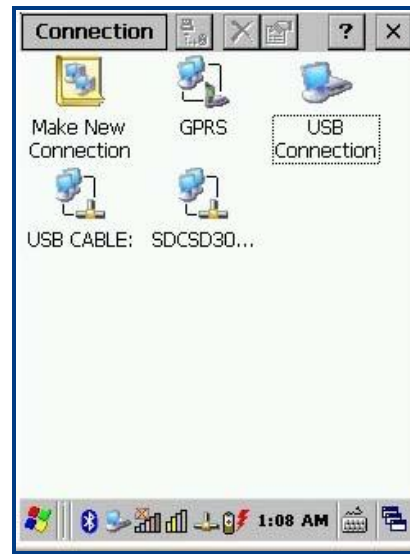

Figure 6.7: New connection created

## Setting Up a Dial-Up Connection

To set up a dial-up connection, follow the steps below:

- A. Click "Dial Properties..." in the window as shown in Figure 6.8.
- B. Click "Edit..." in the window as shown in Figure 6.9.



Figure 6.8: Dial-up connection



Figure 6.9: Dialing properties

- C. Enter "G" in the three input fields in the window as shown in Figure 6.10 respectively, and click "OK" at the top of the window. Then click "OK".
- D. Click "Connect" (Figure 6.11).

E. Wait 3-5 seconds for the settings to complete.

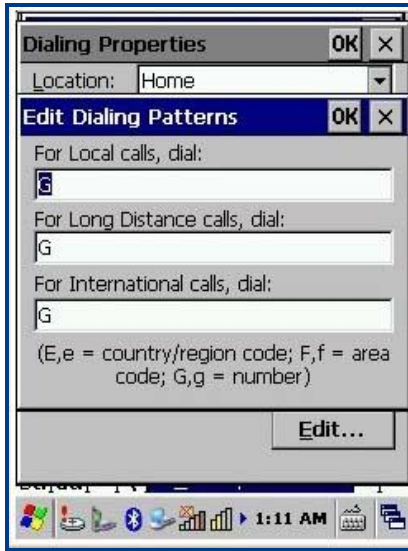

Figure 6.10



Figure 6.11

## Checking GPRS Connection Status

Click  in the status bar at the bottom of the screen to view the GPRS connection status.



Figure 6.12: GPRS status

# Chapter 7 ActiveSync

## Introduction

Microsoft ActiveSync (version 4.5 or higher) is required when you want to synchronize data between the terminal and PC.

## Installing ActiveSync on PC

Download ActiveSync (version 4.5 or higher) from the Microsoft web site at <http://www.microsoft.com> and install it on your PC.

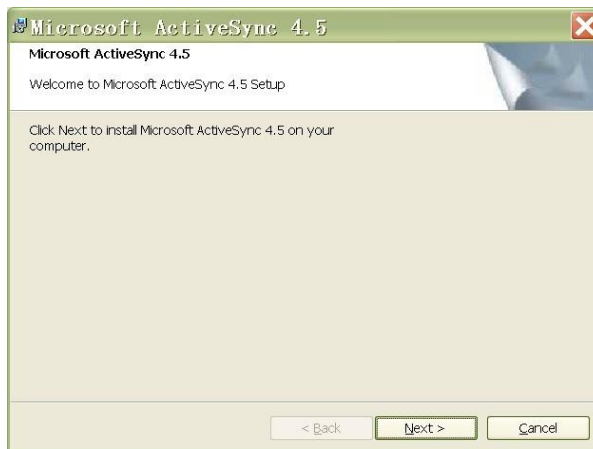

Figure 7.1 ActiveSync Installation interface

## Synchronizing Data

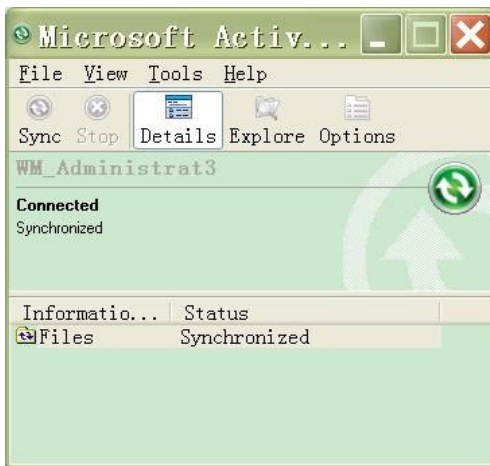

Figure 7.2: Synchronize details

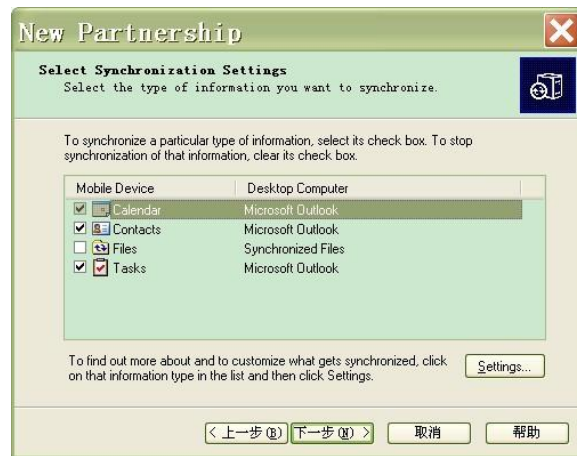

Figure 7.3 Choose item(s) to synchronize

## Chapter 8 Accessories

### Battery

Low battery may result in misoperation of the terminal. Before your first use, charge the battery for at least 8 hours to ensure both the main and backup batteries are fully charged.

### Cradle

#### Inserting the PT30 into Cradle

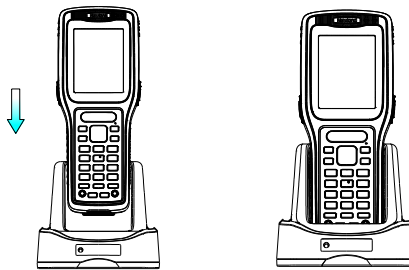

#### Removing the PT30 from Cradle

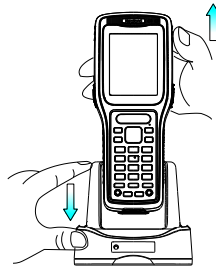

### Charging the Battery

#### Charging with Cradle

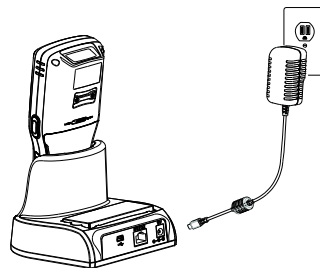

---

## Charging with AC Adaptor

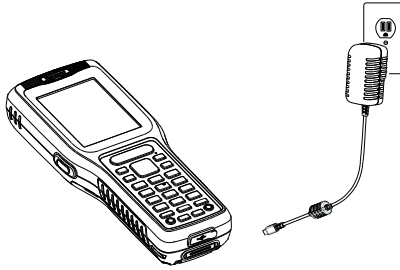

## Charging LED

Red LED on: Charging in progress.

Green LED on: Fully charged.

## Scanning/Decoding/Communication LED

Red LED on: The terminal is scanning barcode.

Green LED on: A barcode is decoded.

Blue LED flashes: BT/WiFi/GPRS/3G module in the PT30 is communicating.

## Communicating with PC Directly

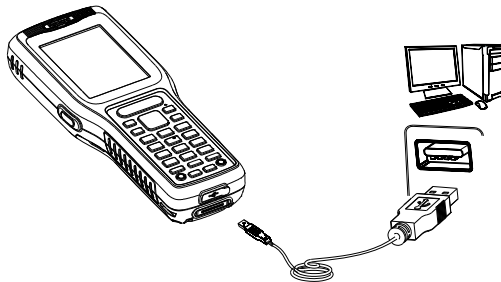

1. Open the USB port cover located at the bottom of the PT30.
2. Plug one end of the USB cable into the USB port on the PT30 and the other end of the cable into PC.

**Note:** Make sure Microsoft ActiveSync is already installed on the PC before performing data communication between the terminal and the PC.



---

## Communicating with PC via Cradle

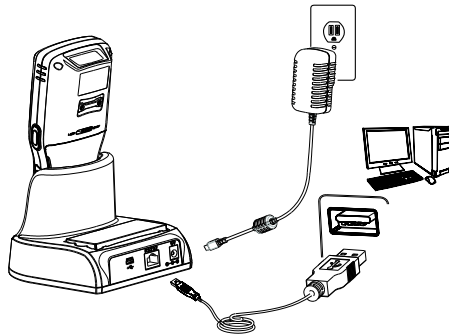

1. Insert the PT30 into the dedicated cradle.
2. Plug one end of the USB cable into the USB port on the cradle and the other end of the cable into PC.

**Note: Make sure Microsoft ActiveSync is already installed on the PC before performing data communication between the terminal and the PC.**

# Chapter 9 Maintenance & Troubleshooting

## Introduction

This chapter includes important safety and handling information and provides troubleshooting solutions for issues that might occur when using the terminal.

## Important Safety & Handling Information

### Disassembly and Retrofit

Do not disassemble or retrofit the terminal by yourself. Artificial damages caused by failure to observe this precaution are not covered by the warranty.

### External Power Supply

Use only the supplied AC adapter. Otherwise there is a risk of damage to the terminal.

### Abnormal Situation

Keep the terminal away from fire or heat sources. If there is unusual odor, overheating or smoke, immediately cut off the power and disconnect the AC adapter, and contact your dealer or Newland customer service center. Continued use in this case may result in fire or electric shock.

### Drop Damage

If the terminal is damaged due to a drop from high place, immediately cut off the power and contact your dealer or Newland customer service center.

### LCD Screen

Do not press against or strike the LCD screen. Otherwise it may damage the screen. When handling a cracked or shattered screen, do not touch the liquid that has leaked from it to avoid skin burn or infection.

### Stacking Heavy Objects

Do not place heavy objects on the terminal as those objects may fall and cause injury.

### Mounting Location

Do not place the terminal on unstable or uneven surfaces as it may fall and cause injury. Do not expose the terminal to humidity, dust or direct sunlight.

---

## Wireless Functionalities

Do not use the terminal's wireless functionalities where wireless device use is prohibited or where it may cause interference or danger, such as in aircrafts, petrol stations.

## Use & Maintenance

- ✧ If the terminal cannot be switched on after experiencing a sudden or unexpected power loss or other abnormalities, try performing a warm reset on the terminal by pushing the Reset button with a pin. For the location of the button, please refer to the related chapter.
- ✧ Do not throw, drop or strike the terminal. Doing so may damage the LCD display, interrupt running programs, cause data loss in memory and result in malfunction.
- ✧ Clean the scan window regularly. Do not touch it with hands. Scratched or smudged window may degrade reading performance.
- ✧ Do not tap the touch screen with sharp objects. Doing so may damage the screen or cause internal short circuits.
- ✧ Use only a dry soft cloth to clean the terminal. Cleaning it with wet cloth or benzene/ thinner/ other volatile chemicals may deform and shorten the useful life of the keyboard and shell of the terminal.
- ✧ Do not place the terminal facedown on any surface, or there might be misoperations.
- ✧ Sudden temperature drops may cause condensation on the shell which could cause malfunction. If condensation occurs, dry the terminal before use.

## Battery Safety Guidelines

- ✧ Do not dispose of batteries in a fire as they may explode!
- ✧ The battery can be charged and discharged over 500 times. If the battery life is unreasonably short, please replace the battery with a new one.
- ✧ Use only the manufacturer-approved battery and AC adapter.
- ✧ Unplug the AC adapter when it is not in use. Do not continue to charge a battery that is fully charged. Overcharging will shorten battery lifespan. If a fully charged battery is not used, it will discharge slowly, which does not affect its normal use.
- ✧ Do not use damaged or dysfunctional AC adapters and batteries.
- ✧ Properly dispose of and recycle batteries. Do not dispose of them as household garbage.

## Troubleshooting

Problem		Possible Cause & Solution
Type	Description	
Keyboard	Keyboard failure or incorrect response to any key entry.	Unreliable cable connection between keyboard and mainboard or keyboard malfunction. Please contact Newland after-sales service.
Battery	Battery indicator is OFF when charging.	Ensure the AC adapter is plugged in and properly connected.
	Noticeably short battery life.	<ol style="list-style-type: none"> <li>1. Check the battery level. If the battery is almost depleted, recharge it.</li> <li>2. Replace the battery if it is dysfunctional.</li> </ol>
	Fully charged battery is depleted after the terminal is switched on.	Replace the battery.
USB	USB communication failure.	<ol style="list-style-type: none"> <li>1. Ensure that the USB cable connections are secure.</li> <li>2. Ensure that there is no contaminant inside the Micro USB port.</li> <li>3. If the problem still remains, please contact the after-sales service center.</li> </ol>
LCD Screen	No display.	<ol style="list-style-type: none"> <li>1. Ensure the terminal is switched on.</li> <li>2. If the terminal is in suspend mode, press the Power key to wake it up.</li> <li>3. Check the battery level. If the battery is almost depleted, recharge it.</li> <li>4. Ensure that the battery is properly installed.</li> <li>5. Replace the battery if it is dysfunctional.</li> <li>6. If the problem still remains, please contact the after-sales service center.</li> </ol>
System	Cannot switch on.	<ol style="list-style-type: none"> <li>1. Check the battery level. If the battery is depleted, recharge it.</li> <li>2. Switch the terminal on after using the included AC adapter to connect it to a power outlet. If the problem disappears, then continue to charge the terminal. If the problem remains after charging the terminal for a while, replace the battery with a new one.</li> </ol>
	System halted.	<ol style="list-style-type: none"> <li>1. The problem may be caused by downloaded apps. Ensure that only reliable apps are used.</li> <li>2. The problem may be caused by a sudden or unexpected power loss. Perform a warm reset on the terminal by pushing the Reset button with a pin.</li> <li>3. If warm reset does not work, try cold reset to reset the terminal to factory default settings.</li> </ol>



**Newland EMEA**

+31 (0) 345 87 00 33

info@newland-id.com

**Newland D-A-CH**

+49 (0) 6182 82916-16

info@newland-id.de

**Newland UK**

+44 (0) 1442 212 020

sales@newland-id.co.uk

**Newland Nordic**

+46 (0) 708 847 767

nordic@newland-id.com

**Newland Ibérica**

+34 (0) 93 303 74 66

info@newland-id.es

**Newland France**

+31 (0) 345 87 00 33

france@newland-id.com

**Newland Middle East**

+31 (0) 345 87 00 33

middleeast@newland-id.com

**Newland South Africa**

+27 (0) 11 553 8010

info@newland-id.co.za

**Newland Italy**

+39 (0) 342 056 2227

italy@newland-id.com

**Newland Russia**

+31 (0) 345 87 00 33

russia@newland-id.com

**Newland Turkey & Iran**

+90 (0) 544 538 40 49

turkey@newland-id.com

iran@newland-id.com