

# MC3300R

RFID Mobile Computer

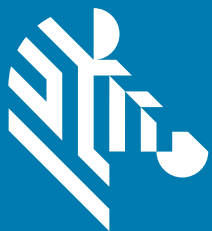
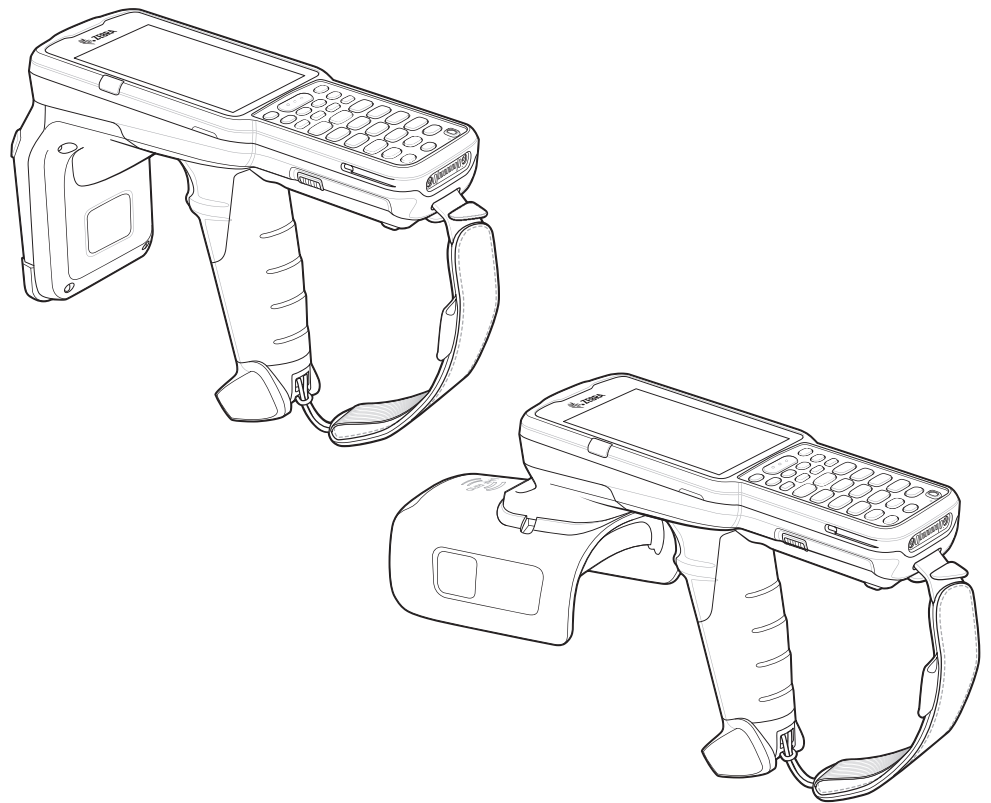

**ZEBRA**

**Integrator Guide  
Supplement**

---

## Copyright

ZEBRA and the stylized Zebra head are trademarks of Zebra Technologies Corporation, registered in many jurisdictions worldwide. All other trademarks are the property of their respective owners. ©2019 Zebra Technologies Corporation and/or its affiliates. All rights reserved.

COPYRIGHTS & TRADEMARKS: For complete copyright and trademark information, go to [www.zebra.com/copyright](http://www.zebra.com/copyright).

WARRANTY: For complete warranty information, go to [www.zebra.com/warranty](http://www.zebra.com/warranty).

END USER LICENSE AGREEMENT: For complete EULA information, go to [www.zebra.com/eula](http://www.zebra.com/eula).

## For Australia Only

For Australia Only. This warranty is given by Zebra Technologies Asia Pacific Pte. Ltd., 71 Robinson Road, #05-02/03, Singapore 068895, Singapore. Our goods come with guarantees that cannot be excluded under the Australia Consumer Law. You are entitled to a replacement or refund for a major failure and compensation for any other reasonably foreseeable loss or damage. You are also entitled to have the goods repaired or replaced if the goods fail to be of acceptable quality and the failure does not amount to a major failure.

Zebra Technologies Corporation Australia's limited warranty above is in addition to any rights and remedies you may have under the Australian Consumer Law. If you have any queries, please call Zebra Technologies Corporation at +65 6858 0722. You may also visit our website: [www.zebra.com](http://www.zebra.com) for the most updated warranty terms.

---

## Terms of Use

- Proprietary Statement

This manual contains proprietary information of Zebra Technologies Corporation and its subsidiaries ("Zebra Technologies"). It is intended solely for the information and use of parties operating and maintaining the equipment described herein. Such proprietary information may not be used, reproduced, or disclosed to any other parties for any other purpose without the express, written permission of Zebra Technologies.

- Product Improvements

Continuous improvement of products is a policy of Zebra Technologies. All specifications and designs are subject to change without notice.

- Liability Disclaimer

Zebra Technologies takes steps to ensure that its published Engineering specifications and manuals are correct; however, errors do occur. Zebra Technologies reserves the right to correct any such errors and disclaims liability resulting therefrom.

- Limitation of Liability

In no event shall Zebra Technologies or anyone else involved in the creation, production, or delivery of the accompanying product (including hardware and software) be liable for any damages whatsoever (including, without limitation, consequential damages including loss of business profits, business interruption, or loss of business information) arising out of the use of, the results of use of, or inability to use such product, even if Zebra Technologies has been advised of the possibility of such damages. Some jurisdictions do not allow the exclusion or limitation of incidental or consequential damages, so the above limitation or exclusion may not apply to you.

---

## Revision History

Changes to the original manual are listed below:

Change	Date	Description
-01 Rev A	11/2018	Initial release.
-02 Rev A	04/2019	Removed Scan-Scan-Write; OS updated to Android 8.1 Oreo.
-03 Rev A	10/2019	<ul style="list-style-type: none"><li>- Updated copyright statement.</li><li>- Added 123Scan for RFID.</li><li>- Removed Zebra RFID Mobile Application for Android chapter.</li><li>- Added reference to new RFID Demo Application Guide.</li></ul>

# Table of Contents

Copyright .....	2
For Australia Only .....	2
Terms of Use .....	2
Revision History .....	3
<b>About This Guide</b>	
Introduction .....	7
Configurations .....	7
Chapter Descriptions .....	10
Notational Conventions .....	10
Icon Conventions .....	10
Related Documents .....	11
Service Information .....	11
Provide Documentation Feedback .....	12
<b>Getting Started</b>	
Introduction .....	13
RFID Technology Overview .....	13
RFID Components .....	14
Tags .....	14
Antenna .....	14
Radio Module .....	14
LED Indications .....	14
Setting Up the MC3300R .....	15
<b>Accessories</b>	
Introduction .....	16
MC3300R Accessories .....	16
Compatibility .....	20
Battery Comparison .....	20
Battery Compatibility .....	20
1-Slot USB Charge Cradle .....	21
Charging the MC3300R Battery .....	21
Charging an MC3300R Spare Battery .....	22
Battery Charging in 1- Slot USB Charge Cradle .....	23



## Table of Contents

Charging Temperature .....	23
5-Slot Charge Only ShareCradle .....	24
Charging the MC3300R Battery .....	24
Battery Charging in the 5-Slot Charge Only ShareCradle .....	24
Charging Temperature .....	25
5-Slot Ethernet ShareCradle .....	26
Charging the MC3300R Battery .....	26
Battery Charging in the 5-Slot Ethernet ShareCradle .....	27
Charging Temperature .....	27
Daisy-chaining Ethernet ShareCradles .....	27
Ethernet Settings .....	28
Configuring Ethernet Proxy Settings .....	28
Configuring Ethernet Static IP Address .....	29
Establishing Ethernet Connection .....	30
LED Indicators .....	31
4-Slot ShareCradle with 4-Slot Battery Charger .....	32
Charging the MC3300R Battery .....	32
Charging Spare Batteries .....	33
Battery Charging in the 4-Slot ShareCradle with 4-Slot Battery Charger .....	33
Charging Temperature .....	33
4-Slot Ethernet ShareCradle with 4-Slot Battery Charger .....	34
Charging the MC3300R Battery .....	34
Charging Spare Batteries .....	35
Battery Charging in the 4-Slot Ethernet ShareCradle with 4-Slot Battery Charger .....	35
Charging Temperature .....	35
Daisy-chaining Ethernet Cradles .....	35
Ethernet Settings .....	36
Configuring Ethernet Proxy Settings .....	36
Configuring Ethernet Static IP Address .....	37
Establishing Ethernet Connection .....	38
LED Indicators .....	39
4-Slot Spare Battery Charger .....	39
Charging Spare Batteries .....	39
Battery Charging .....	40
Spare Battery Charging .....	40
Charging Temperature .....	41
20-Slot Spare Battery Charger .....	41
Charging Spare Batteries .....	41
Battery Charging .....	42
Spare Battery Charging .....	42
Charging Temperature .....	42
USB Charge Cable .....	43
Connecting the USB Charge Cable to Device .....	43
Connecting the USB Charge Cable to Host Computer .....	44
Main Battery Charging .....	45
Charging the Device .....	45
Main Battery Charging .....	45
Disconnecting the USB Charge Cable .....	46
MC33XX Charge Only Adapter .....	47
Adapter Installation .....	47
Charging Temperature .....	49

## Table of Contents

MC3300R Rubber Boot .....	50
Fabric Holster .....	51
Belt Strap .....	51
Shoulder Strap .....	51
Using the Belt Strap .....	52
Using the Shoulder Strap .....	53
Hand Strap .....	55
<b>Zebra RFID Mobile Application for Android</b>	
<b>RFID Manager</b>	
Introduction .....	58
Using the RFID Manager for Android .....	58
Connection Status .....	58
Reader Status .....	58
Client Application Status .....	60
RFID Regulatory .....	61
Settings .....	62
Firmware Update .....	64
Recovery Mode .....	66
RFID Manager Log .....	67
Exporting Log Files .....	67
<b>StageNow</b>	
Introduction .....	68
Creating Firmware Update Profile using StageNow .....	68
<b>Import RFID Manager Into StageNow</b>	
Introduction .....	73
Creating Firmware Update Profile using StageNow .....	73
<b>Troubleshooting</b>	
Introduction .....	80
Troubleshooting the MC3300R .....	80
<b>Technical Specifications</b>	
Introduction .....	81
MC3300R Technical Specifications .....	81

# About This Guide

---

## Introduction

The MC3300R RFID Mobile Computer Integrator Guide Supplement provides the unique set up and operating procedures for MC3300R RFID mobile computers. This guide is intended as a supplement to the MC33XX Integrator Guide, p/n MN-003136-xx. Procedures common to MC3300 products are addressed in the MC33XX Integrator Guide.



**NOTE:** Screens and windows pictured in this guide are samples and can differ from actual screens.

---

## Configurations

**Table 1** MC3300R Configurations

Configuration	Description
MC333R-GI2HG4US	MC3330R UHF RFID GUN, CIRCULAR ANTENNA, 802.11 A/B/G/N/AC, SE4750SR 2D IMAGER W/ LED AIMER, 29 KEY, 2X BATTERY, GMS, 4GB RAM / 32GB ROM, FCC BANDS
MC339R-GE2HG4US	MC3390R UHF RFID GUN, LINEAR ANTENNA, 802.11 A/B/G/N/AC, SE4850 EXTENDED RANGE 2D IMAGER, 29 KEY, 2X BATTERY, GMS, 4GB RAM / 32GB ROM, FCC BANDS
MC339R-GF2HG4US	MC3390R UHF RFID GUN, LINEAR ANTENNA, 802.11 A/B/G/N/AC, SE4750MR 2D IMAGER, 29 KEY, 2X BATTERY, GMS, 4GB RAM / 32GB ROM, FCC BANDS
MC333R-GI2HG4EU	MC3330R UHF RFID GUN, CIRCULAR ANTENNA, 802.11 A/B/G/N/AC, SE4750SR 2D IMAGER W/ LED AIMER, 29 KEY, 2X BATTERY, GMS, 4GB RAM / 32GB ROM, ETSI BANDS
MC339R-GE2HG4EU	MC3390R UHF RFID GUN, LINEAR ANTENNA, 802.11 A/B/G/N/AC, SE4850 EXTENDED RANGE 2D IMAGER, 29 KEY, 2X BATTERY, GMS, 4GB RAM / 32GB ROM, ETSI BANDS
MC339R-GF2HG4EU	MC3390R UHF RFID GUN, LINEAR ANTENNA, 802.11 A/B/G/N/AC, SE4750MR 2D IMAGER, 29 KEY, 2X BATTERY, GMS, 4GB RAM / 32GB ROM, ETSI BANDS

## About This Guide

**Table 1** MC3300R Configurations

Configuration	Description
MC333R-GI2HA4IL	MC3330R UHF RFID GUN, CIRCULAR ANTENNA, 802.11 A/B/G/N/AC, SE4750SR 2D IMAGER W/ LED AIMER, 29 KEY, 2X BATTERY, AOSP, 4GB RAM / 32GB ROM, ISRAEL ONLY
MC333R-GI4HG4IN	MC3330R UHF RFID GUN, CIRCULAR ANTENNA, 802.11 A/B/G/N/AC, SE4750SR 2D IMAGER W/ LED AIMER, 47 KEY, 2X BATTERY, GMS, 4GB RAM / 32GB ROM, INDIA ONLY
MC339R-GF4HG4IN	MC3390R UHF RFID GUN, LINEAR ANTENNA, 802.11 A/B/G/N/AC, SE4750MR 2D IMAGER, 47 KEY, 2X BATTERY, GMS, 4GB RAM / 32GB ROM, INDIA ONLY
MC333R-GI4HG4JP	MC3330R UHF RFID GUN, CIRCULAR ANTENNA, 802.11 A/B/G/N/AC, SE4750SR 2D IMAGER W/ LED AIMER, 47 KEY, 2X BATTERY, GMS, 4GB RAM / 32GB ROM, JAPAN ONLY
MC333R-GI4HG4WR	MC3330R UHF RFID GUN, CIRCULAR ANTENNA, 802.11 A/B/G/N/AC, SE4750SR 2D IMAGER W/ LED AIMER, 47 KEY, 2X BATTERY, GMS, 4GB RAM / 32GB ROM, WORLDWIDE (902-928 MHZ EXCL. NA)
MC339R-GE4HG4WR	MC3390R UHF RFID GUN, LINEAR ANTENNA, 802.11 A/B/G/N/AC, SE4850 EXTENDED RANGE 2D IMAGER, 47 KEY, 2X BATTERY, GMS, 4GB RAM / 32GB ROM, WORLDWIDE (902-928 MHZ EXCL. NA)
MC339R-GF4HG4WR	MC3390R UHF RFID GUN, LINEAR ANTENNA, 802.11 A/B/G/N/AC, SE4750MR 2D IMAGER, 47 KEY, 2X BATTERY, GMS, 4GB RAM / 32GB ROM, WORLDWIDE (902-928 MHZ EXCL. NA)
MC333R-GI3HG4US	MC3330R UHF RFID GUN, CIRCULAR ANTENNA, 802.11 A/B/G/N/AC, SE4750SR 2D IMAGER W/ LED AIMER, 38 KEY, 2X BATTERY, GMS, 4GB RAM / 32GB ROM, FCC BANDS
MC339R-GE3HG4US	MC3390R UHF RFID GUN, LINEAR ANTENNA, 802.11 A/B/G/N/AC, SE4850 EXTENDED RANGE 2D IMAGER, 38 KEY, 2X BATTERY, GMS, 4GB RAM / 32GB ROM, FCC BANDS
MC339R-GF3HG4US	MC3390R UHF RFID GUN, LINEAR ANTENNA, 802.11 A/B/G/N/AC, SE4750MR 2D IMAGER, 38 KEY, 2X BATTERY, GMS, 4GB RAM / 32GB ROM, FCC BANDS
MC333R-GI4HG4US	MC3330R UHF RFID GUN, CIRCULAR ANTENNA, 802.11 A/B/G/N/AC, SE4750SR 2D IMAGER W/ LED AIMER, 47 KEY, 2X BATTERY, GMS, 4GB RAM / 32GB ROM, FCC BANDS
MC339R-GE4HG4US	MC3390R UHF RFID GUN, LINEAR ANTENNA, 802.11 A/B/G/N/AC, SE4850 EXTENDED RANGE 2D IMAGER, 47 KEY, 2X BATTERY, GMS, 4GB RAM / 32GB ROM, FCC BANDS
MC339R-GF4HG4US	MC3390R UHF RFID GUN, LINEAR ANTENNA, 802.11 A/B/G/N/AC, SE4750MR 2D IMAGER, 47 KEY, 2X BATTERY, GMS, 4GB RAM / 32GB ROM, FCC BANDS
MC333R-GI4HA4CN	MC3330R UHF RFID GUN, CIRCULAR ANTENNA, 802.11 A/B/G/N/AC, SE4750SR 2D IMAGER W/ LED AIMER, 47 KEY, 2X BATTERY, AOSP, 4GB RAM / 32GB ROM, CHINA ONLY

**Table 1** MC3300R Configurations

Configuration	Description
MC339R-GE4HA4CN	MC3390R UHF RFID GUN, LINEAR ANTENNA, 802.11 A/B/G/N/AC, SE4850 EXTENDED RANGE 2D IMAGER, 47 KEY, 2X BATTERY, AOSP, 4GB RAM / 32GB ROM, CHINA ONLY
MC339R-GF4HA4CN	MC3390R UHF RFID GUN, LINEAR ANTENNA, 802.11 A/B/G/N/AC, SE4750MR 2D IMAGER, 47 KEY, 2X BATTERY, AOSP, 4GB RAM / 32GB ROM, CHINA ONLY
MC333R-GI3HG4EU	MC3330R UHF RFID GUN, CIRCULAR ANTENNA, 802.11 A/B/G/N/AC, SE4750SR 2D IMAGER W/ LED AIMER, 38 KEY, 2X BATTERY, GMS, 4GB RAM / 32GB ROM, ETSI BANDS
MC339R-GE3HG4EU	MC3390R UHF RFID GUN, LINEAR ANTENNA, 802.11 A/B/G/N/AC, SE4850 EXTENDED RANGE 2D IMAGER, 38 KEY, 2X BATTERY, GMS, 4GB RAM / 32GB ROM, ETSI BANDS
MC339R-GF3HG4EU	MC3390R UHF RFID GUN, LINEAR ANTENNA, 802.11 A/B/G/N/AC, SE4750MR 2D IMAGER, 38 KEY, 2X BATTERY, GMS, 4GB RAM / 32GB ROM, ETSI BANDS
MC333R-GI4HG4EU	MC3330R UHF RFID GUN, CIRCULAR ANTENNA, 802.11 A/B/G/N/AC, SE4750SR 2D IMAGER W/ LED AIMER, 47 KEY, 2X BATTERY, GMS, 4GB RAM / 32GB ROM, ETSI BANDS
MC339R-GE4HG4EU	MC3390R UHF RFID GUN, LINEAR ANTENNA, 802.11 A/B/G/N/AC, SE4850 EXTENDED RANGE 2D IMAGER, 47 KEY, 2X BATTERY, GMS, 4GB RAM / 32GB ROM, ETSI BANDS
MC339R-GF4HG4EU	MC3390R UHF RFID GUN, LINEAR ANTENNA, 802.11 A/B/G/N/AC, SE4750MR 2D IMAGER, 47 KEY, 2X BATTERY, GMS, 4GB RAM / 32GB ROM, ETSI BANDS

---

## Chapter Descriptions

Topics covered in this guide are as follows:

- [Getting Started](#) provides information on RFID technology and MC3300R LED indications.
- [Zebra RFID Mobile Application for Android](#) for Android refers to the new 123RFID Mobile Application.
- [Accessories](#) describes the available accessories and how to use them with MC3300R devices.
- [RFID Manager](#) describes how to configure the Zebra RFID Manager Application for MC3300R devices.
- [Troubleshooting](#) describes cleaning, maintenance, and troubleshooting procedures.
- [StageNow](#) provides a reference to access this easy Wizard-based tool that allows even complex Staging profiles to become simple to create.
- [Import RFID Manager Into StageNow](#) provides instructions necessary to generate an RFID Firmware update profile and import RFID CSP plug-in into the StageNow application.
- [Troubleshooting](#) provides troubleshooting solutions for potential problems during MC3300R operation.
- [Technical Specifications](#) provides the technical specifications for MC3300R devices.

---

## Notational Conventions

The following conventions are used in this document:

- “RFID mobile computer” refers to MC3300R RFID Mobile Computers.
- Bold text is used to highlight the following:
  - Dialog box, window and screen names
  - Drop-down list and list box names
  - Check box and radio button names
  - Icons on a screen
  - Key names on a keypad
  - Button names on a screen.
- Bullets (•) indicate:
  - Action items
  - Lists of alternatives
  - Lists of required steps that are not necessarily sequential
- Sequential lists (e.g., those that describe step-by-step procedures) appear as numbered lists.

---

## Icon Conventions

The documentation set is designed to give the reader more visual clues. The following graphic icons are used throughout the documentation set. These icons and their associated meanings are described below.



**NOTE:** NOTE contains information more important than the surrounding text, such as exceptions or preconditions. They also refer the reader elsewhere for additional information, remind the reader how to complete an action (when it is not part of the current procedure, for instance), or tell the reader where something is located on the screen. There is no warning level associated with a note.



**CAUTION:** The word CAUTION with the associated safety icon implies information that, if disregarded, may result in minor or moderate injury, or serious product damage.



**WARNING:** The word WARNING with the associated safety icon implies information that, if disregarded, could result in death or serious injury, or serious product damage.

---

## Related Documents

The following documents provide more information about the reader.

- MC3330R Quick Reference Guide, p/n MN-003182-xx.
- MC3390R Quick Reference Guide, p/n MN-003207-xx.
- Zebra RFID SDK for Android Developer Guide, p/n MN-003158-xx.
- 123RFID Mobile Application User Guide, p/n MN-003765-xx.

For the latest version of this guide and all guides, go to: [zebra.com/support](http://zebra.com/support).

---

## Service Information

If you have a problem with your equipment, contact Zebra Support Center for your region. Contact information is available at: [www.zebra.com/support](http://www.zebra.com/support).

When contacting the Zebra Support Center, please have the following information available:

- Serial number of the unit (found on manufacturing label)
- Model number or product name (found on manufacturing label)
- Software type and version number.

**Figure 1** Manufacturing Label

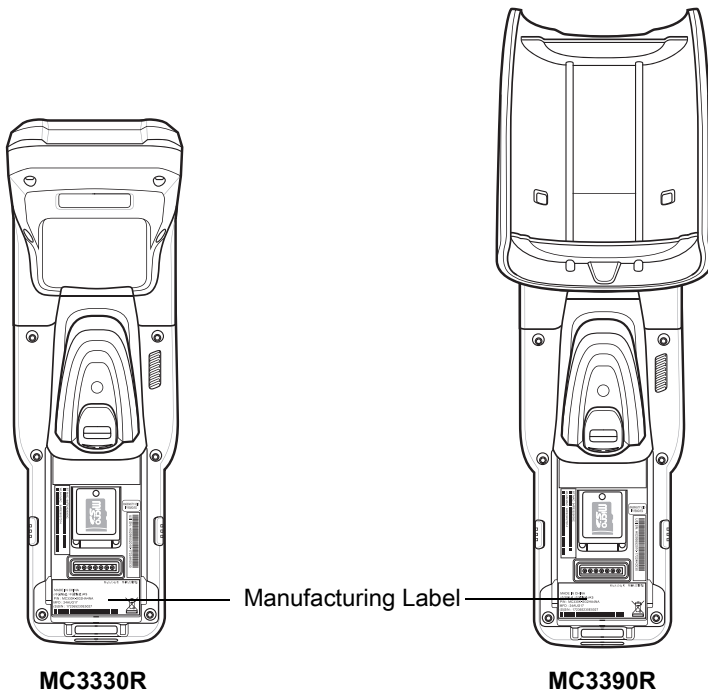

Zebra responds to calls by email or telephone within the time limits set forth in support agreements.

If the problem cannot be solved by the Zebra Support Center, the user may need to return the equipment for servicing and will be given specific directions. Zebra is not responsible for any damages incurred during shipment if the approved shipping container is not used. Shipping the units improperly can possibly void the warranty.

Remove the microSD card from the device before shipping for service.

If you purchased your product from a Zebra business partner, contact that business partner for support.

---

## Provide Documentation Feedback

If you have comments, questions, or suggestions about this guide, send an email to [EVM-Techdocs@zebra.com](mailto:EVM-Techdocs@zebra.com).



# Getting Started

---

## Introduction

This chapter provides an overview of RFID technology and components, and describes the MC3300R RFID mobile computer LED indications.

---

## RFID Technology Overview

RFID (Radio Frequency Identification) is an advanced automatic identification (Auto ID) technology that uses radio frequency signals to identify tagged items. An RFID tag contains a circuit that can store data. This data may be pre-encoded or can be encoded in the field. The tags come in a variety of shapes and sizes.

To read a tag, the mobile computer sends out radio frequency waves using its integrated antenna. This RF field powers and charges the tags, which are tuned to receive radio waves. The tags use this power to modulate the carrier signal. The reader interprets the modulated signal and converts the data to a format for computer storage. The computer application translates the data into an understandable format.

**Figure 2** RFID System Elements

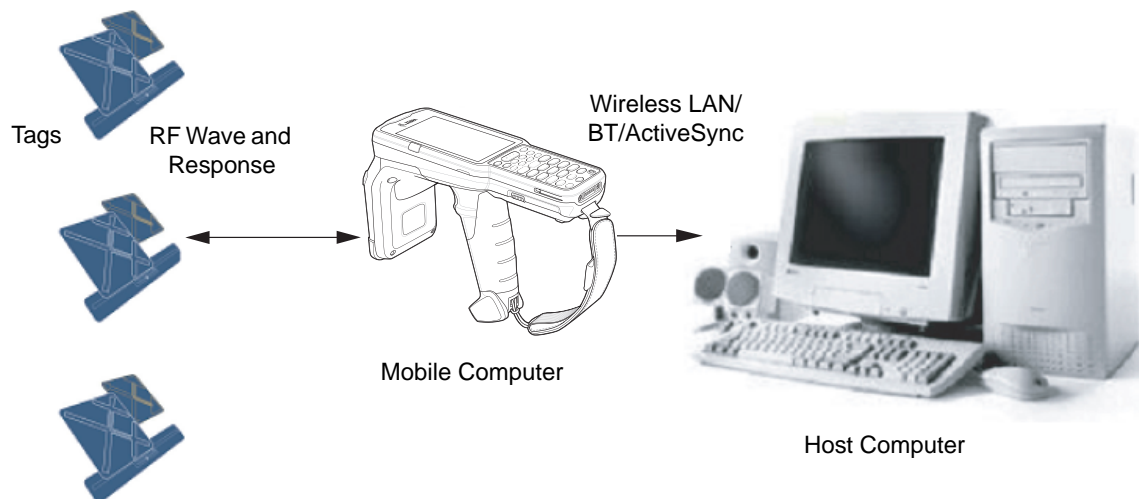

## RFID Components

Zebra RFID solutions offer low cost, long read range, and a high read rate. These features provide real time end-to-end visibility of products and assets in the factory, distribution center, retail outlet, or other facility. The MC3300R RFID system consists of the following components:

Silicon-based RFID tags that attach to retail products, vehicles, trailers, containers, pallets, boxes, etc.

An integrated antenna that supports applications such as item level tracking and asset tracking.

An embedded radio module that powers and communicates with tags for data capture and provides host connectivity for data migration.

## Tags

Tags contain embedded chips that store unique information. Available in various shapes and sizes, tags, often called transponders, receive and respond to data requests. Tags require power to send data.

There are several categories of tags based on the protocol they support, read/write memory, and power options:

Active RFID tags are powered by internal light-weight batteries, and also use these batteries to broadcast radio waves to the reader.

Semi-passive RFID tags are also powered by internal light-weight batteries, but draw broadcasting power from the reader.

Passive RFID tags are powered by a reader-generated RF field. These tags are much lighter and less expensive than active tags, and are typically applied to less expensive goods.

## Antenna

Antennas transmit and receive radio frequency signals.

## Radio Module

The radio module communicates with the tags and transfers the data to a host computer. It also provides features such as filtering, CRC check, and tag writing. The MC3300R RFID mobile computer supports standard RFID tags as described by EPCGlobal™ Class 1 Gen2 protocol.

---

## LED Indications

The Charge LED Indicator indicates the charge status.

**Table 2** LED Charge Indicators

Status	Indications
Off	The battery is not charging. The battery is not inserted correctly in the cradle or connected to a power source. Cradle is not powered.
Green Fast (20 ms)	Tag read and/or write.

Status	Indications
Green Slow (200 ms)	Firmware update in progress.
Red (5 s); Green Slow (200 ms)	Firmware recovery mode followed by firmware update.

---

## Setting Up the MC3300R

To start using the MC3300R for the first time:

- Ensure the battery is installed
- Charge the MC3300R
- Power on the MC3300R
- Remove MC3300R from charger
- Set the region and power level (using the RFID Manager Application, Demo Application, or the partner application).

# Accessories

---

## Introduction

This chapter provides information on using the accessories for the device.

---

## MC3300R Accessories

The table below lists the accessories available for the MC3300R.

**Table 3** MC3300R Accessories

Accessory	Part Number	Description
<b>Cradles</b>		
1-Slot USB Charge Cradle with Spare Battery Charger	CRD-MC33-2SUCHG-01	Charges the MC3300R main battery and a spare battery, and synchronizes the MC3300R with a host computer through a USB connection. Requires power supply (PWR-BGA12V50W0WW), DC line cord (CBL-DC-388A1-01) and a country specific grounded AC line cord.
5-Slot Charge Only ShareCradle	CRD-MC33-5SCHG-01	Charge only. Charges up to five MC3300Rs. Requires power supply (PWR-BGA12V108W0WW), DC line cord (CBL-DC-381A1-01) and a country specific grounded AC line cord.
5-Slot Ethernet ShareCradle	CRD-MC33-5SETH-01	Charges up to five MC3300Rs and provides Ethernet communication for up to five devices. Requires power supply (PWR-BGA12V108W0WW), DC line cord (CBL-DC-381A1-01) and a country specific grounded AC line cord.

**Table 3** MC3300R Accessories (Continued)

Accessory	Part Number	Description
4-Slot Charge ShareCradle with 4-Slot Battery Charger	CRD-MC33-4SC4BC-01	Charge only. Charges up to four MC3300Rs and up to four spare batteries. Requires power supply (PWR-BGA12V108W0WW), DC line cord (CBL-DC-381A1-01) and a country specific grounded AC line cord.
4-Slot Ethernet ShareCradle with 4-Slot Battery Charger	CRD-MC33-4SE4BC-01	Charges up to four MC3300Rs and up to four spare batteries and provides Ethernet communication for up to four MC3300Rs. Requires power supply (PWR-BGA12V108W0WW), DC line cord (CBL-DC-381A1-01) and a country specific grounded AC line cord.
<b>Chargers</b>		
4-Slot Spare Battery Charger	SAC-MC33-4SCHG-01	Charges up to four MC3300R spare batteries. Requires power supply (PWR-BGA12V50W0WW), DC line cord (CBL-DC-388A1-01) and a country specific grounded AC line cord.
20-Slot Spare Battery Charger	SAC-MC33-20SCHG-01	Charges up to 20 MC3300R spare batteries. Requires power supply (PWR-BGA12V108W0WW), DC line cord (CBL-DC-381A1-01) and a country specific grounded AC line cord.
Power Supply	PWR-BGA12V50W0WW	Level VI power supply. Provides 12 VDC, 2.5A power to the 1-Slot USB Charge Cradle and the 4-Slot Spare Battery Charger. Requires a DC line cord (CBL-DC-388A1-01) and a country specific grounded AC line cord.
Power Supply	PWR-BGA12V108W0W W	Level VI power supply. Provides 12 VDC, 2.5A power to the 5-Slot Charge Only Cradle, 5-Slot Ethernet Cradle, 5-Slot Charge Cradle with 4-Slot Battery Charger, 5-Slot Ethernet Cradle with 4-Slot Battery Charger and 20-Slot Battery Charger. Requires a DC line cord (CBL-DC-381A1-01) and a country specific grounded AC line cord.

## Accessories

**Table 3** MC3300R Accessories (Continued)

Accessory	Part Number	Description
Power Supply	PWR-WUA5V12W0US	Wall adapter; Provides 12 VDC, 2.5A power to the USB Charge Cable. Includes plug adapter for use in the United States.
Power Supply	PWR-WUA5V12W0GB	Provides 12 VDC, 2.5A power to the USB Charge Cable. Includes plug adapter for use in the European Union.
Power Supply	PWR-WUA5V12W0EU	Provides 12 VDC, 2.5A power to the USB Charge Cable. Includes plug adapter for use in the United Kingdom.
Power Supply	PWR-WUA5V12W0AU	Provides 12 VDC, 2.5A power to the USB Charge Cable. Includes plug adapter for use in Australia.
Power Supply	PWR-WUA5V12W0CN	Provides 12 VDC, 2.5A power to the USB Charge Cable. Includes plug adapter for use in China.
Power Supply	PWR-WUA5V12W0IN	Provides 12 VDC, 2.5A power to the USB Charge Cable. Includes plug adapter for use in India.
US AC Line Cord	23844-00-00R	Provides power to 3-wire power supplies PWR-BGA12V50W0WW and PWR-BGA12V108W0WW.
DC Line Cord	CBL-DC-381A1-01	Provides power from the power supply (PWR-BGA12V108W0WW) to the 5-Slot Charge Only Cradle, 5-Slot Ethernet Cradle, 5-Slot Charge Cradle with 4-Slot Battery Charger, 5-Slot Ethernet Cradle with 4-Slot Battery Charger and 20-Slot Battery Charger.
DC Line Cord	CBL-DC-388A1-01	Provides power from the power supply (PWR-BGA12V150W0WW) to the 1-Slot USB Charge Cradle and 4-Slot Battery Charger.
<b>Cables</b>		
USB Charge Cable	CBL-MC33-USBCHG-01	Provides power and/or communication over USB to the device. Requires wall adapter/power supply PWR-WUA5V12W0xx.
1-Slot Cradle USB Cable	25-124330-01R	Provides USB communication through the 1-Slot USB cradle to the host computer.

## Accessories

**Table 3** MC3300R Accessories (Continued)

Accessory	Part Number	Description
<b>Miscellaneous</b>		
Cradle Adapter	ADP-MC33-CRDCUP-01	MC3300R Charge Only Adapter for backwards compatibility with MC32 cradles. Works with MC32N0 1-Slot USB Cradle, 4-Slot Charge Only Cradle, and 4-Slot Ethernet Cradles.
5200 mAh Battery (Extended PowerPrecision+)	BTRY-MC33-52MA-01	Replacement extended capacity battery.
	BTRY-MC33-52MA-10	Replacement extended capacity battery (10-pack).
	BTRY-MC33-52MA-IN	Replacement extended capacity battery (India).
Hand Strap	SG-MC33-HDSTPG-01	Replacement hand strap for the MC3300R. Hand strap loop holds an optional stylus (SG-TC7X-STYLUS-03).
Fabric Holster	SG-MC3021212-01R	Provides a soft, clip on holster and a shoulder strap for the MC3300R.
Shoulder Strap	58-40000-007R	Universal shoulder strap.
Belt	11-08062-02R	Belt for fabric holster.
Rubber Boot	SG-MC33-RBTG-02 SG-MC33-RBTG-03	Provides additional protection for wear and tear of the MC3300R.
Tempered Glass Screen Protector	MISC-MC33-SCRN-01	Provides additional protection for display (5-pack).
Stylus and Tether	SG-TC7X-STYLUS-03	Conductive carbon-filled stylus for capacitive touch panel; includes coiled tether (3-pack).

## Compatibility

The table below displays compatibility between MC3300R devices and MC32N0 mobile computers and accessories.

**Table 4** Compatibility

	MC3300R PP+ Batteries	MC32N0 PP Batteries	MC3300R Cradles	MC32N0 Cradles	MC3300R Battery Charger	MC32N0 Battery Charger
MC3300R mobile computer	Yes	Yes	Yes	Yes w/adapter	N/A	N/A
MC32N0 mobile computer	No	Yes	No	Yes	N/A	N/A
MC3300R PP+ Battery	N/A	N/A	Yes	No	Yes	No
MC32N0 PP Battery	N/A	N/A	Yes	Yes	Yes	Yes

- MC3300R mobile computers are compatible with all batteries (MC3300R PowerPrecision+ and MC32N0 PowerPrecision).
- MC3300R mobile computer is compatible with all cradles.  
An additional adapter is needed to use any MC32N0 cradle slot, which provides charge only, no communication.
- MC3300R battery charger slots are compatible with all batteries (MC3300R PowerPrecision+ and MC32N0 PowerPrecision).
- MC32N0 mobile computers are not compatible with MC3300R cradles.

## Battery Comparison

The table below displays a comparison of the MC3300R batteries with the MC32N0 batteries.

**Table 5** Battery Comparison

Feature	MC32N0	MC3300R
Battery Type	PowerPrecision	PowerPrecision+
Includes Zebra and PowerPrecision+ recessed logos	No	Yes
Back Label	Grey	Blue

## Battery Compatibility

- MC3300R PowerPrecision+ batteries are compatible with all MC3300R mobile computers and accessories.
- MC3300R PowerPrecision+ batteries are not compatible with MC32N0 mobile computers and accessories.
- MC32N0 PowerPrecision batteries are compatible with all MC32N0 mobile computers and accessories.
- MC32N0 PowerPrecision batteries are compatible with all MC3300R mobile computers and accessories.



## 1-Slot USB Charge Cradle

The 1-Slot USB Charge Cradle:

- Provides 9 VDC power for charging the mobile computer and charging the battery.
- Provides 4.2 VDC power to charge the spare battery.
- Provides a USB port for data communication between the mobile computer and a host computer or other USB devices (e.g., a printer).
- Synchronizes information between the mobile computer and a host computer. With customized or third party software, it can also synchronize the mobile computer with corporate databases.
- Compatible with the following batteries:
  - MC3300R 5200 mAh PowerPrecision+ extended battery.
  - MC32N0 5200 mAh PowerPrecision extended battery.

**Figure 3** 1-Slot USB Charge Cradle Setup

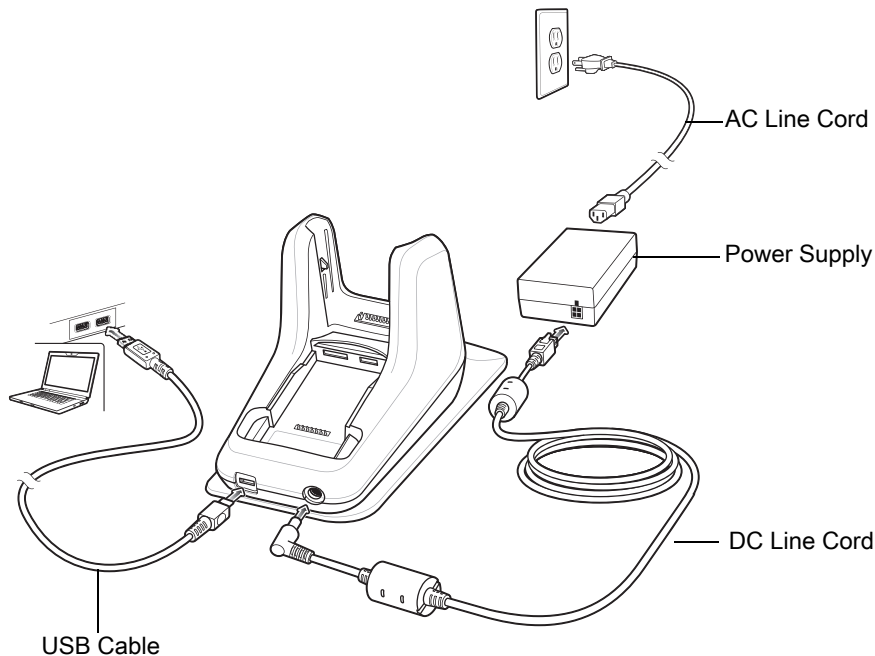

## Charging the MC3300R Battery



**NOTE:** To function properly, remove the lower part of the rubber boot or the entire rubber boot before placing in a charging cradle.

1. Ensure that the cradle is connected to power.
2. Slide the mobile computer into the slot in the cradle. The mobile computer Charge LED Indicator, indicates the mobile computer battery charging status. For charging status, see [Table 6 on page 23](#)

**Figure 4** MC3300R Battery Charging

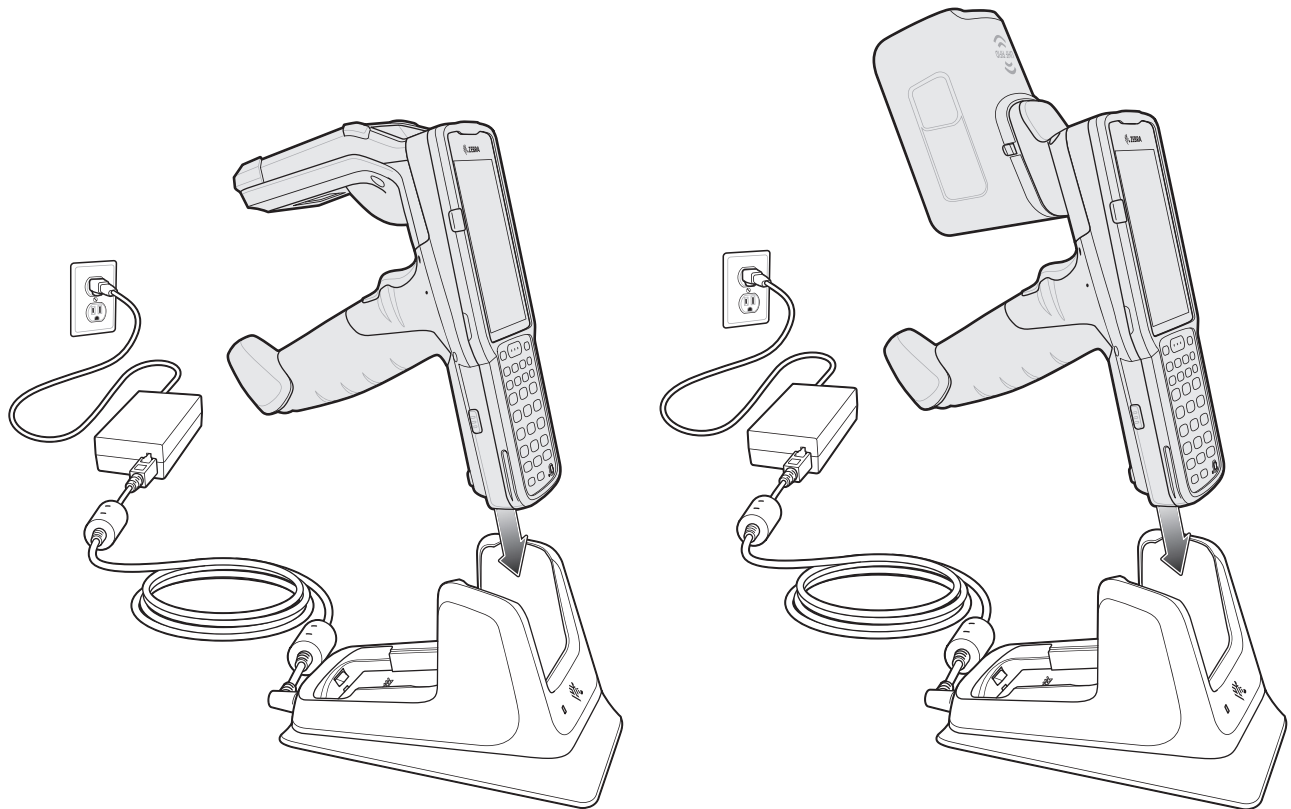

3. Gently press down on the device to ensure proper contact.
4. When charging is complete, remove the mobile computer from the cradle slot.

## Charging an MC3300R Spare Battery

1. Ensure that the cradle is connected to power.
2. Insert the spare battery into the cradle, bottom first, and pivot the top of the battery down onto the contact pins.

**Figure 5** MC3300R Spare Battery Charging

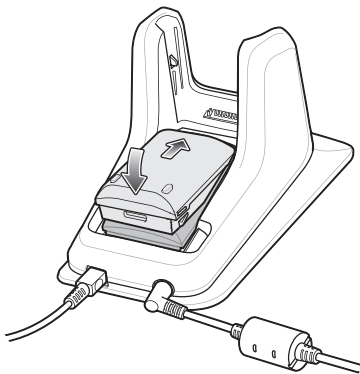

3. Gently press down on the battery to ensure proper contact.  
The Spare Battery Charging LED on the front of the cradle indicates the spare battery charging status.
4. When charging is complete, lift the battery out of the slot.

## Battery Charging in 1- Slot USB Charge Cradle

The 1-Slot USB charge cradle charges the MC3300R's main battery and a spare battery simultaneously.

The MC3300R's Charge LED indicates the status of the battery charging in the MC3300R. See [Table 6](#) for charging status indications.

The spare battery charging LED on the cradle indicates the status of the spare battery charging in the cradle. See below for charging status indications.

**Table 6** Spare Battery LED Charging Indicators

Spare Battery LED (on cradle)	Indication
Off	<ul style="list-style-type: none"> <li>The battery is not charging.</li> <li>The battery is not inserted correctly in the cradle or connected to a power source.</li> <li>Cradle is not powered.</li> </ul>
Solid Amber	<ul style="list-style-type: none"> <li>Battery is charging.</li> </ul>
Solid Green	<ul style="list-style-type: none"> <li>Battery charging is complete.</li> </ul>
Fast Blinking Red 2 blinks/second	Charging error, e.g.: <ul style="list-style-type: none"> <li>Temperature is too low or too high.</li> <li>Charging has gone on too long without completion (typically eight hours).</li> </ul>
Solid Red	<ul style="list-style-type: none"> <li>Spare battery is charging and battery is at the end of useful life.</li> <li>Charging complete and battery is at the end of useful life.</li> </ul>

The MC3300R 5200 mAh PowerPrecision+ extended battery charges from 0% to 90% in less than 3.8 hours at room temperature.

The MC32N0 5200 mAh PowerPrecision extended battery charges from 0% to 90% in less than 5.5 hours at room temperature.

### Charging Temperature

Charge batteries in temperatures from 0 °C to 40 °C (32 °F to 104 °F). Charging is intelligently controlled by the MC3300R.

To accomplish this, for small periods of time, the MC3300R or cradle alternately enables and disables battery charging to keep the battery at acceptable temperatures. The MC3300R or cradle indicates when charging is disabled due to abnormal temperatures via its LED.

## 5-Slot Charge Only ShareCradle

The 5-Slot Charge Only ShareCradle:

- Provides 9 VDC power for operating the mobile computer and charging the battery.
- Simultaneously charges up to five mobile computers.
- Compatible with devices using the following batteries:
  - MC3300R 5200 mAh PowerPrecision+ extended battery.
  - MC32N0 5200 mAh PowerPrecision extended battery.

**Figure 6** 5-Slot Charge Only ShareCradle Setup

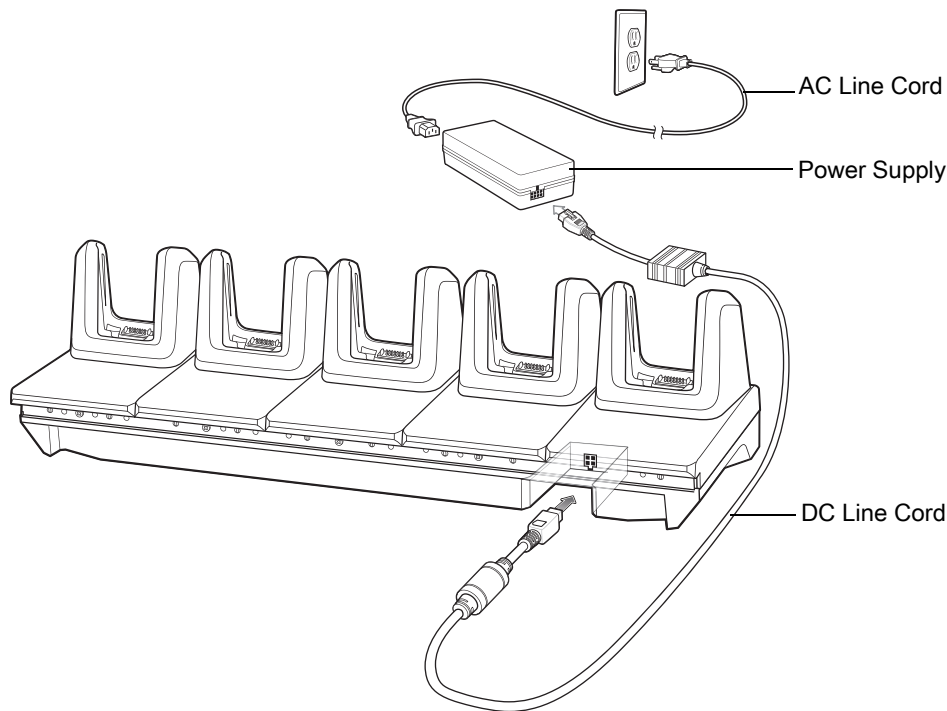

## Charging the MC3300R Battery



**NOTE:** To function properly, remove the lower part of the rubber boot or the entire rubber boot before placing in a charging cradle.

1. Ensure that the cradle is connected to power.
2. Slide the mobile computer into the slot in the cradle. The mobile computer Charge LED Indicator, indicates the mobile computer battery charging status.
3. Gently press down on the device to ensure proper contact.
4. When charging is complete, remove the mobile computer from the cradle slot.

## Battery Charging in the 5-Slot Charge Only ShareCradle

The MC3300R's Charge LED indicates the status of the battery charging in the MC3300R. See [Table 10 on page 42](#) for charging status indications.

The MC3300R 5200 mAh PowerPrecision+ extended battery charges from 0% to 90% in less than 3.8 hours at room temperature.

The MC32N0 5200 mAh PowerPrecision extended battery charges from 0% to 90% in less than 5.5 hours at room temperature.

### **Charging Temperature**

Charge batteries in temperatures from 0 °C to 40 °C (32 °F to 104 °F). Charging is intelligently controlled by the MC3300R.

To accomplish this, for small periods of time, the MC3300R or cradle alternately enables and disables battery charging to keep the battery at acceptable temperatures. The MC3300R or cradle indicates when charging is disabled due to abnormal temperatures via its LED.

## 5-Slot Ethernet ShareCradle

The 5-Slot Ethernet ShareCradle:

- Provides 9 VDC power for operating the mobile computer and charging the battery.
- Simultaneously charges up to five mobile computers.
- Compatible with devices using the following batteries:
  - MC3300R 5200 mAh PowerPrecision+ extended battery.
  - MC32N0 5200 mAh PowerPrecision extended battery.

**Figure 7** 5-Slot Ethernet ShareCradle Setup

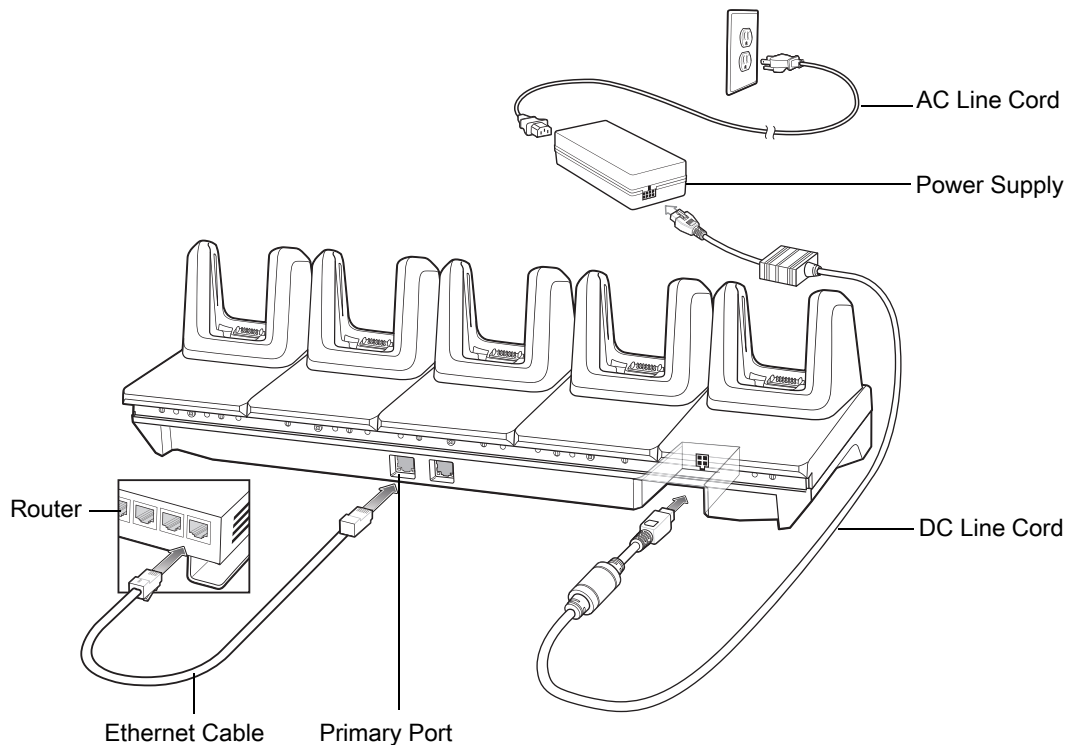

## Charging the MC3300R Battery



**NOTE:** To function properly, remove the lower part of the rubber boot or the entire rubber boot before placing in a charging cradle.

1. Ensure that the cradle is connected to power.
2. Slide the mobile computer into the slot in the cradle. The mobile computer amber Charge LED Indicator, indicates the mobile computer battery charging status.
3. Gently press down on the device to ensure proper contact.
4. When charging is complete, remove the mobile computer from the cradle slot.

## Battery Charging in the 5-Slot Ethernet ShareCradle

The MC3300R's Charge LED indicates the status of the battery charging in the MC3300R. See [Table 10 on page 42](#) for charging status indications.

The MC3300R 5200 mAh PowerPrecision+ extended battery charges from 0% to 90% in less than 3.8 hours at room temperature.

The MC32N0 5200 mAh PowerPrecision extended battery charges from 0% to 90% in less than 5.5 hours at room temperature.

### Charging Temperature

Charge batteries in temperatures from 0 °C to 40 °C (32 °F to 104 °F). Charging is intelligently controlled by the MC3300R.

To accomplish this, for small periods of time, the MC3300R or cradle alternately enables and disables battery charging to keep the battery at acceptable temperatures. The MC3300R or cradle indicates when charging is disabled due to abnormal temperatures via its LED.

## Daisy-chaining Ethernet ShareCradles

Daisy-chain up to ten 5-Slot Ethernet ShareCradles to connect several cradles to an Ethernet network. Use either a straight or crossover cable. Daisy-chaining should not be attempted when the main Ethernet connection to the first cradle is 10 Mbps or throughput issues are likely to occur.

To daisy-chain 5-Slot Ethernet ShareCradles:

1. Connect power to each 5-Slot Ethernet ShareCradle.
2. Connect an Ethernet cable to one of the ports on the switch and the other end to the Primary Port of the first cradle.
3. Connect an Ethernet cable to the Secondary port of the first cradle.
4. Connect the other end of the Ethernet cable to the Primary port of the next 5-Slot Ethernet ShareCradle.

**Figure 8** Daisy-chaining 5-Slot Ethernet ShareCradles

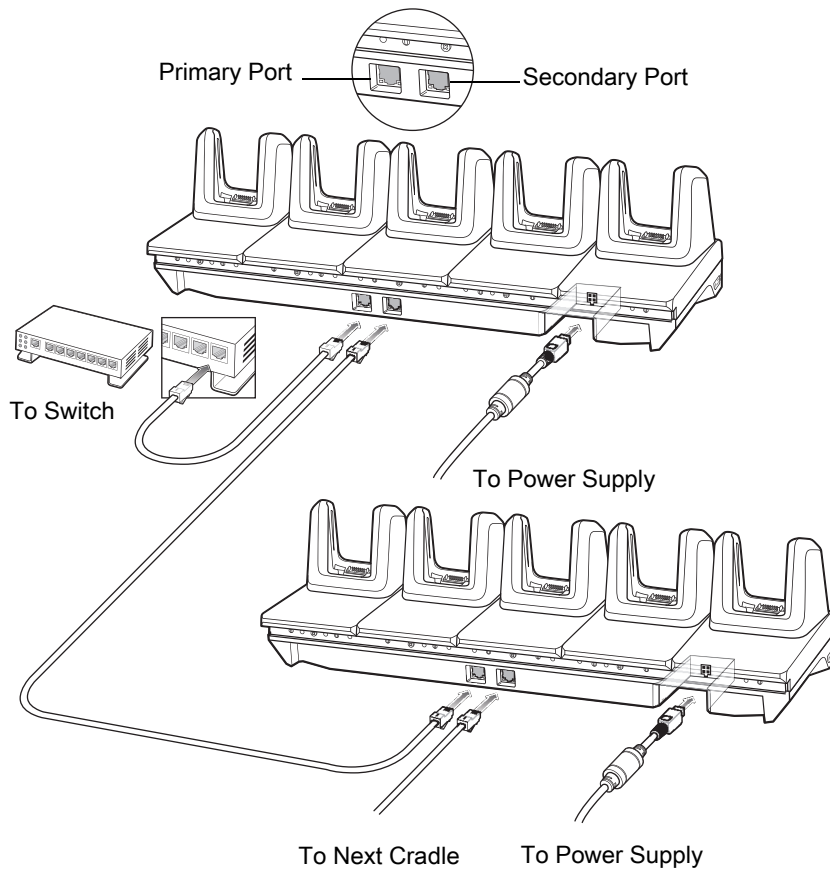

5. Connect additional cradles as described in step 3 and 4.



## Ethernet Settings

The following settings can be configured when using Ethernet communication:

- Proxy Settings
- Static IP.

## Configuring Ethernet Proxy Settings

The MC3300R includes Ethernet cradle drivers. After inserting the MC3300R, configure the Ethernet connection:

1. Swipe down from the status bar to open the quick access panel and then touch .
2. Touch  **Ethernet**.
3. Slide the switch to the **ON** position.
4. Place the MC3300R into the Ethernet cradle slot.
5. Touch and hold **eth0** until the menu appears.
6. Touch **Modify Proxy**.
7. Touch the **Proxy** drop-down list and select **Manual**.



**Figure 9** Ethernet Proxy Settings

eth0

Proxy  
Manual

Proxy hostname  
proxy.example.com

Proxy port  
8080

Bypass proxy for  
example.com,mycomp.test.com,k

CANCEL MODIFY

8. In the **Proxy hostname** field, enter the proxy server address.
9. In the **Proxy port** field, enter the proxy server port number.



**NOTE:** When entering proxy addresses in the Bypass proxy for field, do not use spaces or carriage returns between addresses.

10. In the **Bypass proxy for** text box, enter addresses for web sites that do not require to go through the proxy server. Use the separator “|” between addresses.
11. Touch **MODIFY**.
12. Touch .

## Configuring Ethernet Static IP Address

The MC3300R includes Ethernet cradle drivers. After inserting the MC3300R, configure the Ethernet connection:

1. Swipe down from the status bar to open the quick access panel and then touch .
2. Touch **Ethernet**.
3. Slide the switch to the **ON** position.
4. Place the MC3300R into the Ethernet cradle slot.
5. Touch **eth0**.
6. Touch **Disconnect**.
7. Touch **eth0**.
8. Touch the IP settings drop-down list and select **Static**.

**Figure 10** Static IP Settings

eth0

Proxy  
None

IP settings  
Static

IP address  
192.168.1.128

Gateway  
192.168.1.1

Netmask  
255.255.255.0



DNS 1  
8.8.8.8

DNS 2  
10.61.1.249

CANCEL DISCONNECT

9. In the **IP** address field, enter the proxy server address.
10. If required, in the **Gateway** field, enter a gateway address for the device.
11. If required, in the **Netmask** field, enter the network mask address
12. If required, in the **DNS** address fields, enter a Domain Name System (DNS) addresses.
13. Touch **CONNECT**.
14. Touch .

## Establishing Ethernet Connection

1. Swipe down from the status bar to open the quick access panel and then touch .
2. Touch **Ethernet**.
3. Slide the Ethernet switch to the **ON** position.
4. Insert the device into a slot.  
The  icon appears in the Status bar.
5. Touch **eth0** to view Ethernet connection details.

## LED Indicators

There are two green LEDs on the side of the cradle. These green LEDs light and blink to indicate the data transfer rate.

**Table 7** LED Data Rate Indicators

Data Rate	1000 LED	100/10 LED
1 Gbps	On/Blink	Off
100 Mbps	Off	On/Blink
10 Mbps	Off	On/Blink

## 4-Slot ShareCradle with 4-Slot Battery Charger

The 4-Slot ShareCradle with 4-Slot Battery Charger:

- Provides 9 VDC power for operating the mobile computer and charging the battery.
- Provides 4.2 VDC power for charging spare batteries.
- Simultaneously charges up to four mobile computers and four spare batteries.
- Compatible with the following batteries:
  - MC3300R 5200 mAh PowerPrecision+ extended battery.
  - MC32N0 5200 mAh PowerPrecision extended battery.

**Figure 11** 4-Slot ShareCradle with 4-Slot Battery Charger Setup

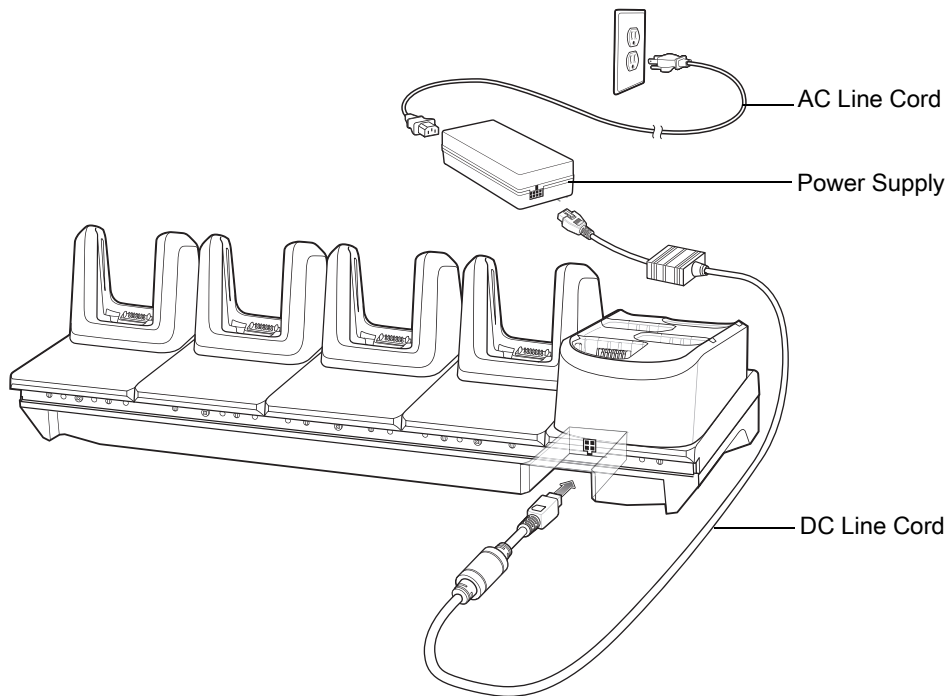

## Charging the MC3300R Battery



**NOTE:** To function properly, remove the lower part of the rubber boot or the entire rubber boot before placing in a charging cradle.

1. Ensure that the cradle is connected to power.
2. Slide the mobile computer into the slot in the cradle. The mobile computer amber Charge LED Indicator, indicates the mobile computer battery charging status.
3. Gently press down on the device to ensure proper contact.
4. When charging is complete, remove the mobile computer from the cradle slot.

## Charging Spare Batteries

Insert the battery into the charger and gently press down on the battery to ensure proper contact.

## Battery Charging in the 4-Slot ShareCradle with 4-Slot Battery Charger

The MC3300R's Charge LED or the spare battery LED indicates the status of the battery charging in the MC3300R. See [Table 9 on page 40](#) for charging status indications.

The MC3300R 5200 mAh PowerPrecision+ extended battery charges from 0% to 90% in less than 3.8 hours at room temperature.

The MC32N0 5200 mAh PowerPrecision extended battery charges from 0% to 90% in less than 5.5 hours at room temperature.

## Charging Temperature

Charge batteries in temperatures from 0 °C to 40 °C (32 °F to 104 °F). Charging is intelligently controlled by the MC3300R.

To accomplish this, for small periods of time, the MC3300R or cradle alternately enables and disables battery charging to keep the battery at acceptable temperatures. The MC3300R or cradle indicates when charging is disabled due to abnormal temperatures via its LED.

## 4-Slot Ethernet ShareCradle with 4-Slot Battery Charger

The 4-Slot Ethernet ShareCradle with 4-Slot Battery Charger:

- Provides 9 VDC power for operating the mobile computer and charging the battery.
- Provides 4.2 VDC power for charging spare batteries.
- Simultaneously charges up to four mobile computers and four spare batteries.
- Compatible with the following batteries:
  - MC3300R 5200 mAh PowerPrecision+ extended battery.
  - MC32N0 5200 mAh PowerPrecision extended battery.

**Figure 12** 4-Slot Ethernet ShareCradle with 4-Slot Battery Charger Setup

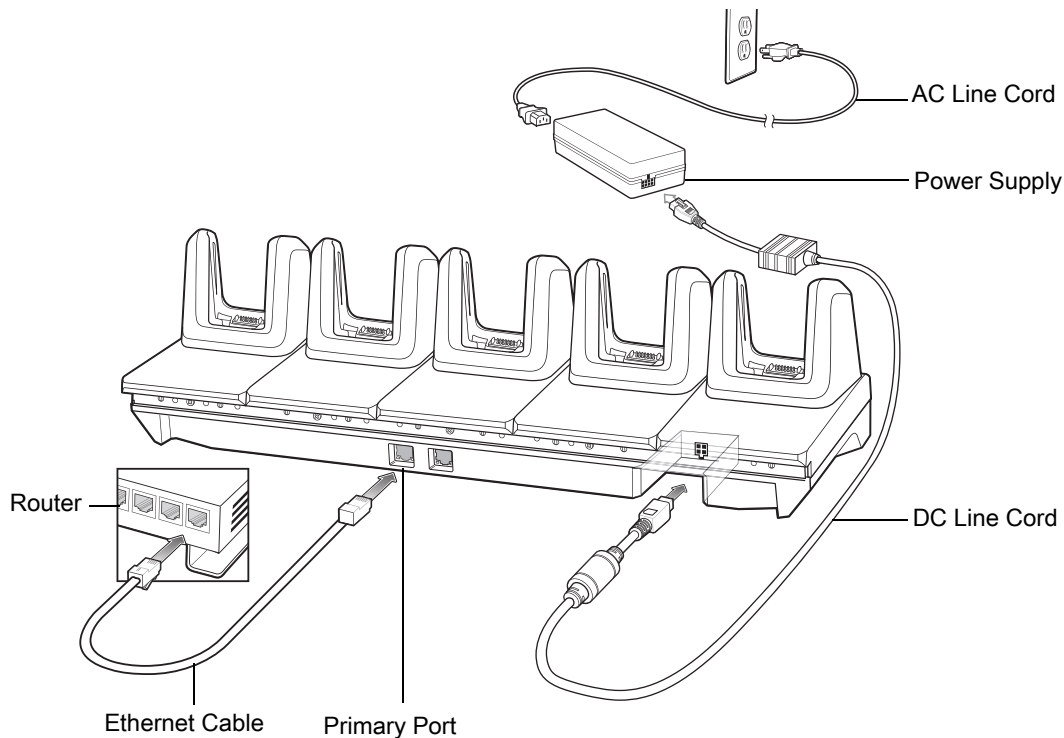

## Charging the MC3300R Battery



**NOTE:** To function properly, remove the lower part of the rubber boot or the entire rubber boot before placing in a charging cradle.

1. Ensure that the cradle is connected to power.
2. Slide the mobile computer into the slot in the cradle. The mobile computer amber Charge LED Indicator, indicates the mobile computer battery charging status.
3. Gently press down on the device to ensure proper contact.
4. When charging is complete, remove the mobile computer from the cradle slot.

## Charging Spare Batteries

Insert the battery into the charger and gently press down on the battery to ensure proper contact.

## Battery Charging in the 4-Slot Ethernet ShareCradle with 4-Slot Battery Charger

The MC3300R's Charge LED or the spare battery LED indicates the status of the battery charging in the MC3300R. See [Table 9 on page 40](#) for charging status indications.

The MC3300R 5200 mAh PowerPrecision+ extended battery charges from 0% to 90% in less than 3.8 hours at room temperature.

The MC32N0 5200 mAh PowerPrecision extended battery charges from 0% to 90% in less than 5.5 hours at room temperature.

### Charging Temperature

Charge batteries in temperatures from 0 °C to 40 °C (32 °F to 104 °F). Charging is intelligently controlled by the MC3300R.

To accomplish this, for small periods of time, the MC3300R or cradle alternately enables and disables battery charging to keep the battery at acceptable temperatures. The MC3300R or cradle indicates when charging is disabled due to abnormal temperatures via its LED.

## Daisy-chaining Ethernet Cradles

Daisy-chain up to ten 5-Slot Ethernet ShareCradle with 4-Slot Battery Chargers to connect several cradles to an Ethernet network. Use either a straight or crossover cable. Daisy-chaining should not be attempted when the main Ethernet connection to the first cradle is 10 Mbps as throughput issues are likely to occur.

To daisy-chain 5-Slot Ethernet ShareCradle with 4-Slot Battery Chargers:

1. Connect power to each 5-Slot Ethernet ShareCradle with 4-Slot Battery Charger.
2. Connect an Ethernet cable to one of the ports on the switch and the other end to the Primary Port of the first cradle.
3. Connect an Ethernet cable to the Secondary port of the first cradle.
4. Connect the other end of the Ethernet cable to the Primary port of the next 5-Slot Ethernet ShareCradle with 4-Slot Battery Charger.

**Figure 13** Daisy-chaining 5-Slot Ethernet ShareCradle with 4-Slot Battery Chargers

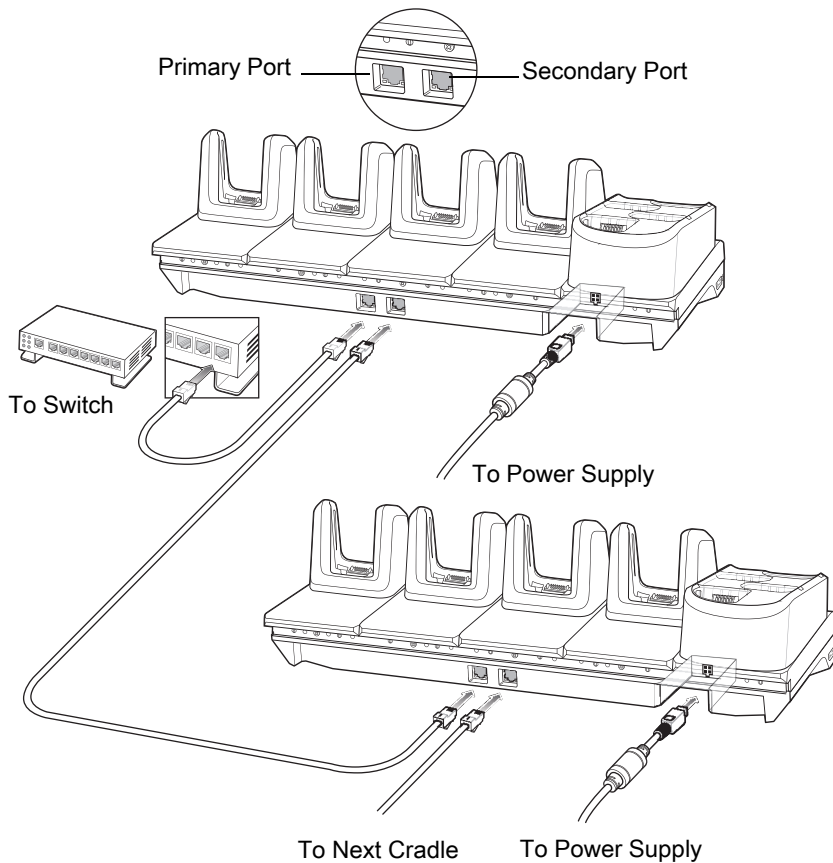

5. Connect additional cradles as described in step 3 and 4.



## Ethernet Settings

The following settings can be configured when using Ethernet communication:

- Proxy Settings
- Static IP.

## Configuring Ethernet Proxy Settings

The MC3300R includes Ethernet cradle drivers. After inserting the MC3300R, configure the Ethernet connection:

1. Swipe down from the status bar to open the quick access panel and then touch .
2. Touch  **Ethernet**.
3. Slide the switch to the **ON** position.
4. Place the MC3300R into the Ethernet cradle slot.
5. Touch and hold **eth0** until the menu appears.
6. Touch **Modify Proxy**.
7. Touch the **Proxy** drop-down list and select **Manual**.



**Figure 14** Ethernet Proxy Settings

eth0

Proxy  
Manual

Proxy hostname  
proxy.example.com

Proxy port  
8080

Bypass proxy for  
example.com,mycomp.test.com,k

CANCEL MODIFY

8. In the **Proxy hostname** field, enter the proxy server address.
9. In the **Proxy port** field, enter the proxy server port number.





**NOTE:** When entering proxy addresses in the Bypass proxy for field, do not use spaces or carriage returns between addresses.

10. In the **Bypass proxy for** text box, enter addresses for web sites that do not require to go through the proxy server. Use the separator “|” between addresses.
11. Touch **MODIFY**.
12. Touch .

## Configuring Ethernet Static IP Address

The MC3300R includes Ethernet cradle drivers. After inserting the MC3300R, configure the Ethernet connection:

1. Swipe down from the status bar to open the quick access panel and then touch .
2. Touch  **Ethernet**.
3. Slide the switch to the **ON** position.
4. Place the MC3300R into the Ethernet cradle slot.
5. Touch **eth0**.
6. Touch **Disconnect**.
7. Touch **eth0**.
8. Touch the IP settings drop-down list and select **Static**.

**Figure 15** Static IP Settings

 **eth0**

Proxy  
**None** ▼

IP settings  
**Static** ▼

IP address  
192.168.1.128

Gateway  
192.168.1.1

Netmask  
255.255.255.0



DNS 1  
8.8.8.8

DNS 2  
**10.61.1.249**

**CANCEL** **DISCONNECT**

9. In the **IP** address field, enter the proxy server address.
10. If required, in the **Gateway** field, enter a gateway address for the device.
11. If required, in the **Netmask** field, enter the network mask address
12. If required, in the **DNS** address fields, enter a Domain Name System (DNS) addresses.
13. Touch **CONNECT**.
14. Touch  .

## Establishing Ethernet Connection

1. Swipe down from the status bar to open the quick access panel and then touch .
2. Touch **Ethernet**.
3. Slide the Ethernet switch to the **ON** position.
4. Insert the device into a slot.  
The  icon appears in the Status bar.
5. Touch **eth0** to view Ethernet connection details.

## LED Indicators

There are two green LEDs on the side of the cradle. These green LEDs light and blink to indicate the data transfer rate.

**Table 8** LED Data Rate Indicators

Data Rate	1000 LED	100/10 LED
1 Gbps	On/Blink	Off
100 Mbps	Off	On/Blink
10 Mbps	Off	On/Blink

---

## 4-Slot Spare Battery Charger

The 4-Slot Battery Charger:

- Charges up to four MC3300R spare batteries.
- Provides 4.2 VDC power to charge the spare battery.
- Compatible with the following batteries:
  - MC3300R 5200 mAh PowerPrecision+ extended battery.
  - MC32N0 5200 mAh PowerPrecision extended battery.

### Charging Spare Batteries

1. Connect the charger to a power source.
2. Insert the battery into the charger and gently press down on the battery to ensure proper contact.

**Figure 16** 4-Slot Battery Charger Setup

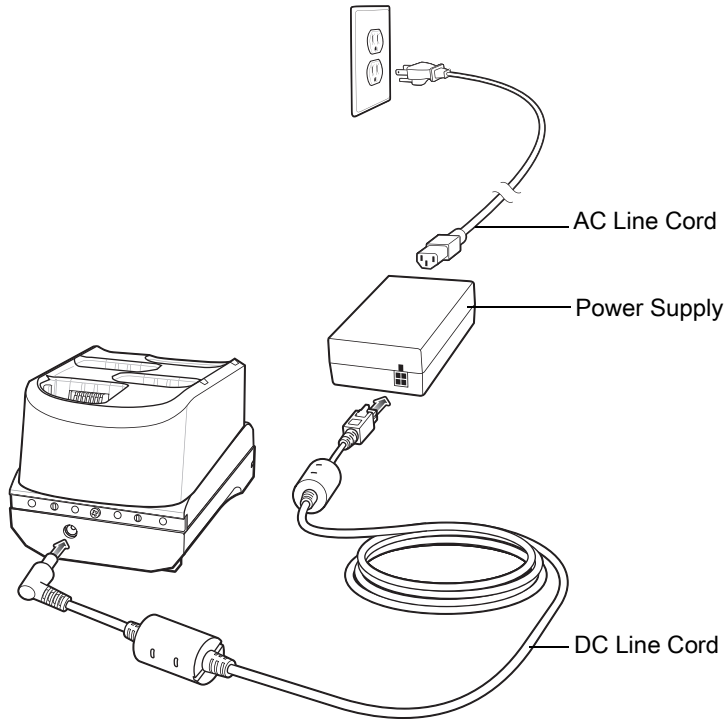

## Battery Charging

### Spare Battery Charging

Each Battery Charging LED indicates the status of the battery charging in each slot. The table below describes the Battery Charging LED status.

**Table 9** Battery LED Charging Indicators

LED	Indication
Off	<ul style="list-style-type: none"> <li>The battery is not charging.</li> <li>The battery is not inserted correctly in the cradle or connected to a power source.</li> <li>Cradle is not powered.</li> </ul>
Solid Amber	<ul style="list-style-type: none"> <li>Battery is charging.</li> </ul>
Solid Green	<ul style="list-style-type: none"> <li>Battery charging is complete.</li> </ul>
Fast Blinking Red 2 blinks/second	Charging error, e.g.: <ul style="list-style-type: none"> <li>Temperature is too low or too high.</li> <li>Charging has gone on too long without completion (typically eight hours).</li> </ul>
Solid Red	<ul style="list-style-type: none"> <li>Spare battery is charging and battery is at the end of useful life.</li> <li>Charging complete and battery is at the end of useful life.</li> </ul>

The MC3300R 5200 mAh PowerPrecision+ extended battery charges from 0% to 90% in less than 3.8 hours at room temperature.

The MC32N0 5200 mAh PowerPrecision extended battery charges from 0% to 90% in less than 5.5 hours at room temperature.

### Charging Temperature

Charge batteries in temperatures from 0 °C to 40 °C (32 °F to 104 °F). Charging is intelligently controlled by the MC3300R.

To accomplish this, for small periods of time, the charger alternately enables and disables battery charging to keep the battery at acceptable temperatures. The charger indicates when charging is disabled due to abnormal temperatures via its LED.

---

## 20-Slot Spare Battery Charger

The 20-Slot Battery Charger:

- Charges up to twenty MC3300R spare batteries.
- Provides 4.2 VDC power to charge the spare battery.
- Compatible with the following batteries:
  - MC3300R 5200 mAh PowerPrecision+ extended battery.
  - MC32N0 5200 mAh PowerPrecision extended battery.

### Charging Spare Batteries

1. Connect the charger to a power source.
2. Insert the battery into the charger and gently press down on the battery to ensure proper contact.

**Figure 17** 20-Slot Battery Charger Setup

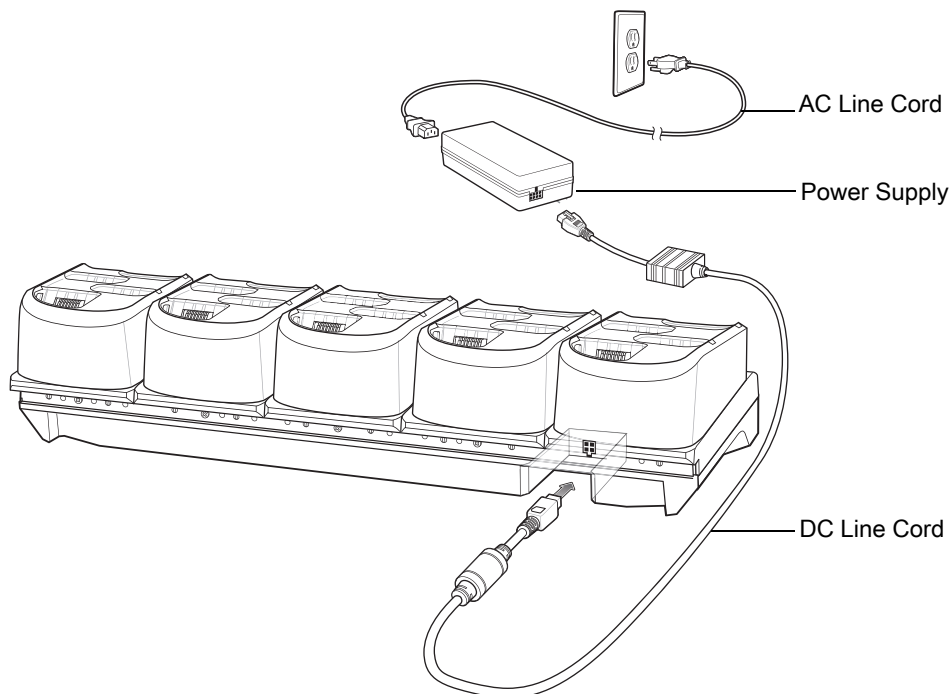

## Battery Charging

### Spare Battery Charging

Each Battery Charging LED indicates the status of the battery charging in each slot. The table below describes the Battery Charging LED status.

**Table 10** 20-Slot Battery LED Charging Indicators

LED	Indication
Off	<ul style="list-style-type: none"> <li>The battery is not charging.</li> <li>The battery is not inserted correctly in the cradle or connected to a power source.</li> <li>Cradle is not powered.</li> </ul>
Solid Amber	<ul style="list-style-type: none"> <li>Battery is charging.</li> </ul>
Solid Green	<ul style="list-style-type: none"> <li>Battery charging is complete.</li> </ul>
Fast Blinking Red 2 blinks/second	Charging error, e.g.: <ul style="list-style-type: none"> <li>Temperature is too low or too high.</li> <li>Charging has gone on too long without completion (typically eight hours).</li> </ul>
Solid Red	<ul style="list-style-type: none"> <li>Spare battery is charging and battery is at the end of useful life.</li> <li>Charging complete and battery is at the end of useful life.</li> </ul>

The MC3300R 5200 mAh PowerPrecision+ extended battery charges from 0% to 90% in less than 5.5 hours at room temperature.

The MC32N0 5200 mAh PowerPrecision extended battery charges from 0% to 90% in less than 5.5 hours at room temperature.

### Charging Temperature

Charge batteries in temperatures from 0 °C to 40 °C (32 °F to 104 °F). Charging is intelligently controlled by the MC3300R.

To accomplish this, for small periods of time, the charger alternately enables and disables battery charging to keep the battery at acceptable temperatures. The charger indicates when charging is disabled due to abnormal temperatures via its LED.

## USB Charge Cable

The USB Charge Cable:

- Provides 5 VDC power to charge the battery.
- Provides power and/or communication with the host computer over USB to the device.
- Compatible with devices using the following batteries:
  - MC3300R 5200 mAh PowerPrecision+ extended battery.
  - MC32N0 5200 mAh PowerPrecision extended battery.

The USB Charge Cable snaps onto the bottom of the MC3300R and removes easily when not in use. When attached to the MC3300R allows charging only.

**Figure 18** USB Charge Cable

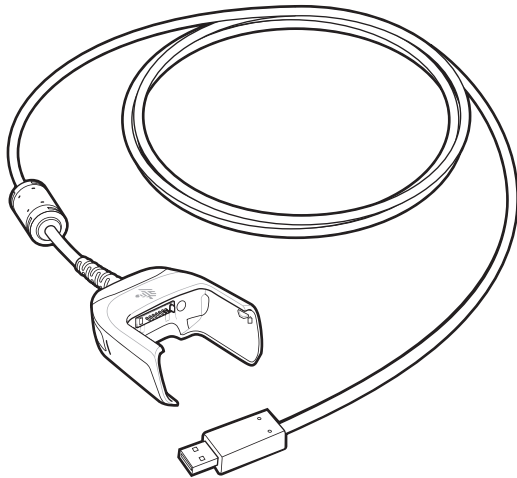

## Connecting the USB Charge Cable to Device



**NOTE:** To function properly, remove the lower part of the rubber boot or the entire rubber boot before placing in a charging cradle.

To connect the USB Charge Cable to the device, insert the USB Charge Cable straight onto the device until the device touches the bottom of the cable cup.

**Figure 19** Connecting the USB Charge Cable

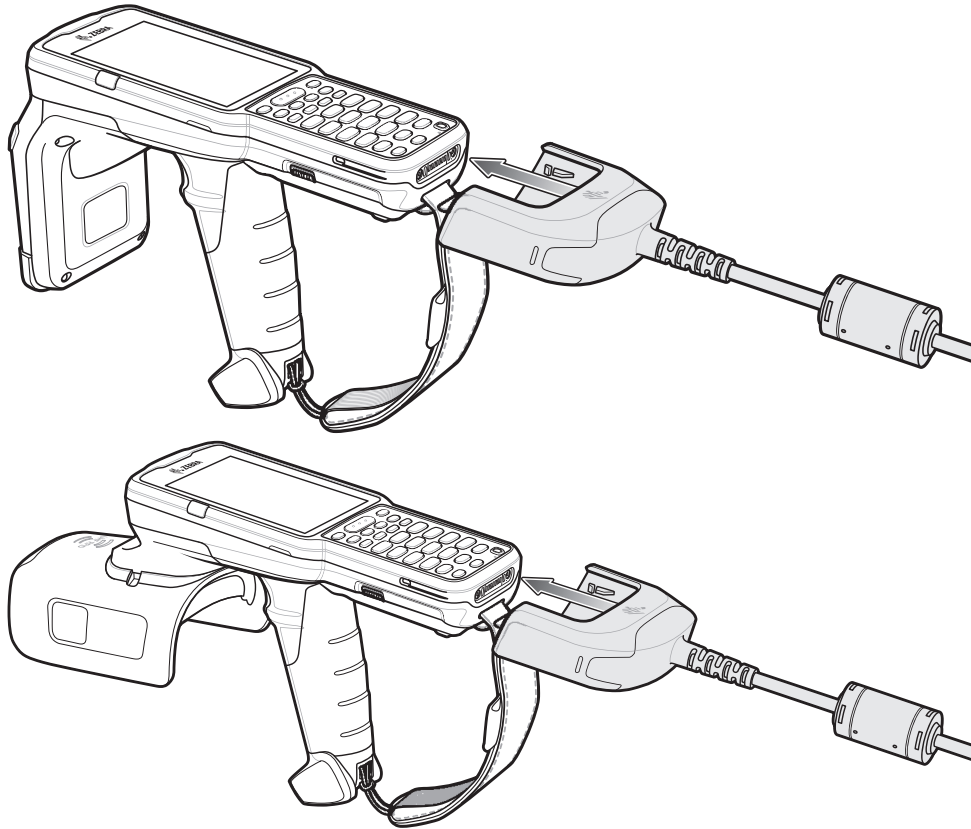

### Connecting the USB Charge Cable to Host Computer

To connect the USB Charge Cable to a host computer:

1. Connect the USB Charge Cable to the MC3300R.
2. Connect the USB connector of the cable to a host computer.

**Figure 20** Connecting USB Charge Cable to Host Computer

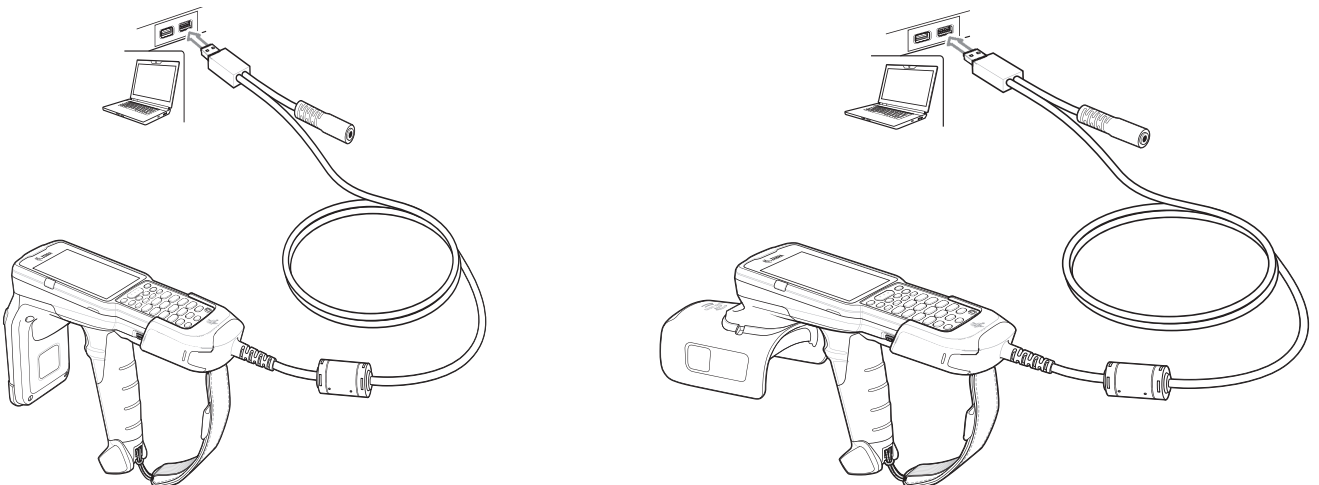



## Main Battery Charging

The device's Charging/Notification LED indicates the status of the battery charging in the device.



**NOTE:** Charging using a host computer USB port could take longer.

To achieve the best charging results use only Zebra charging accessories and batteries. Charge batteries at room temperature with the in sleep mode.

## Charging the Device

To charge the device using the USB Charge Cable:

1. Connect the USB Charge Cable to the MC3300R.
2. Connect the USB connector of the power supply.
3. Plug the power supply into a power outlet.

**Figure 21** Charging the Device

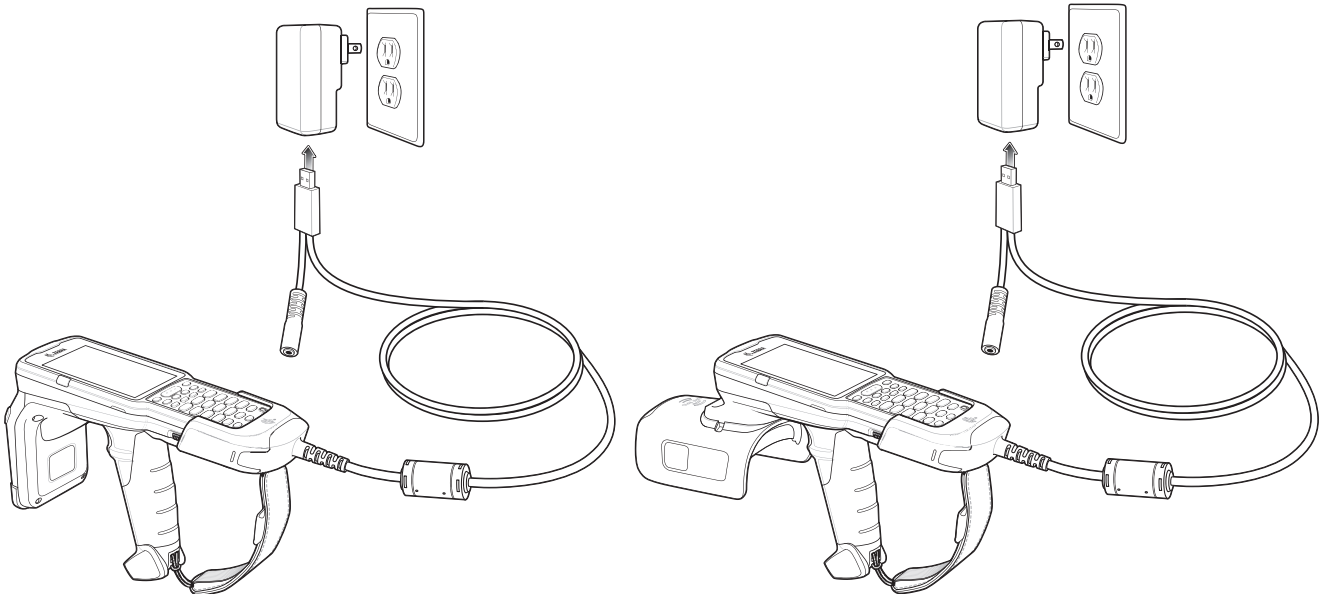

## Main Battery Charging

The device's Charging/Notification LED indicates the status of the battery charging in the device.



**NOTE:** In many cases the 90% charge provides plenty of charge for daily use.

To achieve the best charging results use only Zebra charging accessories and batteries. Charge batteries at room temperature with the MC3300R in sleep mode.

The MC3300R 5200 mAh PowerPrecision+ extended battery charges from 0% to 90% in less than 6 hours at room temperature.

The MC32N0 5200 mAh PowerPrecision extended battery charges from 0% to 90% in less than 6 hours at room temperature.

## Disconnecting the USB Charge Cable

To disconnect the USB Charge Cable from the MC3300R:

1. Grasp the cable cup in one hand (by pinching the front and back) and the device in the other hand.
2. Remove the device by pulling straight up.

**Figure 22** Disconnecting the USB Charge Cable

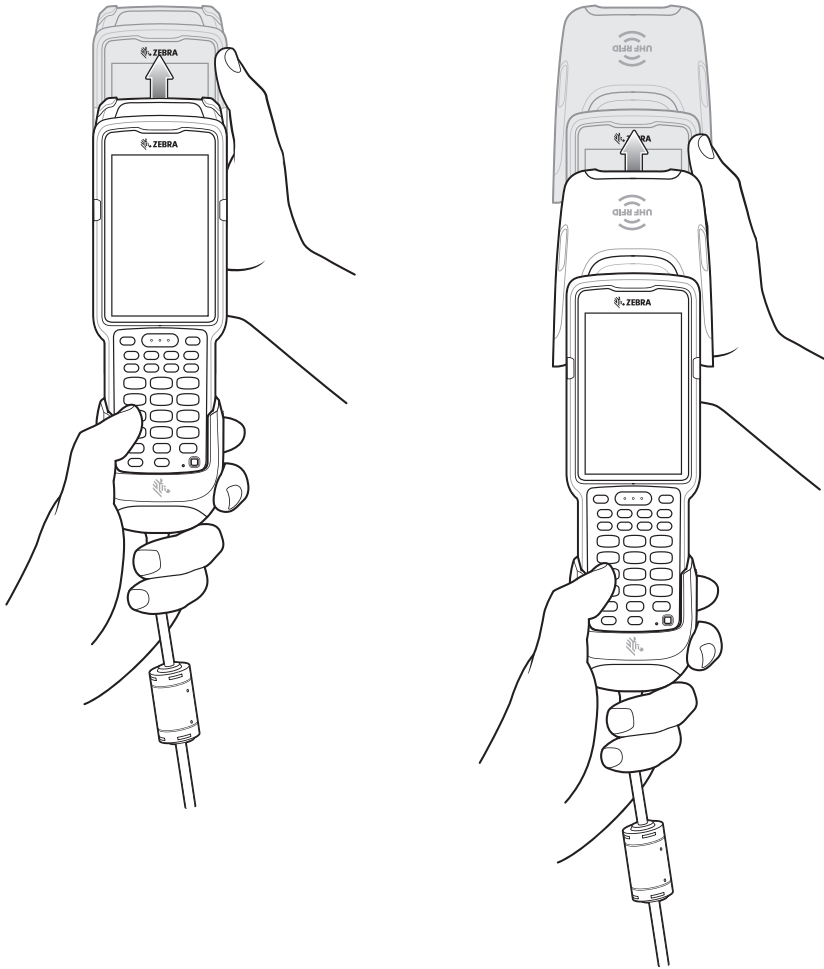

## MC33XX Charge Only Adapter

Use the MC33XX Charge Only Adapter for backwards compatibility with the MC32N0 cradles and the MC3300R mobile computer.

- MC33XX Charge Only Adapter supports the MC32N0 1-Slot USB Cradle, MC32N0 4-Slot Charge Only Cradle, and MC32N0 4-Slot Ethernet Cradle.
- MC33XX Charge Only Adapter provides charge only; no communication when used with the MC32N0 cradles.
- MC32N0 1-Slot USB Cradle provides 5.4V DC to charge the device.
- MC32N0 1-Slot USB Cradle (with the MC33XX Charge Only Adapter) is compatible with an MC3300R mobile computer charging either an MC3300R PowerPrecision+ extended battery or an MC32N0 PowerPrecision extended battery, but the MC32N0 1-Slot USB Cradle spare battery slot is only compatible with the MC32N0 PowerPrecision batteries.

### Adapter Installation

To install the MC33XX Charge Only Adapter into the MC32N0 Cradle:

1. Clean the MC32N0 cradle and contacts with an alcohol wipe, using a back and forth motion with your finger. For more information about cleaning, see [Troubleshooting](#).

**Figure 23** Clean MC32N0 Cradle

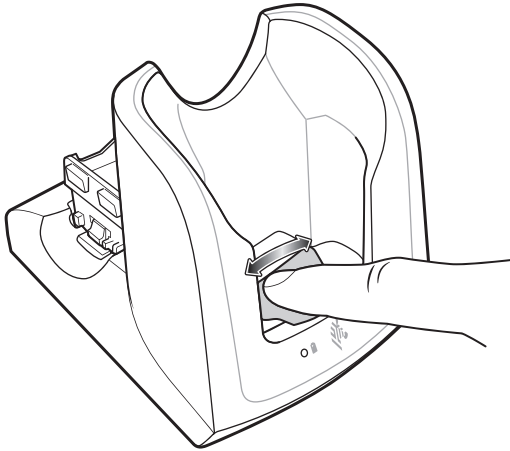

2. Peel and remove the adhesive from the back of the adapter.

**Figure 24** Peel and Remove Adhesive

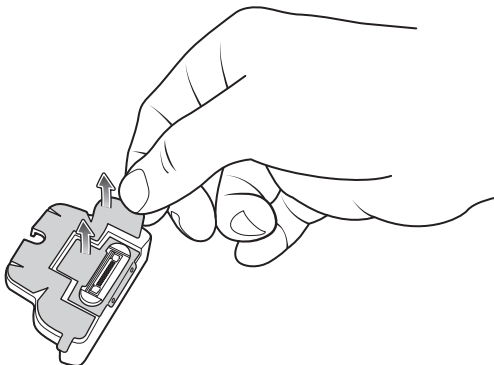

3. Insert the adapter into the MC32N0 cradle and adhere to the bottom of the cradle.

**Figure 25** Insert Adapter into Cradle and Adhere

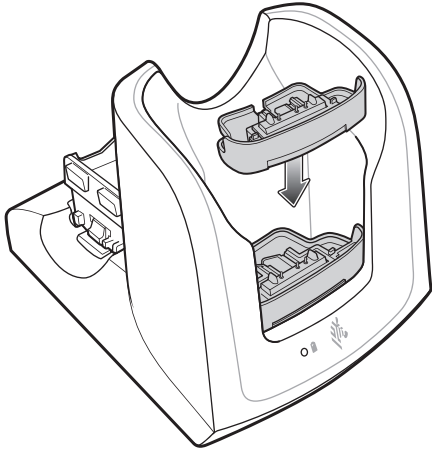

4. Insert the MC3300R device into the MC32N0 cradle.

**Figure 26** Insert MC3300R device into MC32N0 Cradle

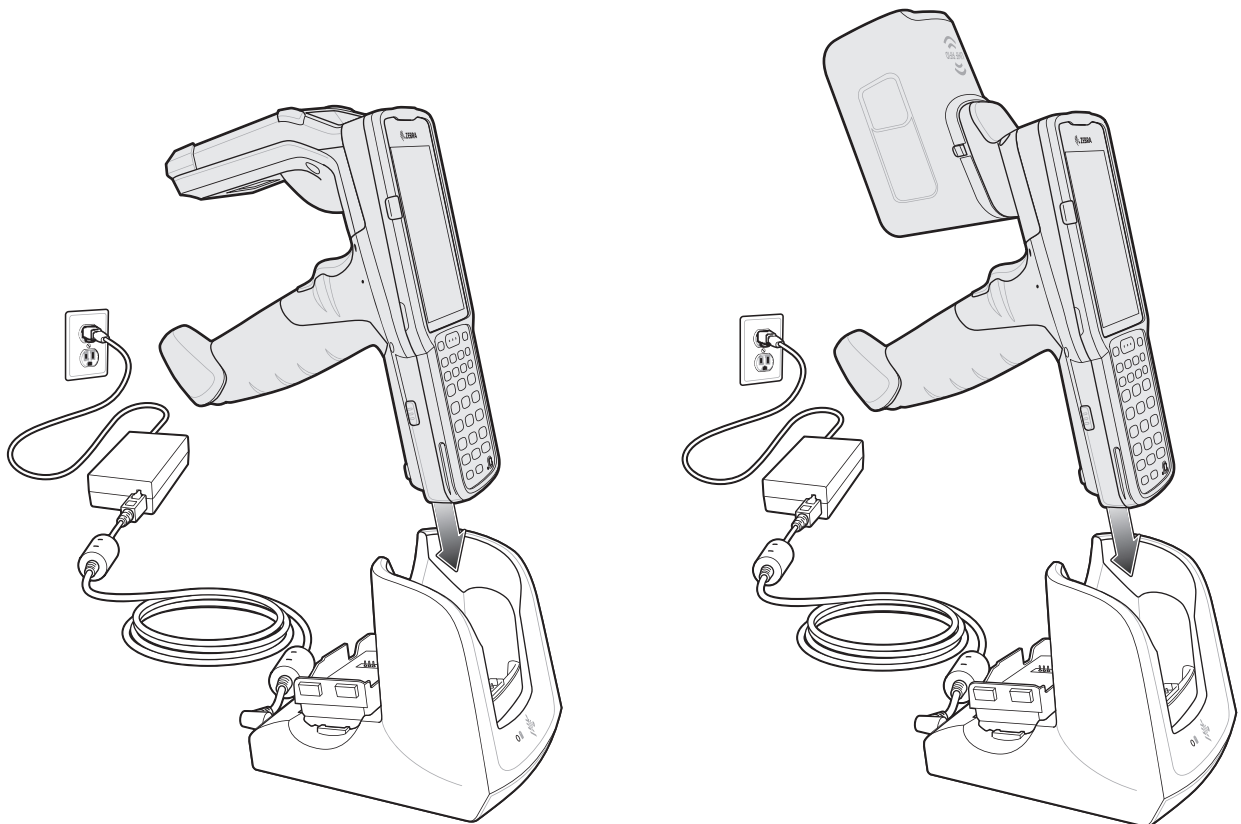

The MC3300R 5200 mAh PowerPrecision+ extended battery charges from 0% to 90% in less than 5.5 hours at room temperature.

The MC32N0 5200 mAh PowerPrecision extended battery charges from 0% to 90% in less than 5.5 hours at room temperature.

### **Charging Temperature**

Charge batteries in temperatures from 0 °C to 40 °C (32 °F to 104 °F). Charging is intelligently controlled by the MC3300R.

To accomplish this, for small periods of time, the MC3300R or cradle alternately enables and disables battery charging to keep the battery at acceptable temperatures. The MC3300R or cradle indicates when charging is disabled due to abnormal temperatures via its LED.

## MC3300R Rubber Boot

The rubber boot provides additional protection for the MC3300R.



**NOTE:** To function properly, remove the lower part of the rubber boot or the entire rubber boot before placing in a charging cradle.

If the hand strap is attached, release the hand strap to install the rubber boot. After the rubber boot is installed, reattach the hand strap.

To attach the rubber boot:

1. If the hand strap is attached, remove the hand strap.
2. Slide the battery end of the MC3300R into the bottom of the rubber boot.

**Figure 27** Slide MC3300R into Bottom of Rubber Boot

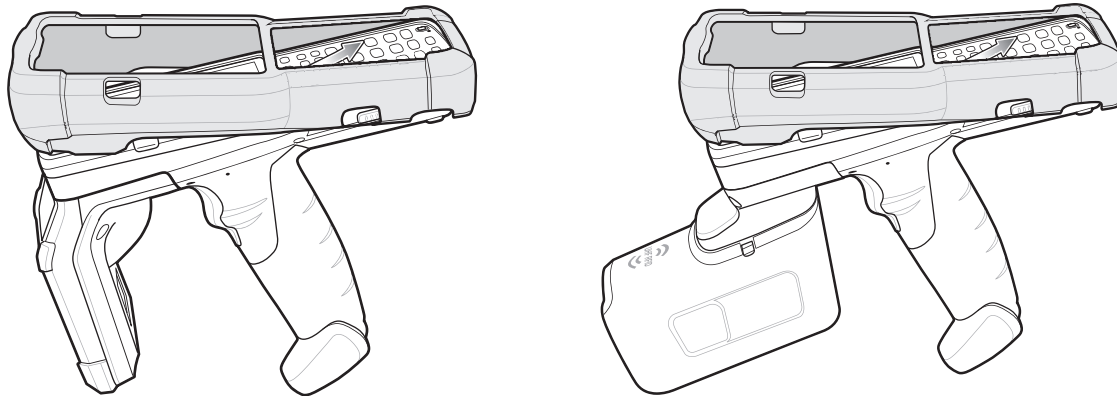

3. Grasp the top of the rubber boot and place over the top of the MC3300R.
4. Re-attach the hand strap (see [Hand Strap on page 55](#)).

**Figure 28** Place Rubber Boot Over Top of MC3300R

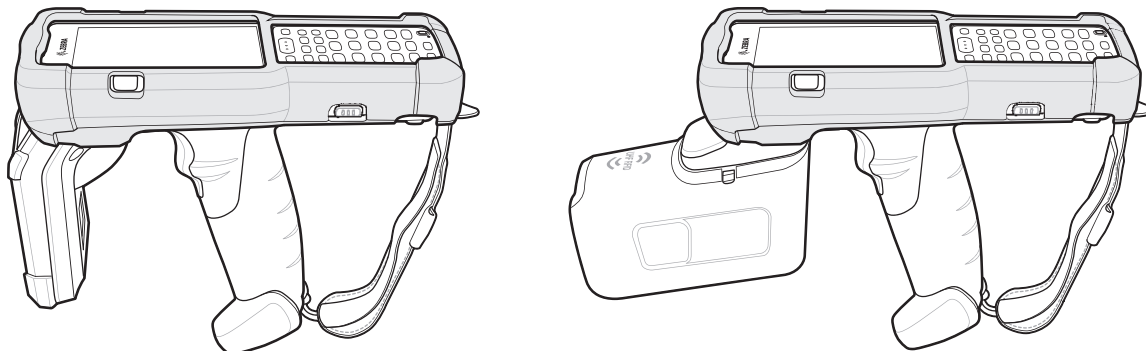

---

## Fabric Holster

The Fabric Holster provides a soft holder for the mobile computer. It consists of a fabric mobile computer holder, a detachable shoulder strap and a belt strap. See figures below to attach the Fabric Holster to a belt and shoulder strap.

### Belt Strap

Attach the Fabric Holster to a belt or waist band.

**Figure 29** Attach the Fabric Holster to a Belt

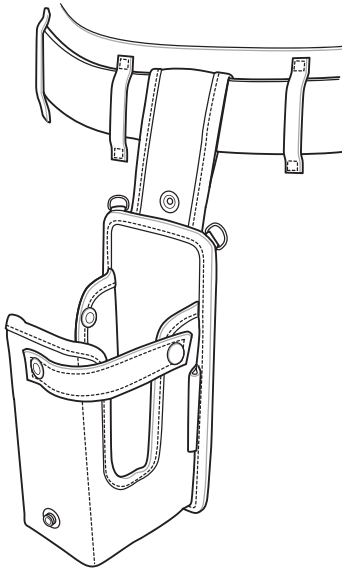

### Shoulder Strap

Attach the fabric holster to a shoulder strap.

**Figure 30** Attach Fabric Holster and Shoulder Strap

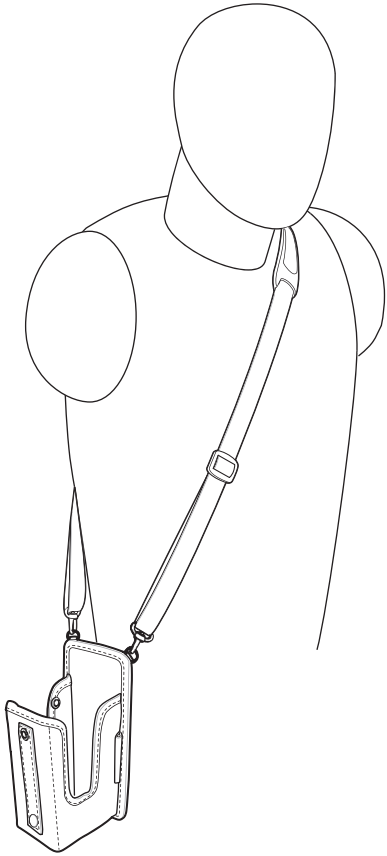

## Using the Belt Strap

The Fabric Holster holds the MC3300R on a belt or waist band.

1. Secure the Belt Strap over the belt or waistband and snap into place.

**Figure 31** Secure Belt Strap On Belt

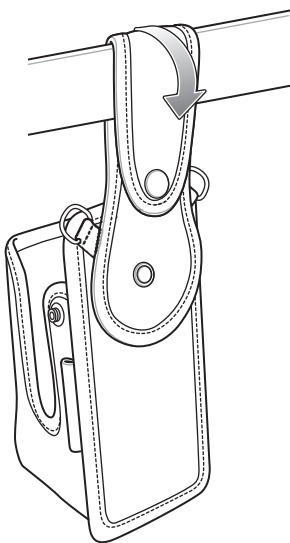



2. To insert the MC3300R, slide the mobile computer (battery end first) into the Fabric Holster with the screen facing the user.

**Figure 32** Insert MC3300R

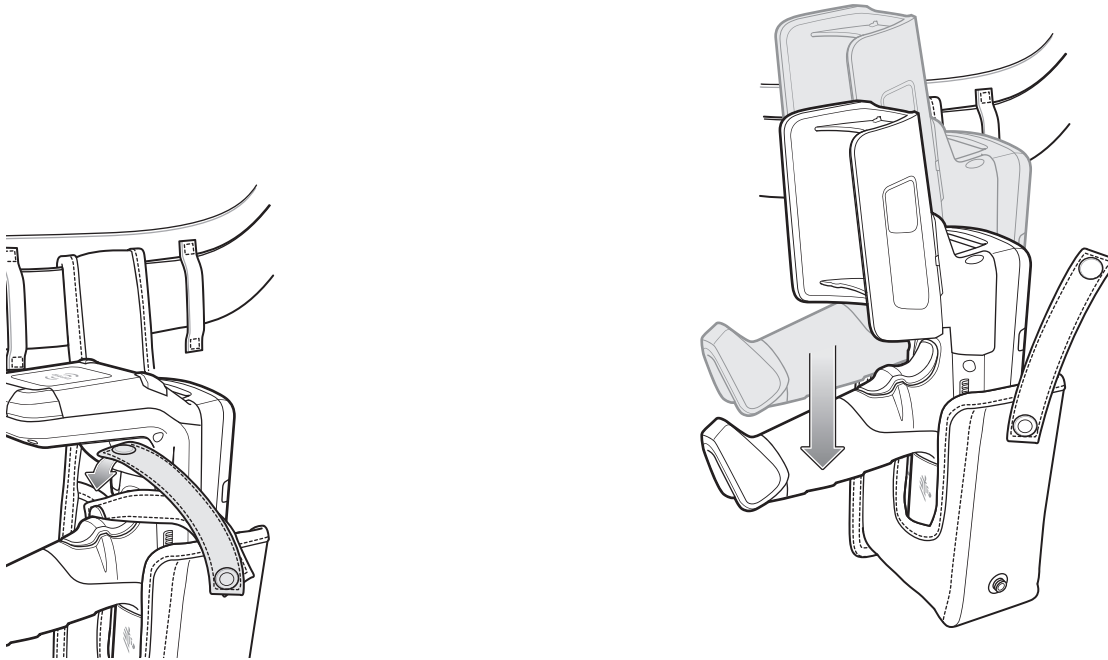

3. Secure the MC3300R with the restraining strap and place over the MC3300R to secure in place.

**Figure 33** Secure with Strap

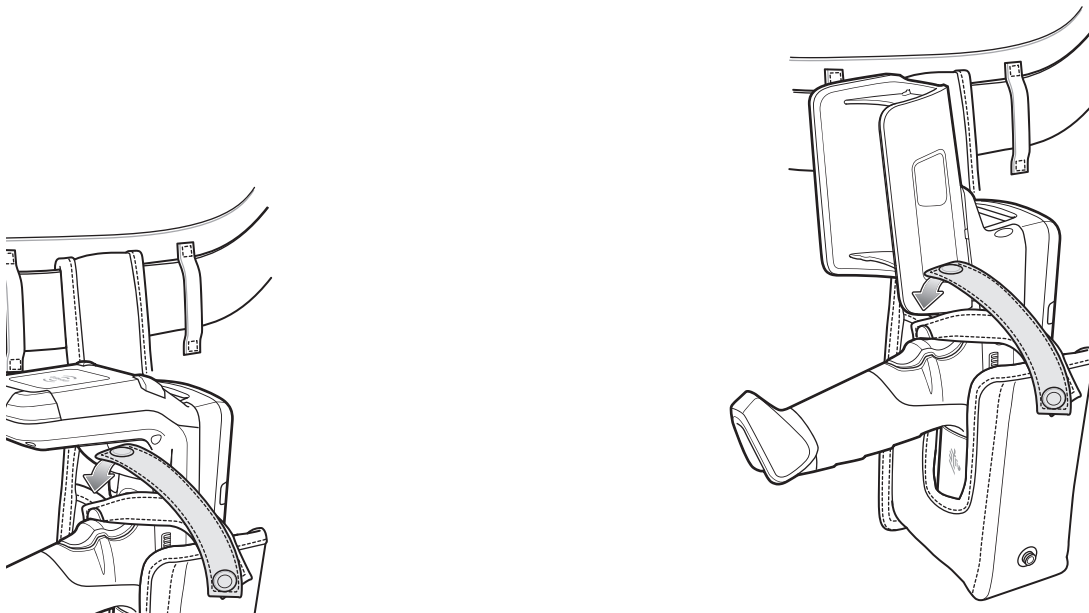

4. To remove the MC3300R, unsnap the restraining strap to release. Lift the MC3300R out of Fabric Holster.

### Using the Shoulder Strap

1. Connect the clips on the shoulder strap to the rings on the fabric holster.
2. Place the shoulder strap over your head and rest on your shoulder.

**Figure 34** Shoulder Strap

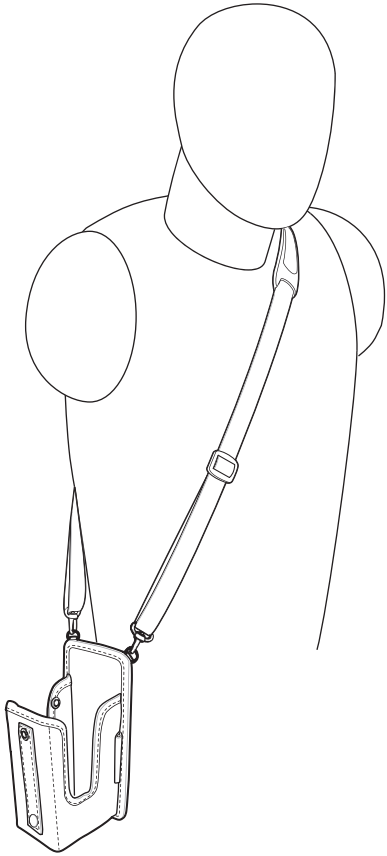

3. Lift the strap and insert the MC3300R into the holster.
4. Secure the strap to hold the MC3300R in place.

## Hand Strap

To install the hand strap:

1. Thread the lanyard loop through the opening near the base of the trigger handle.

**Figure 35** Insert Loop Through Handle Slot

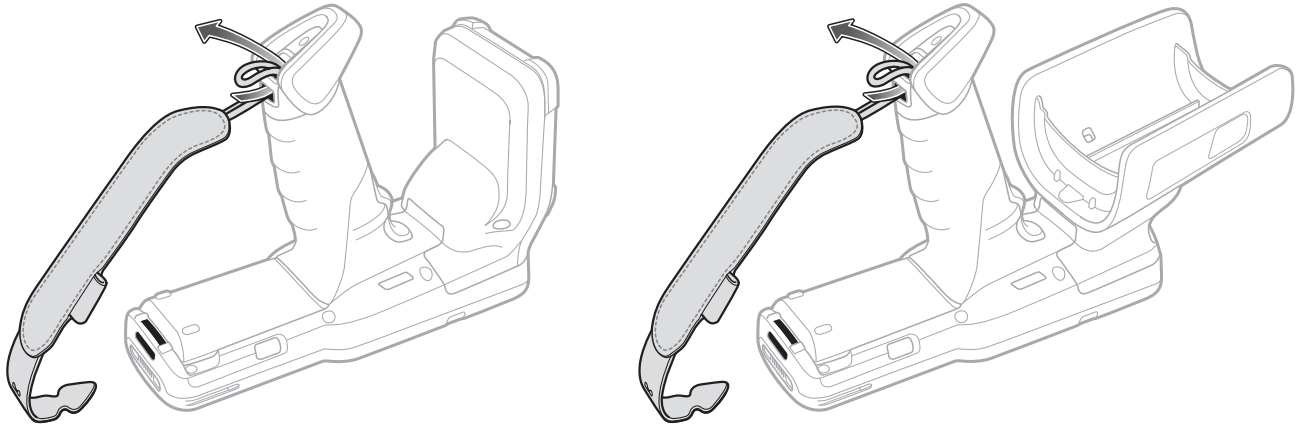

2. Insert the top end of the hand strap through the loop.

**Figure 36** Thread Hand Strap Through Loop

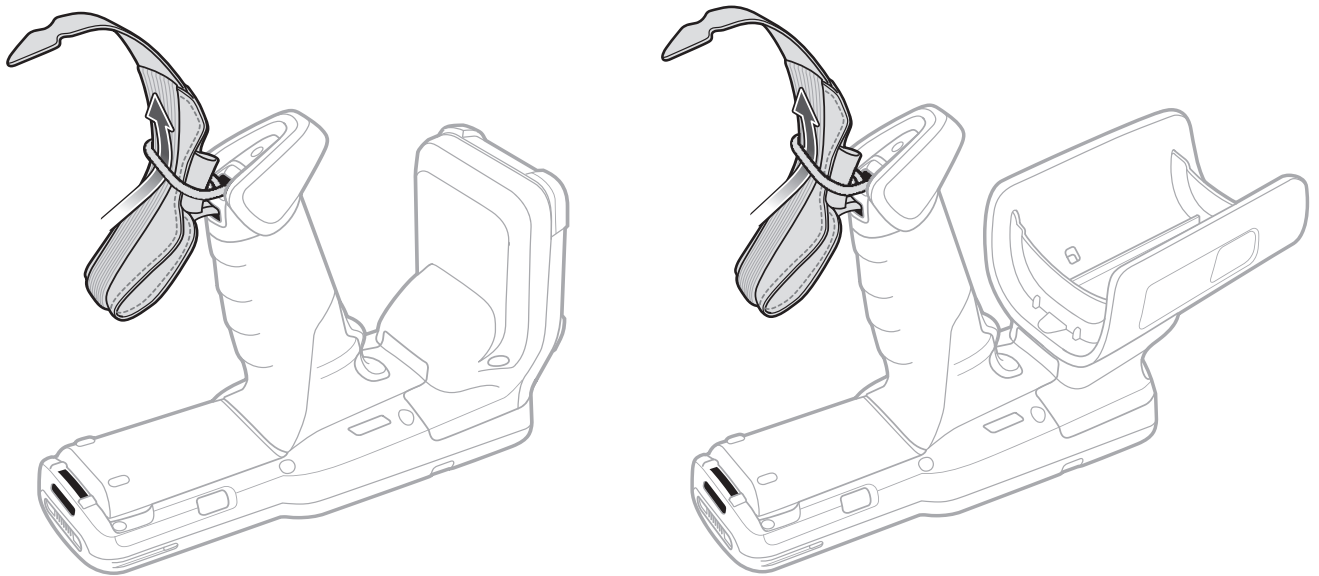

3. Thread the hand strap through the lanyard.
4. Pull the hand strap through the loop.
5. Thread the end of the hand strap with the tab through the slot on the bottom of the MC3300R.

**Figure 37** Thread Tab Through Slot

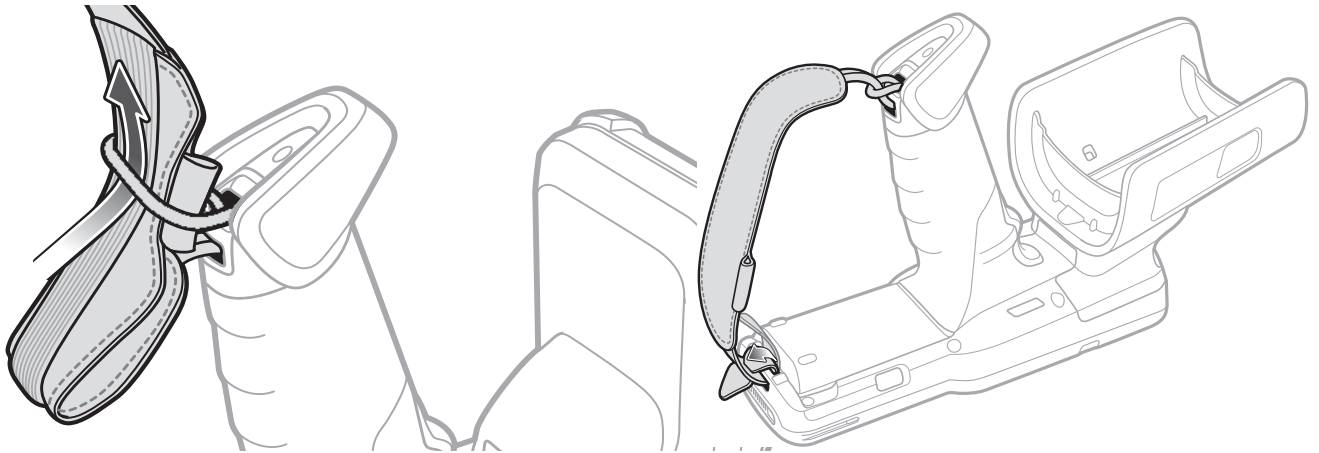

6. Slide the tab through the slit in the hand strap so that the tip of the tab is facing away from the MC3300R.

# Zebra RFID Mobile Application for Android

The upgraded Zebra RFID Mobile Application is now called the 123RFID Mobile Application. For detailed information about this app refer to the 123RFID Mobile Application User Guide, p/n MN-003765-xx. This guide describes the app for Android and demonstrates the device's capability and tag operation functionality.

The guide is available at: [zebra.com/support](https://zebra.com/support).

# RFID Manager

---

## Introduction

The Zebra RFID Manager application allows the user to perform various management functions on the RFID reader module in the MC3300R device including firmware update, power control for the RFID Radio, resetting the RFID module to factory defaults, and various other functions.



**NOTE:** Some screens shown in this guide may differ from the actual screens shown on the device. Screens are subject to change with future releases.

---

## Using the RFID Manager for Android

To use this application for RFID operations:

1. Launch the RFID Manager application for Android on the mobile device.
2. During initial use, set the region in which the device is operating. To set the region, open the application and select **Settings > Regulatory**.



**NOTE:** If the RFID Demo application or partner application is connected to the MC3300R, the RFID Manager can still perform all management functions, however care should be used as to not interfere with any ongoing operational behavior of the device (e.g., inventory, setting parameters, etc.).

## Connection Status

### Reader Status

By default, the RFID Reader is powered on and in the **Ready**. If the MC3300R RFID Radio is not powered on, the Reader Status displays **Off**.

Figure 38 Reader Connection Status Screens

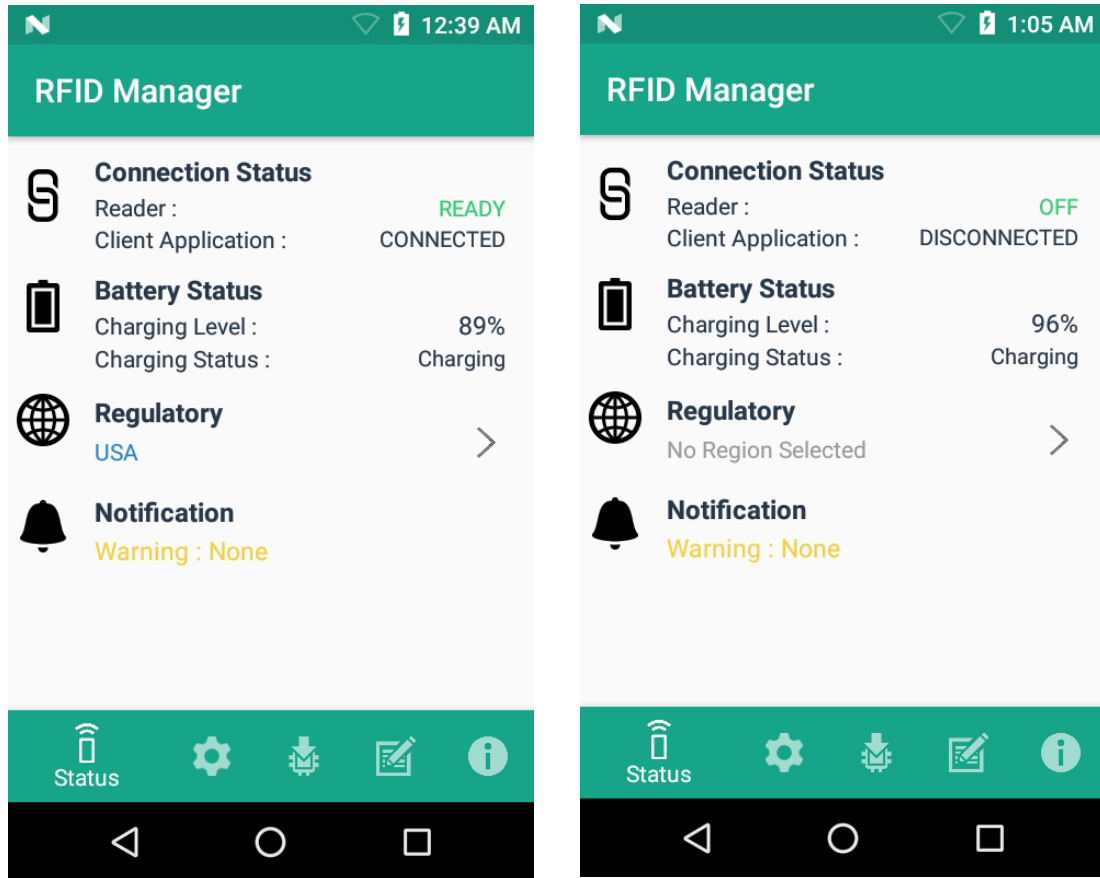

## Client Application Status

If the MC3300R RFID Reader Status is **Ready**:

1. Launch the application manually.
2. On the **Home** Screen under **Connection Status > Client Application**, it indicates if the client application is **Connected** or **Disconnected** to the MC3300R RFID Reader.

**Figure 39** Client Application Status Screens

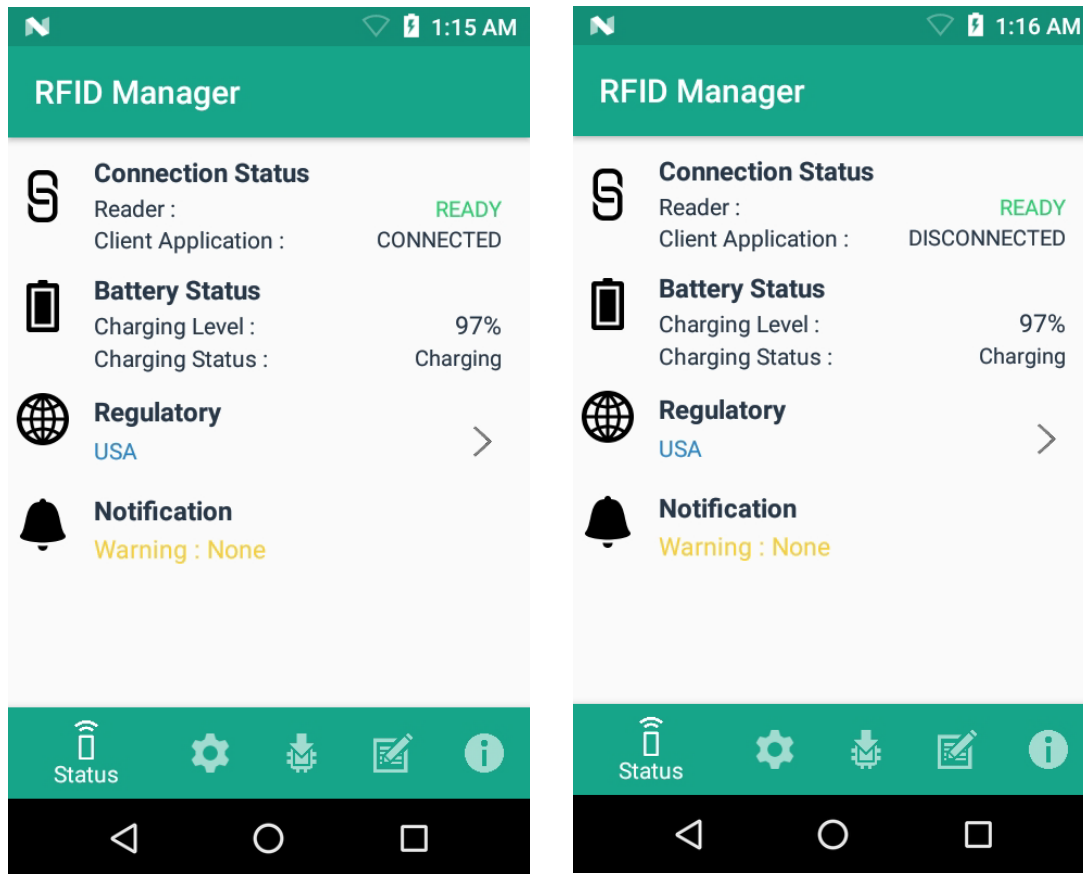

The **Battery Status** contains the battery **Charging Level** percentage and the **Charging Status** (Charging or Discharging).



## RFID Regulatory

To set the region, select the **Regulatory** arrow button to open the **Regulatory** screen. Select the **Region** and **Channel Selection** settings and tap the **Apply** button. The **Region** drop-down displays the current region to which the device is set. Choose the correct region before using the device.



**NOTE:** The **Region** and **Channel Selection** requires setup before the initial use only. However, if a **Reset to Factory Defaults** operation is conducted on the MC3300R RFID Reader, the operation removes the **Region** and **Channel** and needs to be set again.



**NOTE:** Select only the country in which you are using the device.

- **Channel Selection** is allowed only for the regions that allow channel setting.
- Supported regions are those reported by the specific MC3300R Model.
- If the region is not configured on the MC3300R, the Regulatory status shows as NA.
- A customer application can also set the region and configuration programmatically.

**Figure 40** Regulatory Screens

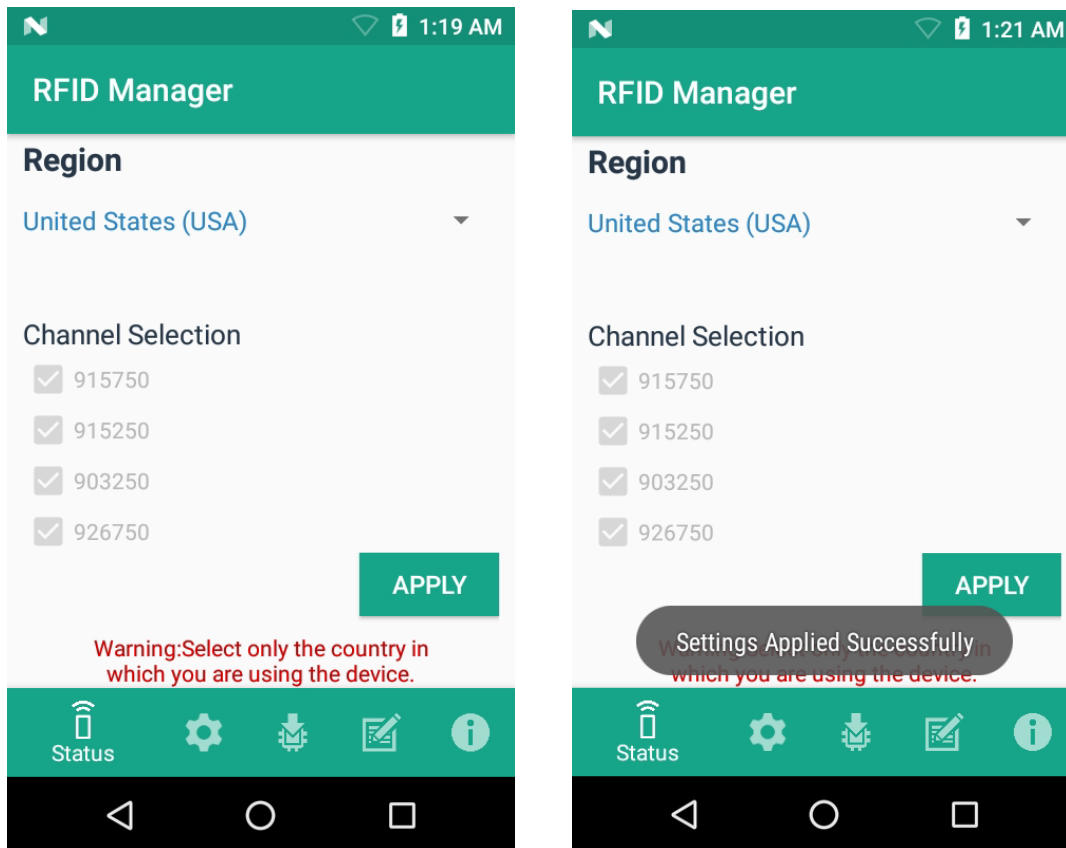

## Settings

To display Settings, select the **Settings** icon located on the bottom tool bar.

Turn on the **Settings** slider switch control to enable control of setting options.

Setting options are as follows:

- **Temperature Notification** – If enabled, a temperature high and critical notification appears with temperature level indications.
- **Reader Power Off/On** - If enabled, the MC3300R RFID Radio is powered on. When the MC3300R RFID radio is powered off, no RFID operations are supported.

**Figure 41** Settings Screen

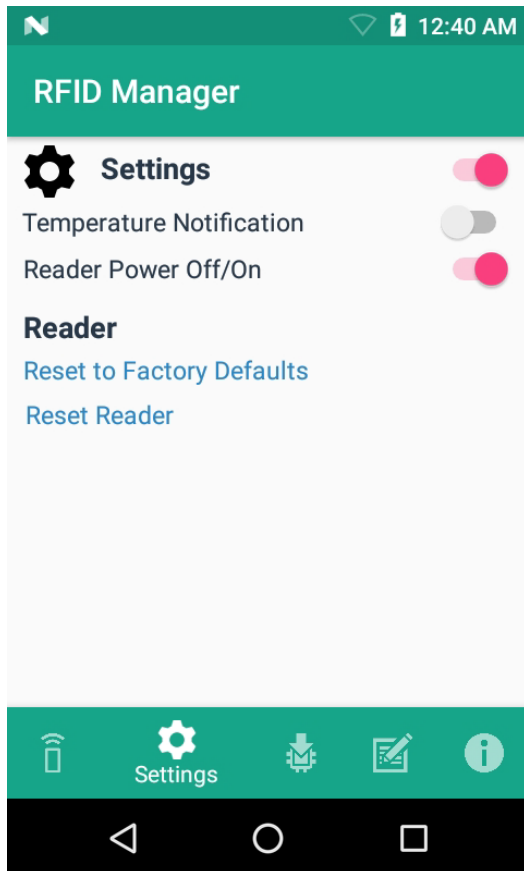

- **Reset to Factory Defaults** - Select **Reset to Factory Defaults** to reset all configuration and region settings to factory default settings. When selected, the RFID reader internally reboots and a window message displays after successful operation.

**Figure 42** Reset to Factory Defaults Screen

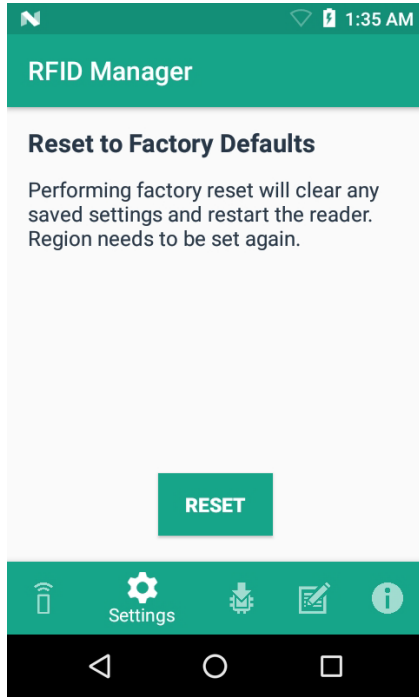

- **Reset Reader** - Select **Reset Reader** to perform a reader restart. When selected, the reader reboots and a window message displays after successful operation. Reader status confirmation is located under **Home > Status**.

**Figure 43** Reader Reset Screen

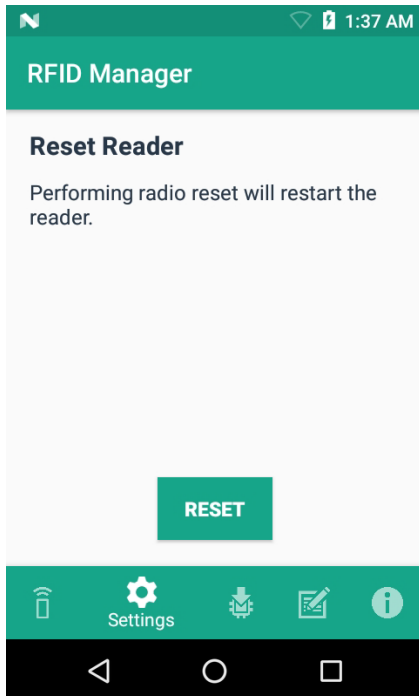

## Firmware Update

A product code update, bootloader, and radio update may be performed using the firmware update screen.



**NOTE:** More than 15% battery level is required to perform a Firmware Update.

To perform a firmware update:

1. Copy the RFD file into the MC3300R SD card. One method is through the abd command (abd push <firmware>/sdcard).



**NOTE:** The MC3300R must have USB Debugging enabled in Developer Options for adb commands to work properly.

2. Browse for the firmware RFD file, by clicking on the folder icon.

**NOTE:**

3. Select the required RFD file, from **File View** menu. When the file is selected, the application returns to update screen.

**Figure 44** Transferring Files for Firmware Update

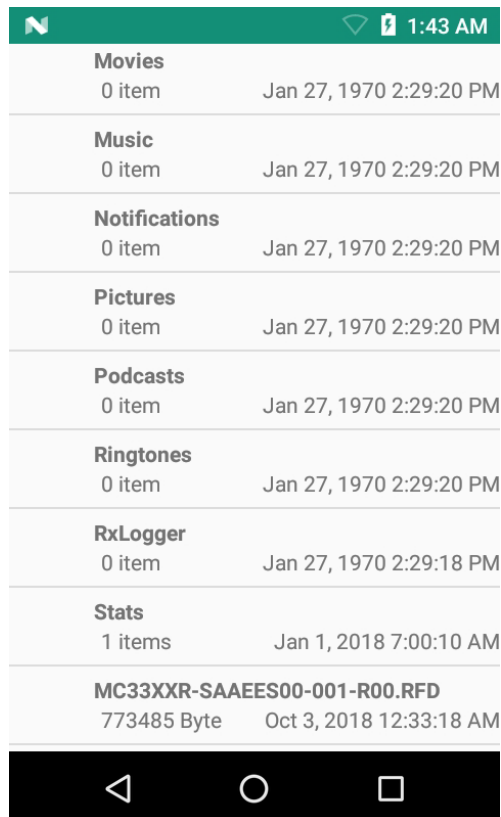

- Click on the **Update** button.

**Figure 45** RFID Manage Firmware Update Screen

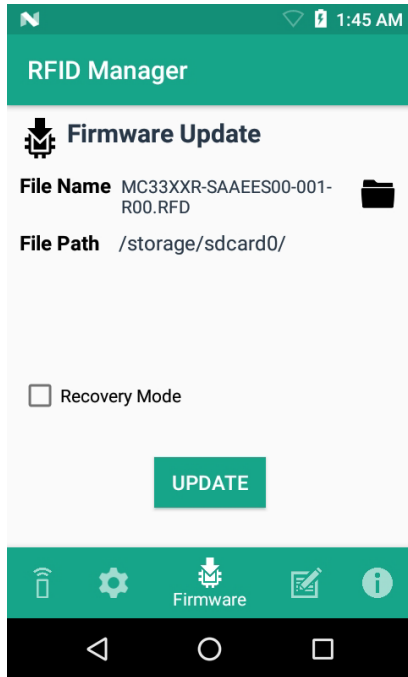

- Once Update is initiated, a status box displays that the firmware updates is in progress. For more information on the current status of the Firmware update (including a progress bar), refer to the Android Notification bar.
- After a successful update, a window displays a MC3300R Firmware Installation Complete message.

**Figure 46** Firmware Update Progress Window

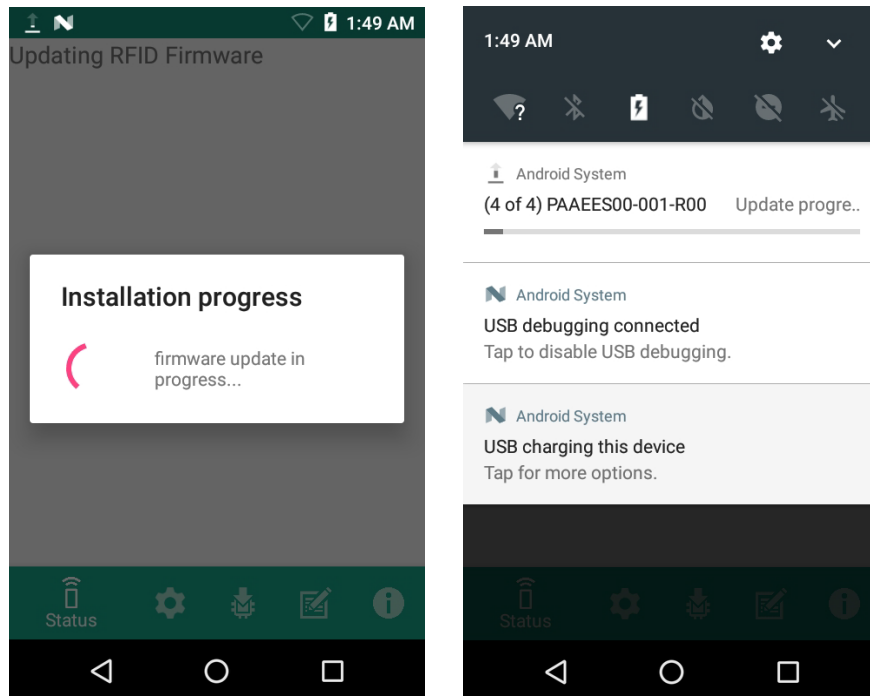

The updated firmware information is displayed on the Information screen.

**Figure 47** Information Screen

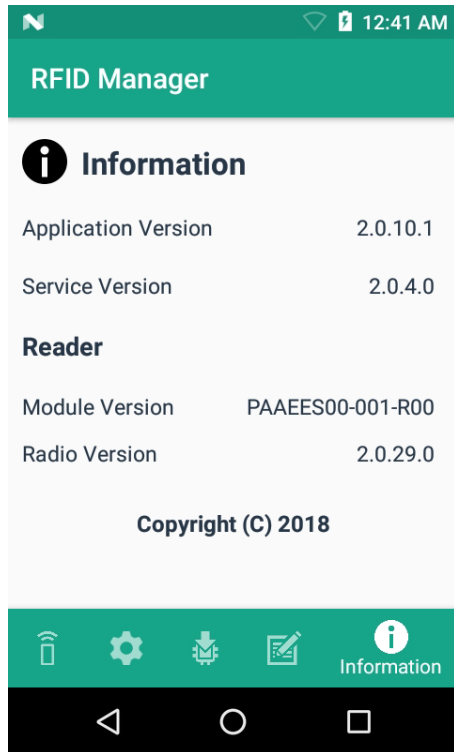

## Recovery Mode

Only select the **Recovery Mode** check box (see [Figure 45 on page 65](#)) if the MC3300R firmware is suspected to be corrupted. Contact the Zebra support team to use the Recovery Mode option.

## RFID Manager Log

The following options may be enabled to capture reader logs.

- **Real-time Logs** - Captures real time logs from the MC3300R RFID radio.
- **Retrieve Buffered Logs** - Captures the buffered logs from the MC3300R RFID radio.
- **Debug Logs** - Captures RFID System Service debug logs.



**NOTE:** All three logs can be enabled. If all three logs are disabled, default logs from the application is captured which does not include MC3300R RFID System Service logs.

**Figure 48** RFID Manager Logger Screen

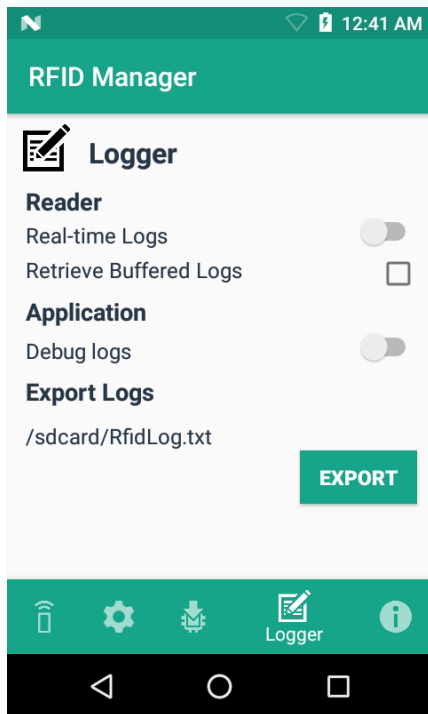

To capture real time logs:

1. Enable **Real-time logs**.
2. Connect and use the RFID application to create logs.
3. Tap on **Export** to retrieve the real time logs. It is not required to disconnect or exit the RFID application.

The Retrieve Buffered Logs option can only be used if the RFID application is not actively reading or writing RFID tags.

The standard RX Logger application can also be used to get RFIDAPI3 and RFIDSERVICE activity.

### Exporting Log Files

To export captured log files, select the **Export** button. The log file is saved as RfidLog.txt at a root of the MC3300R sdcard file system. Retrieve the log file after connecting with PC through adb. RfidLog.txt file is located in the internal storage of the root folder.

# StageNow

---

## Introduction

This chapter provides instruction necessary to generate a RFID Firmware update profile and import RFID CSP plug-in into the StageNow application.

---

## Creating Firmware Update Profile using StageNow

The following provides an example for creating a profile to copy SAADX00-001-N13.rfd from the staging server to the device and then subsequently updating the firmware.

To create a new update firmware profile:

1. Ensure both the device to be staged and the staging server are connected and accessible through the network.
2. Select **Create New Profile** from the side menu.

**Figure 49** Create Firmware Update - CSP Library Screen

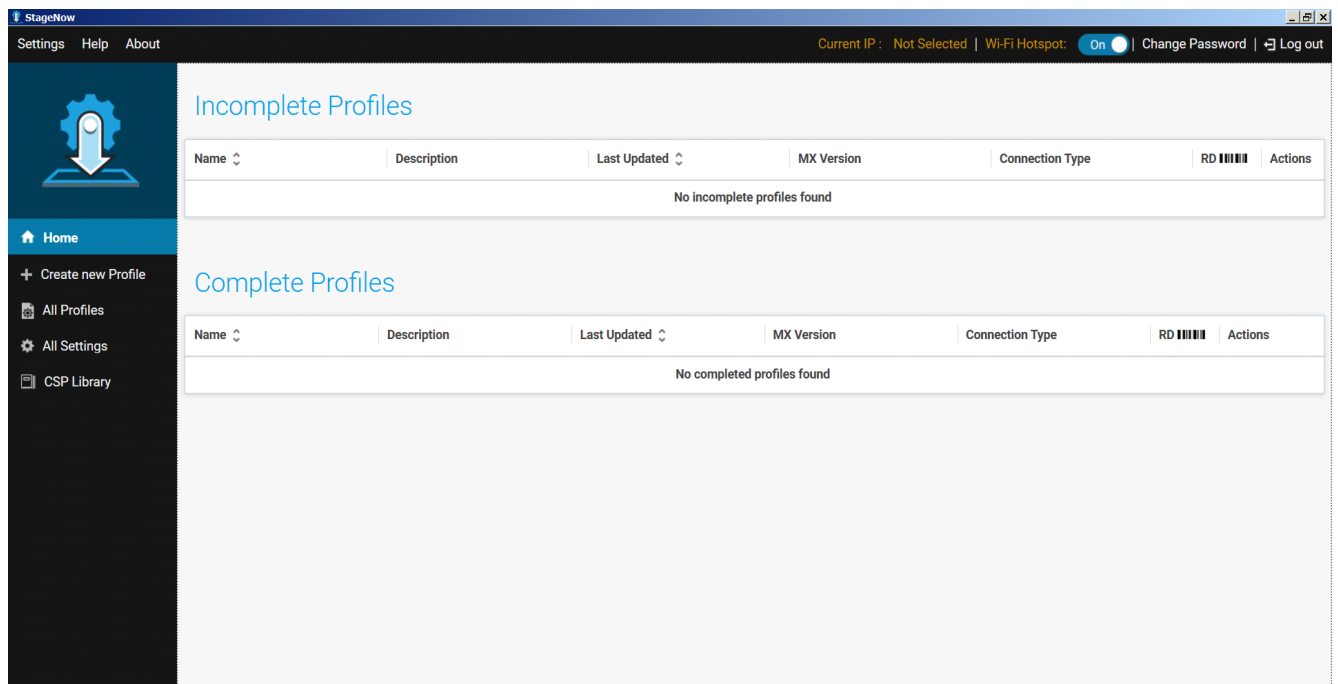



3. Select **XpertMode** and tap on **Create** from the **Select a Wizard** window.

**Figure 50** Wizard Window Selection

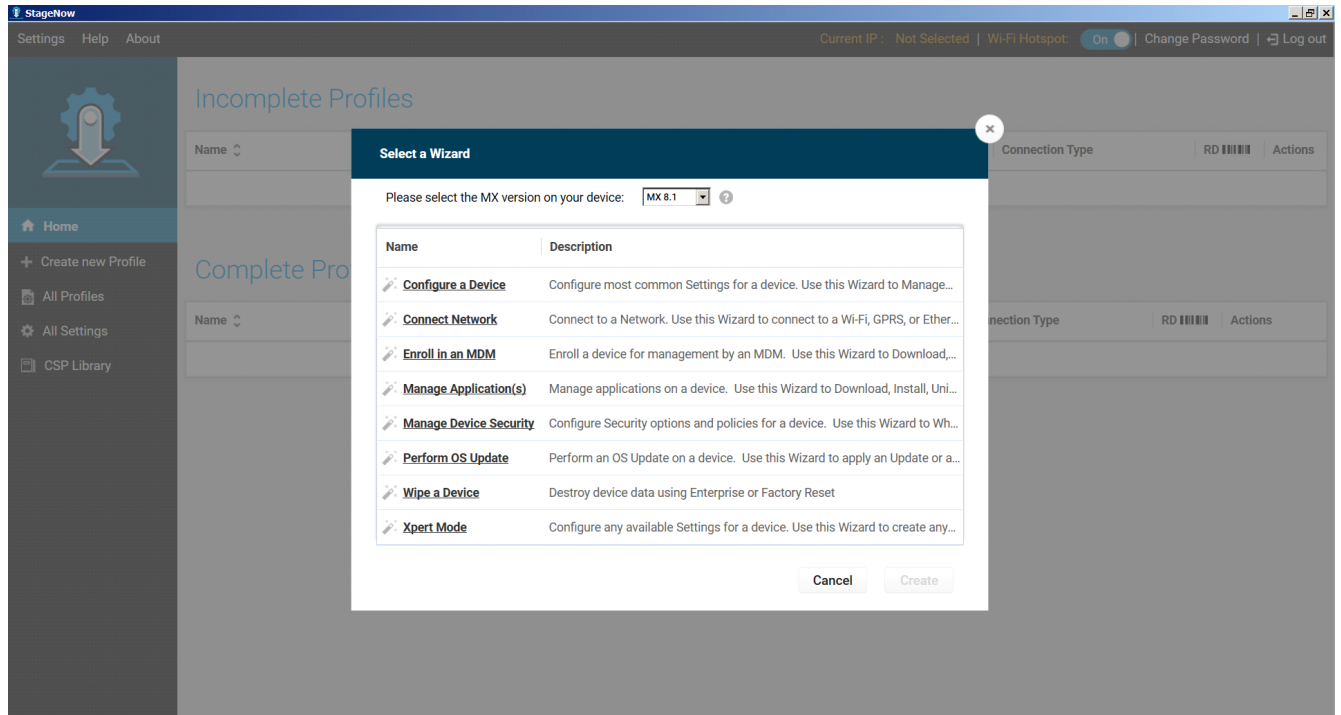

4. Enter a new profile name (For example, Rfid-N13-update as shown in [Figure 90](#)) and tap on **Start**.

**Figure 51** Create Firmware Update - Profile Name

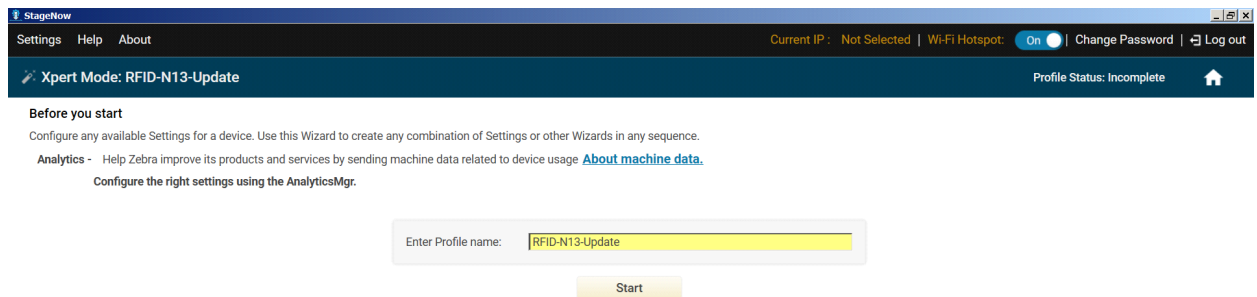

- Click on **Add** to add the **FileMgr CSP** and **rfidmanager CSP**.

**Figure 52** Create Firmware Update - Add Applications

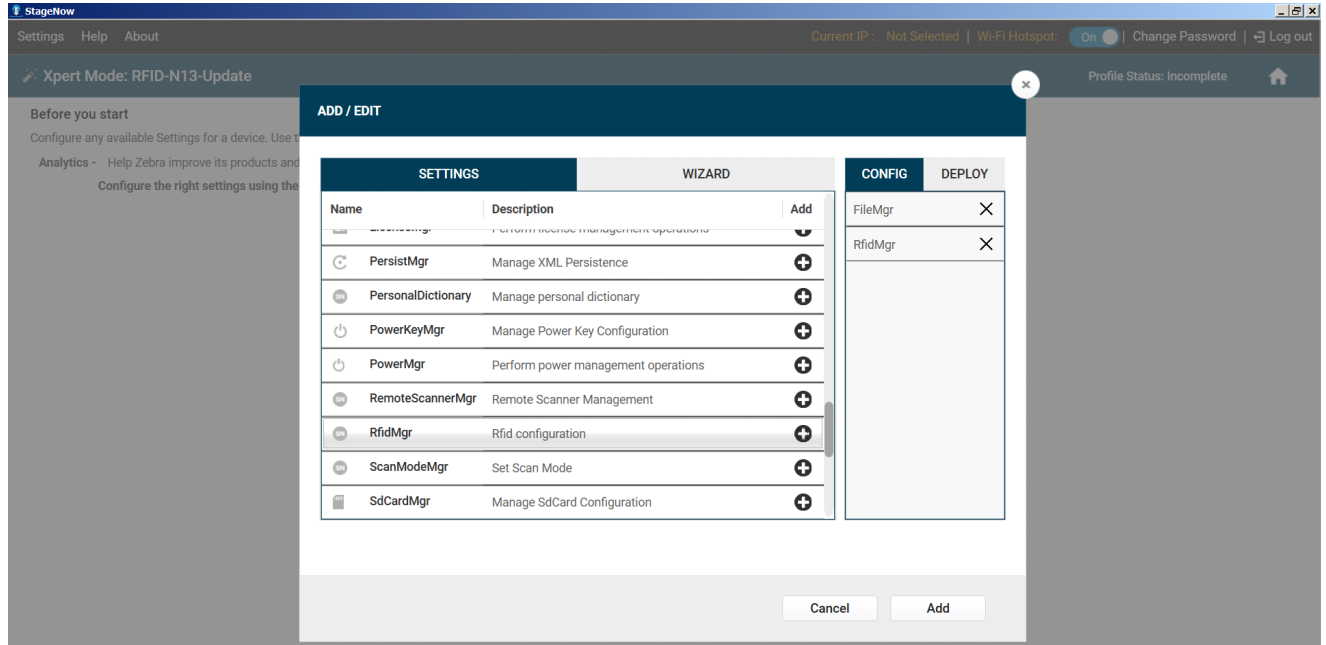

- Enter the **Target Path** (target path in the device) and the **Source File URL** (select the file path in the stagingserver) as shown in [Figure 92](#) and tap **Continue**.

**Figure 53** Create Firmware Update - FileMgr Configurations

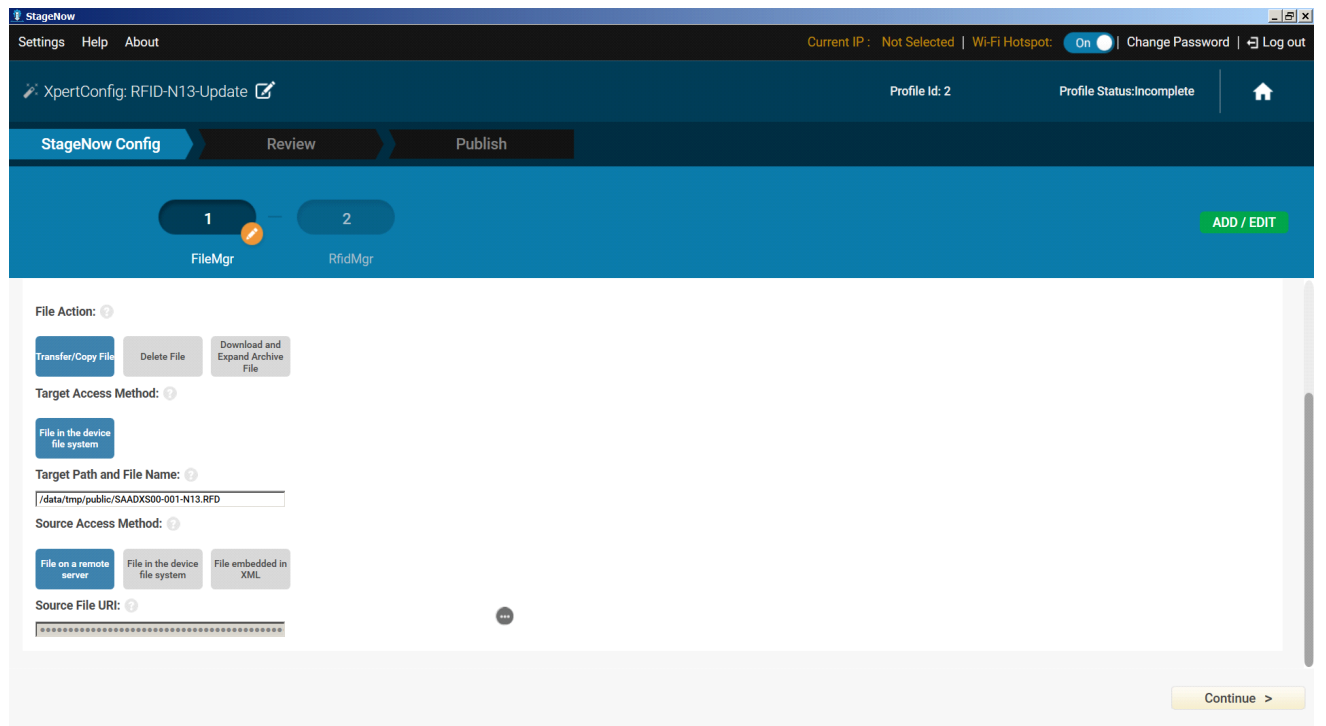

7. Select the **UpdateFirmware** action under RFID action list and enter the Target Path and File Name entered previously (/data/tmp/public/SAADX001-N13D0.rfd) and tap **Continue**.

**Figure 54** Create Firmware Update - RfidManager Configuration

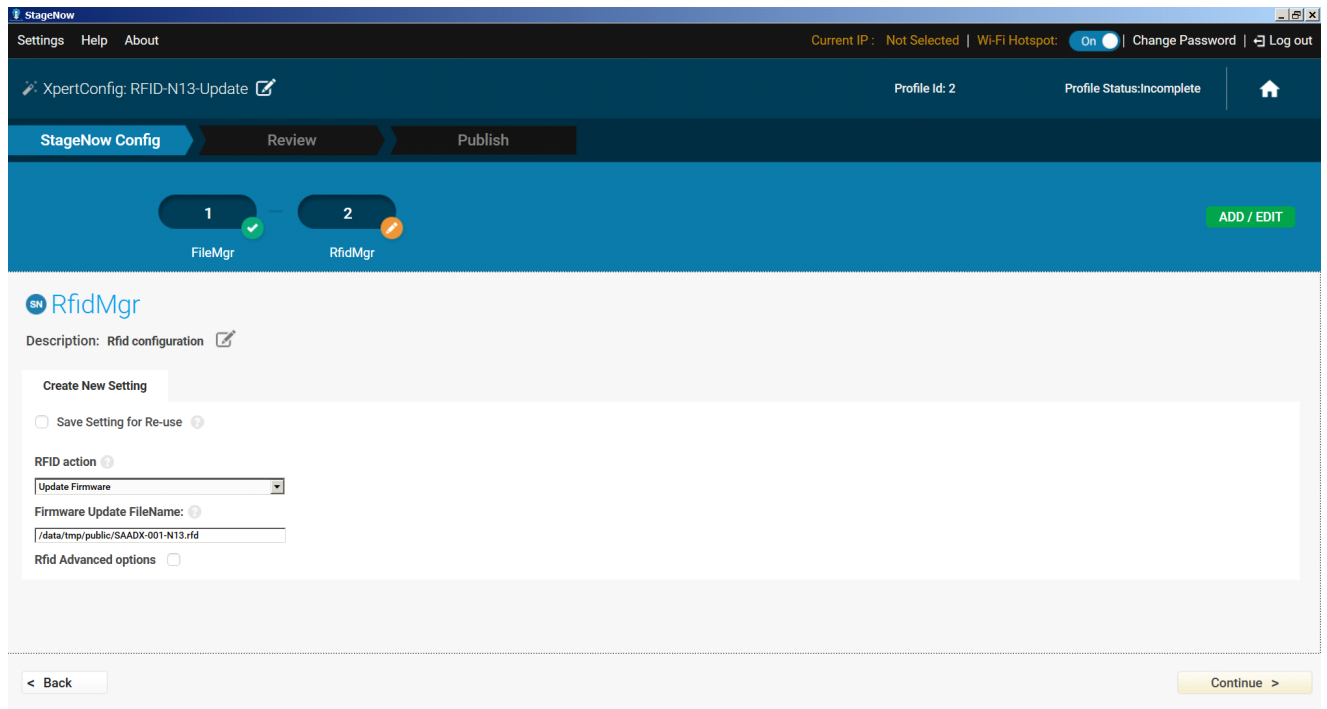

8. Review your input and tap on **Complete Profile**.
9. Select the **Barcode Type** check box required and click on **Test**.

**Figure 55** Create Firmware Update - Barcode selection

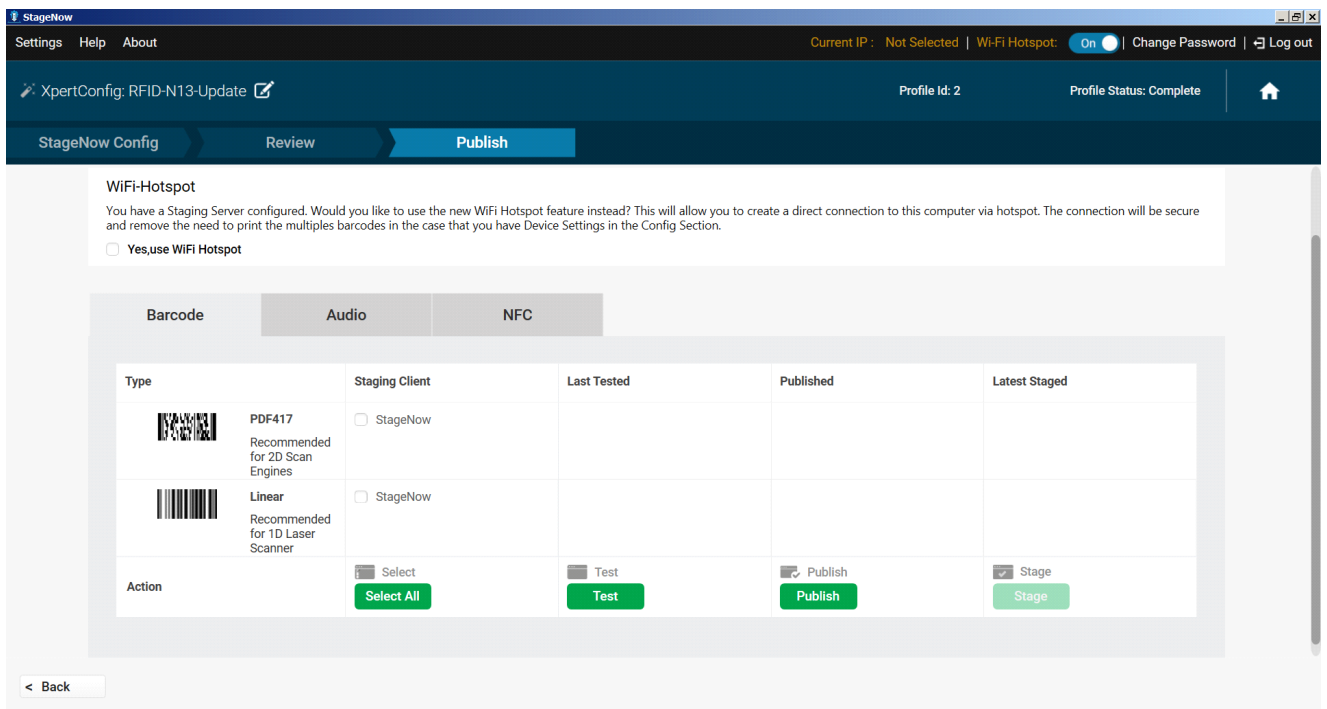

- 10. The test generates a barcode which can be scanned using the StageNow client on the device to stage the firmware.

Figure 56 Stage Firmware Barcode

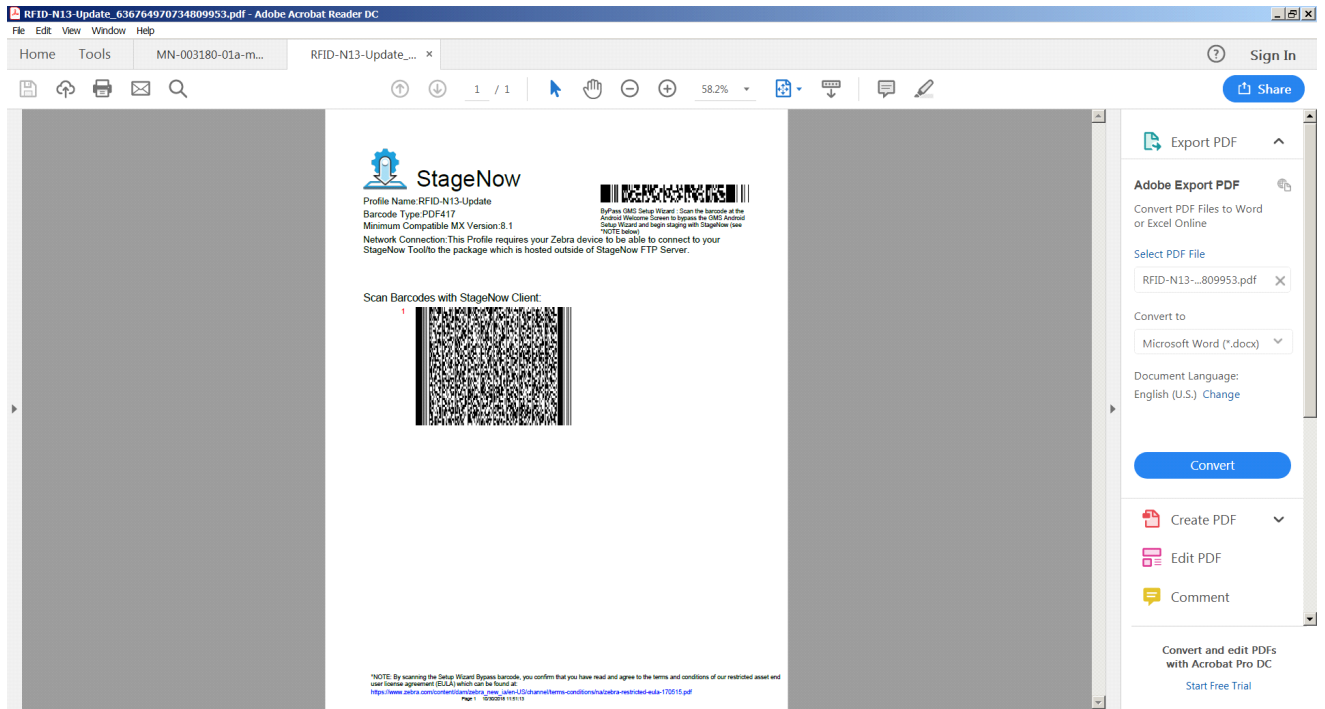

# Import RFID Manager Into StageNow

## Introduction

This chapter provides instruction necessary to generate a RFID Firmware update profile and import RFID CSP plug-in into the StageNow application.

## Creating Firmware Update Profile using StageNow

In the following provides an example for creating a profile to copy SAADXS00-001-N10D0.DAT from the staging server to the device and then subsequently updating the firmware.

To create a new update firmware profile:

1. Ensure both the device to be staged and the staging server are connected and accessible through the network.

**Figure 57** Create Firmware Update-CSP Library Screen

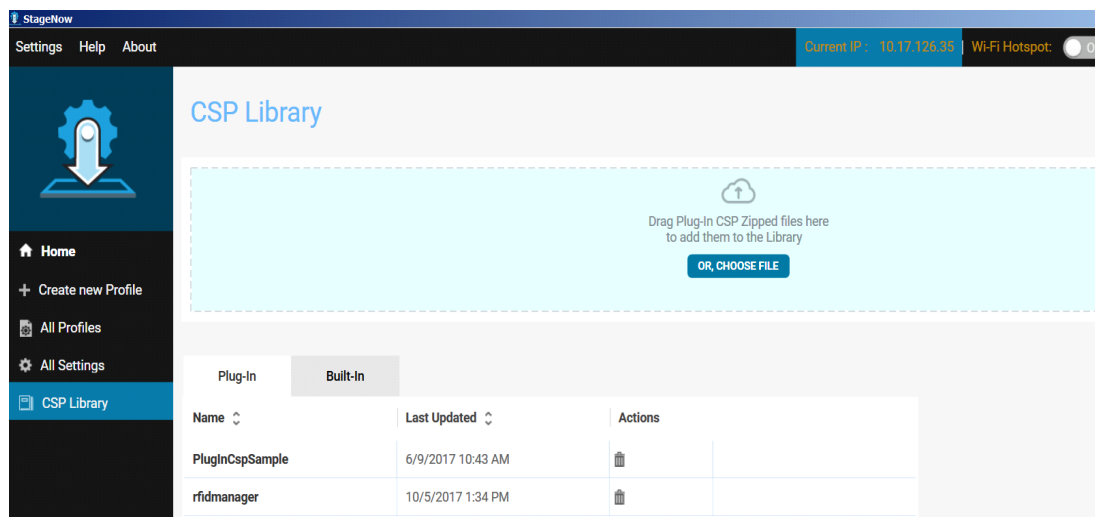

2. Select **Create New Profile** from the side menu.
3. Select **XpertMode** and tap on **Create** from the Select a Wizard window.

**Figure 58** Wizard Window Selection

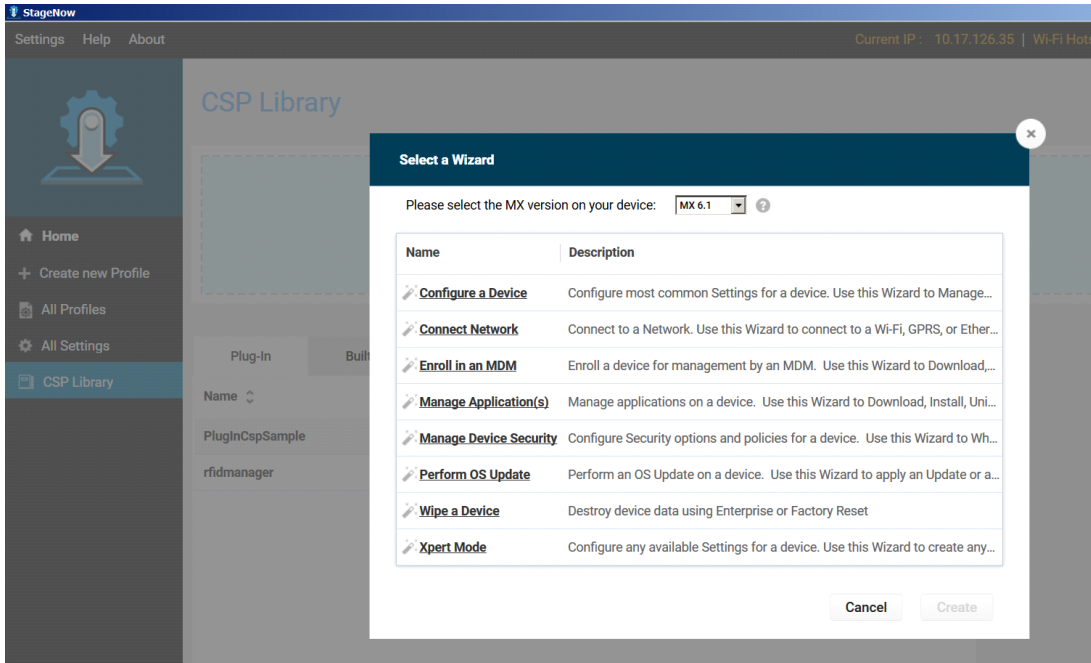

# Import RFID Manager Into StageNow

4. Enter a new profile name (For example, Rfid-N10-update as shown in [Figure 59](#)) and tap on **Start**.

**Figure 59** Create Firmware Update-Profile Name

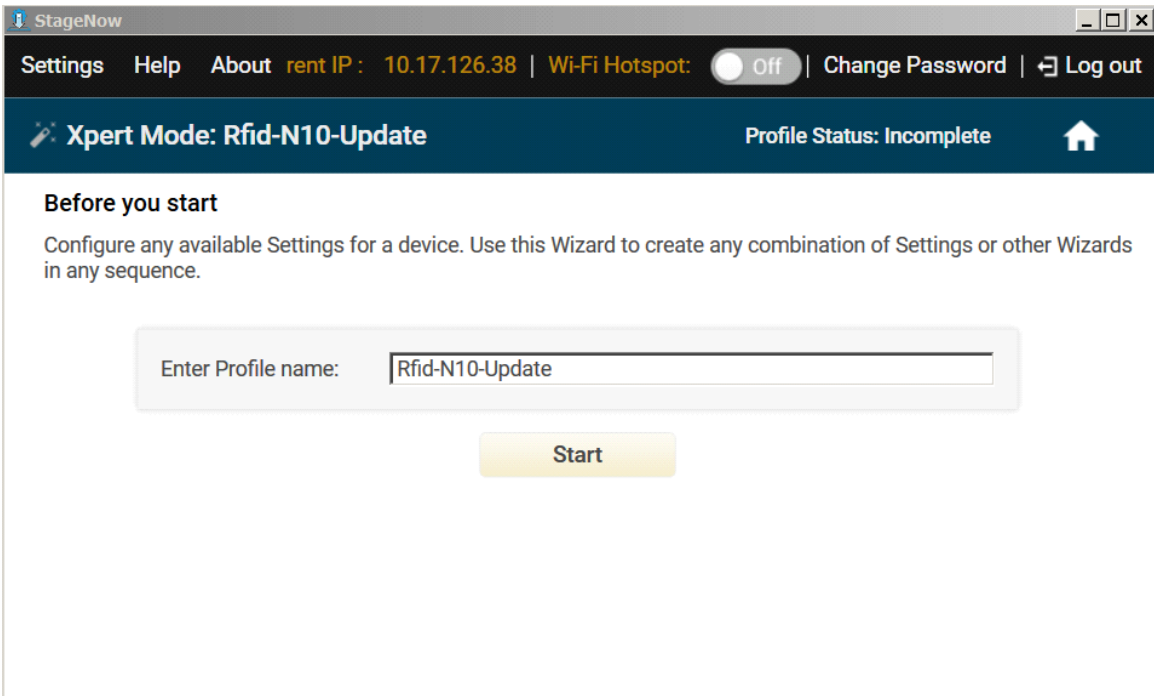

5. Click on **Add** to add the **FileMgr CSP** and **rfidmanager CSP**.

**Figure 60** Create Firmware Update-Add Applications

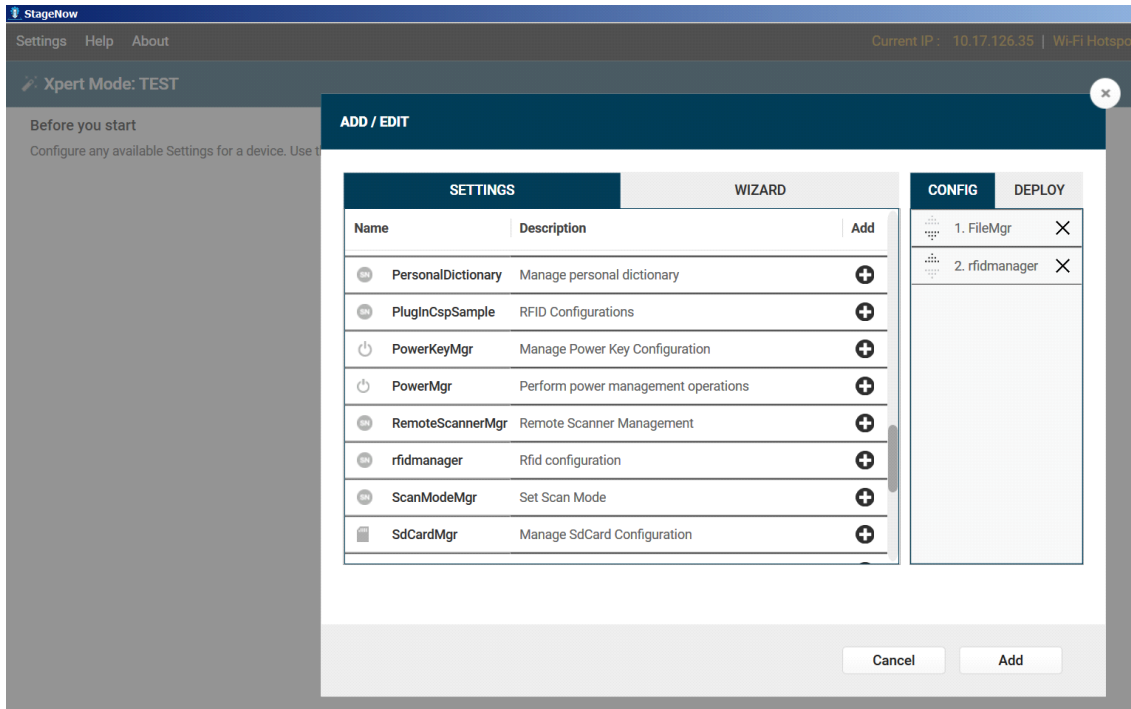

6. Enter the **Target Path** (target path in the device) and the **Source file URL** (select file path in the staging server) as shown in [Figure 61](#) and click Continue.

**Figure 61** Create Firmware Update-FileMgr Configuration

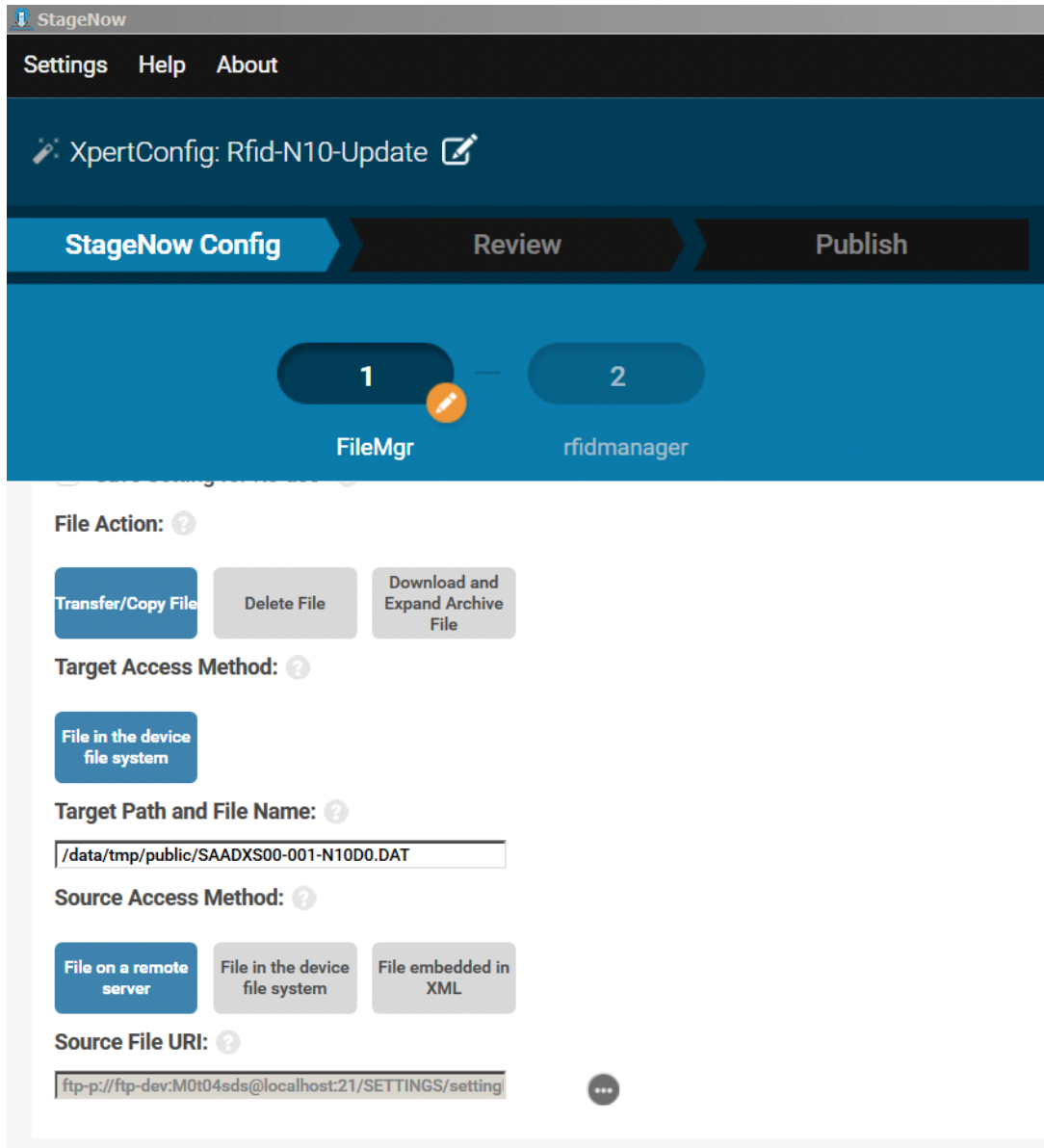



7. Select the **Firmware Update** check-box and enter the **Target Path** and **File Name** entered previously (/data/tmp/public/SAADXS00-001-N10D0.DAT) and tap **Continue**.

**Figure 62** Create Firmware Update-RfidManager Configuration

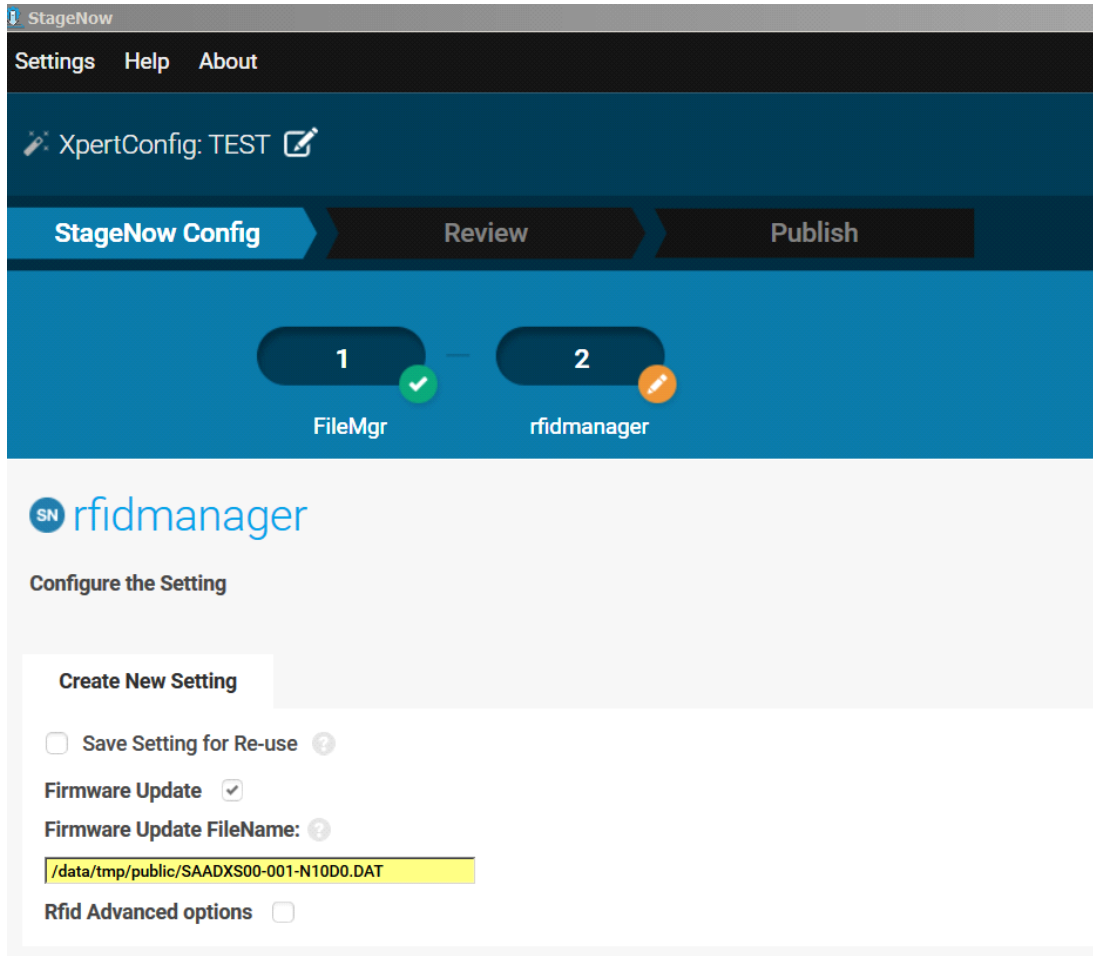

8. Review your input and tap on **Complete** Profile.
9. Select the **Barcode Type** check box required and click on **Test**.

**Figure 63** Create Firmware Update-Barcode selection

WiFi-Hotspot

You have a Staging Server configured. Would you like to use the new WiFi Hotspot feature instead? This will allow you to create a direct connection to this computer via hotspot. The connection will be secure and remove the need to print the multiples barcodes in the case that you have Device Settings in the Config Section.

Yes, use WiFi Hotspot

Barcode		Audio	NFC		
Type		Staging Client	Last Tested	Published	Latest Staged
	PDF417 Recommended for 2D Scan Engines	<input type="checkbox"/> StageNow			
	Linear Recommended	<input type="checkbox"/> StageNow			

< Back

10. Test generates a barcode which can be scanned using the StageNow client on the device to stage the firmware.

Figure 64 Stage Firmware Barcode

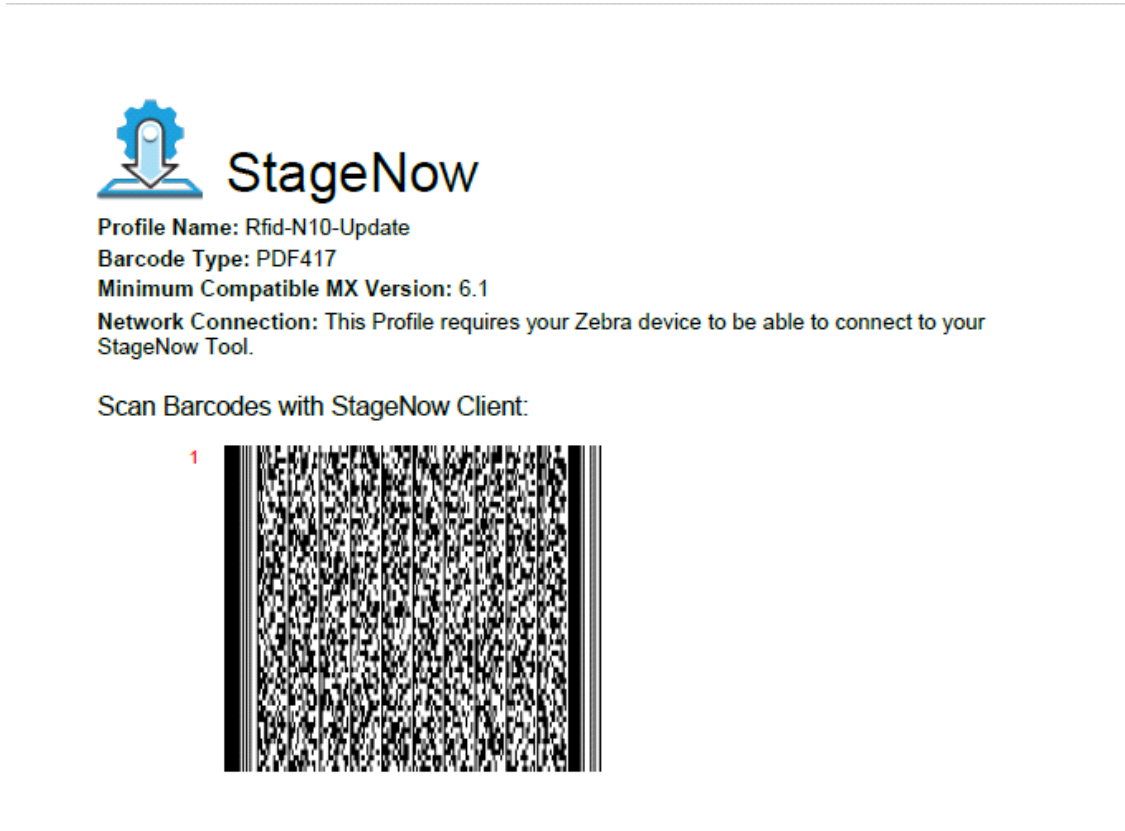

# Troubleshooting

---

## Introduction

This chapter provides troubleshooting solutions for potential problems. For more detailed device and accessory troubleshooting, refer to the MC33XX Mobile Computer Integrator Guide at: [www.zebra.com/support](http://www.zebra.com/support).

---

## Troubleshooting the MC3300R

**Table 11** Troubleshooting the MC3300R

Symptom	Possible Cause	Action
RFID Reader does not read tags.	The RF region configuration is not set.	Use the RFID Manager application to set the regulatory region or country operation per the application instructions.
RFID Reader version is not displayed in RFID Manager.	Recovery mode is enabled.	Reboot device.
RFID Reader is responsive but cannot read tags.	Battery is critically low. Reader does not function if battery level is less than or equal to 5%.	Place the RFID reader in the charging cradle until the battery is charged.

# Technical Specifications

---

## Introduction

The following sections provide technical specification for the device.

---

## MC3300R Technical Specifications

The following table summarizes the MC3300R's intended operating environment and technical hardware specifications.

**Table 12** MC3300R Technical Specifications

Item	Description
<b>Physical Characteristics</b>	
Dimensions	MC3330R: 6.45 in. L x 2.95 in. W x 8.31 in. D 164 mm L x 75 mm W x 211 mm D  MC3390R: 6.45 in. L x 3.78 in. W x 10.67 in. D 164 mm L x 96 mm W x 271 mm D
Weight (with extended battery)	MC3330R with SE4750: 665 g MC3390R with SE4750: 740 g MC3390R with SE4850: 765 g
Display	4.0 inch capacitive; WVGA; color
Imager Window	Corning® Gorilla® Glass
Touch Panel	Corning® Gorilla® Glass touch panel w/air gap
Backlight	LED backlight
Battery	Extended Life: Rechargeable Lithium-Ion 5200 mAh minimum (3.7V)
Expansion Slot	User accessible microSD slot. Supports up to 32 GB microSDHC.

## Specifications

**Table 12** MC3300R Technical Specifications (Continued)

Item	Description
Network Connections	USB 2.0 High Speed (host and client), WLAN and Bluetooth
Notification	Side LEDs and audible tone.
Keypad Options	29-key Numeric 38-key Function Numeric (calculator-style integrated numeric keypad) 47-key Alpha-Numeric (calculator-style integrated numeric keypad)
Voice	PTT Voice Support (Internal Speaker)
Audio	Speaker
<b>Performance Characteristics</b>	
CPU	Qualcomm 8056 1.8 GHz hexa-core 64-bit with power optimization
Operating System	Android 8.1 Oreo
Memory	4 GB RAM/32 GB Flash.
Output Power (USB)	USB: 5 VDC @ 500 mA max.
<b>User Environment</b>	
Operating Temperature	-20°C to 50°C (-4°F to 122°F)
Storage Temperature	-40°C to 70°C (-40°F to 158°F) without battery
Charging Temperature	0°C to 40°C (32°F to 104°F)
Humidity	5% to 95% RH non-condensing
Drop Specification	Multiple 1.5 m (5 ft.) drops to concrete over the entire operating temperature range.
Tumble Specification	1,000 1.6 ft./0.5 m tumbles (hits)
Sealing	IP54
Vibration	5 Hz to 2 KHz
Thermal Shock	-40°C to 70°C (-40°F to 158°F)
Electrostatic Discharge (ESD)	±20 kVdc air discharge, ± 10 kVdc contact discharge
<b>Wireless LAN Data Communications</b>	
Wireless Local Area Network (WLAN) radio	IEEE® 802.11a/b/g/n/ac/d/h/i/k/r/w
Data Rates Supported	2.4 GHz: 144 Mbps 5 GHz: 867 Mbps
Operating Channels	Chan 36 - 165 (5 GHz), Chan 1 - 13 (2.4 GHz); actual operating channels/frequencies depend on regulatory rules and certification agency.

## Specifications

**Table 12** MC3300R Technical Specifications (Continued)

Item	Description
Security and Encryption	<p><b>Security Modes:</b> WPA and WPA2 (Personal or Enterprise)</p> <p><b>Encryption:</b> WEP40/WEP104, TKIP and AES</p> <p><b>Authentication:</b> EAP-TLS; EAP-TTLS (MSCHAP, MSCHAPv2, PAP); PEAP (MSCHAPv2, EAP-GTC); LEAP</p> <p><b>Other:</b> Wi-Fi certified, and supports IPv6</p>
Certifications	802.11n/ac, WMM-PS, WMM-AC, PMF, Voice Enterprise, Wi-Fi Direct, WPS
Fast Roam	PMKID/OKC/CCKM/802.11r
<b>Wireless PAN Data</b>	
Bluetooth	V4.1, V2.1 + EDR w/ Bluetooth Low Energy (BLE). Class 2
<b>Data Capture</b>	
Scanning	SE4750-SR 2D, SE4750-MR 2D, SE4850-ER
<b>2D Imager Engine (SE4750) Specifications</b>	
Field of View	Horizontal - 48.0° Vertical - 36.7°
Image Resolution	1280 horizontal X 960 vertical pixels
Roll	360°
Pitch Angle	+/- 60° from normal
Skew Tolerance	+/- 60° from normal
Ambient Light	Sunlight: 10,000 ft. candles (107,639 lux)
Focal Distance	From front of engine: 17.7 cm (7.0 in.)
Laser Aiming Element	Visible Laser Diode (VLD): 655 nm +/- 10 nm Central Dot Optical Power: 0.6 mW (typical) Pattern Angle: 48.0° horizontal, 38.0° vertical
Illumination System	LEDs: Warm white LED Pattern Angle: 80° at 505 intensity
<b>2D Extended Range Imager Engine (SE4850) Specifications</b>	
Field of View	Near camera: Horizontal - 32.0°, Vertical 20° Far camera: Horizontal - 12°, Vertical - 7.6°
Image Resolution	1280 horizontal X 800 vertical pixels
Roll	360°
Pitch Angle	+/- 60° from normal
Skew Tolerance	+/- 60° from normal

## Specifications

**Table 12** MC3300R Technical Specifications (Continued)

Item	Description
Ambient Light	Sunlight: 10,000 ft. candles (107,639 lux)
Laser Aiming Element	Laser Wavelength: 655 nm Central Dot Optical Power: 0.6 mW (Class 2 IEC60825:2014)
Illumination System	LEDs: Hyper Red 660nm
<b>Supported Symbologies</b>	
1D	Chinese 2 of 5, Codabar, Code 11, Code 128, Code 39, Code 93, Discrete 2 of 5, EAN-8, EAN-13, GS1 DataBar, GS1 DataBar Expanded, GS1 DataBar Limited, Interleaved 2 of 5, Korean 2 of 5, MSI, TLC 39, Matrix 2 of 5, Trioptic, UPCA, UPCE, UPCE1, Web Code.
2D	Australian Postal, Aztec, Canadian Postal, Composite AB, Composite C, Data Matrix, Dutch Postal, Japan Postal, Maxicode, Micro PDF, Micro QR, PDF, QR Code, UK Postal, US Planet, US Postnet, US4State, US4State FICS.



# Index

## Numerics

123RFID mobile application	57
1-slot USB charge cradle	21
20-slot spare battery charger	41
4-slot spare battery charger	39
5-slot charge only cradle	24
5-slot cradle with 4-slot battery charger	32
5-slot ethernet cradle	26
5-slot ethernet cradle with 4-slot battery charger	34

## A

accessories	16
belt strap	51
fabric holster	51
shoulder strap	51
adapter	
installation	47

## B

battery	
4-slot battery charging	33
5-slot battery charging	24
battery comparison	20
battery compatibility	20
charging	21
charging 1-slot	23
spare battery charging	22

## C

charge only adapter	47
charging	
5-slot sharecradle	24
compatibility	20
configurations	7
cradles	
daisy-chaining ethernet cradles	35

## D

documents	11
-----------	----

## E

ethernet	
configure static IP address	29
configuring ethernet	28
establish connection	30

## F

feedback	12
----------	----

## L

label	12
led	
indicators	31

## M

manufacturing Label	12
mc3300r	
initial setup	15
technical specifications	81

## R

revision history	3
rfid	
antenna	14
components	14
radio module	14
tags	14
technology overview	13
rfid manager	58
client application status	60
connection status	58
exporting log files	67
firmware update	64

recovery mode .....	66
rfid manager log .....	67
rfid regulatory .....	61
settings .....	62
using rfid manager .....	58
rfid sled	
troubleshooting .....	80
rubber boot - MC33XX-G .....	50

## S

sharecradles	
daisy-chaining cradles .....	27
software .....	11
stagenow .....	68
firmware update profile .....	73

## T

troubleshooting .....	80
-----------------------	----

## U

USB charge cable .....	43
------------------------	----

## Z

Zebra RFID mobile application .....	57
-------------------------------------	----

