



Dolphin™ CT60

powered by Android™

Quick Start Guide

Out of the Box

Make sure that your shipping box contains these items:

- Dolphin CT60 mobile computer (Model CT60LON or CT60L1N)
- Rechargeable 3.85 VDC Li-ion battery
- Product documentation

If you ordered accessories for your mobile computer, verify that they are also included with the order. Be sure to keep the original packaging in case you need to return the mobile computer for service.

Note: *CT60LON models do not include a WWAN radio.*

Memory Card Specifications

Honeywell recommends the use of Single Level Cell (SLC) industrial grade microSD™ or microSDHC™ memory cards with Dolphin mobile computers for maximum performance and durability. Contact a Honeywell sales representative for additional information on qualified memory card options.

Mobile Computer Features

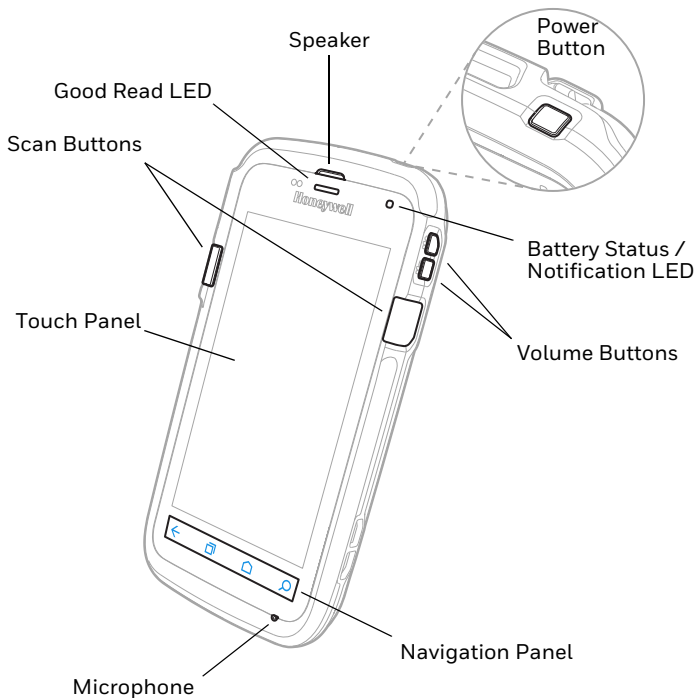

Note: Hand strap not shown.

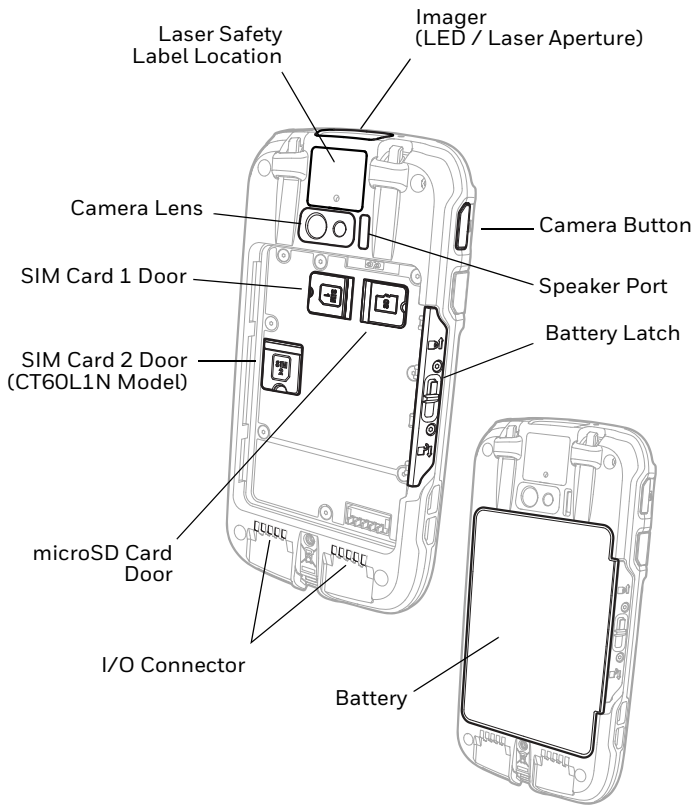

Install a microSD Card (SD)

Note: Format the microSD card before initial use.

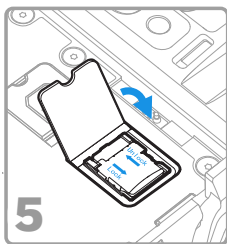
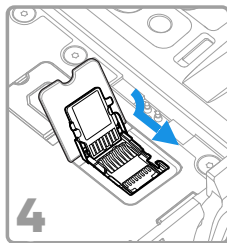
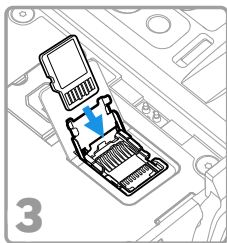
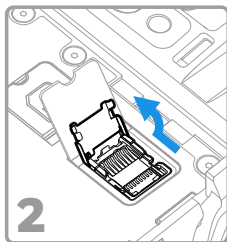
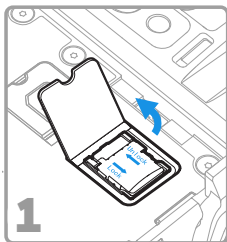

Note: Always power off the computer and remove the battery before attempting to install or remove a card.

Install a microSIM Card (SIM 1)

Phone feature is available only on CT60L1N models.

On all models, when using a UICC card for NFC Secure Element link encryption, install the card in SIM slot 1.

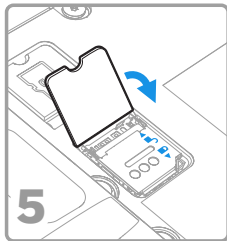
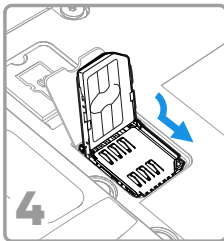
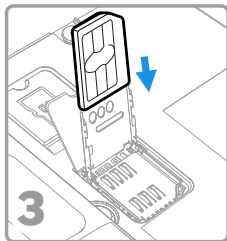
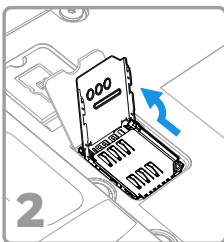
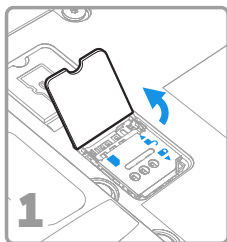

Note: Always power off the computer and remove the battery before attempting to install or remove a card.

Install a Secondary microSIM Card (SIM 2)

Note: Feature available on CT60L1N Models only.

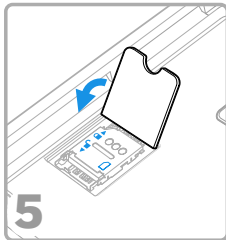
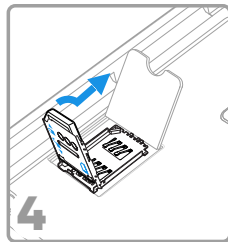
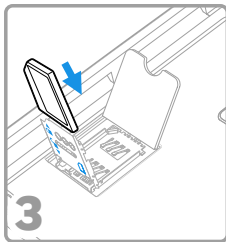
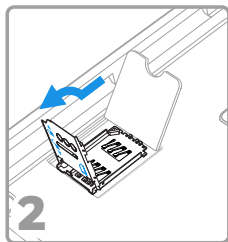
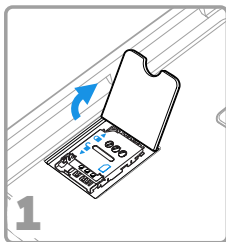

Note: Always power off the computer and remove the battery before attempting to install or remove a card.

Install the Battery

The CT60 mobile computer ships with a Li-ion 3.85 VDC, 15.5 watt-hour battery manufactured for Honeywell International Inc.



We recommend use of Honeywell Li-ion battery packs. Use of any non-Honeywell battery may result in damage not covered by the warranty.

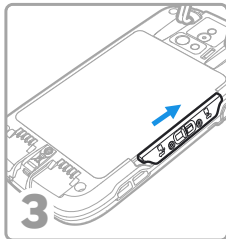
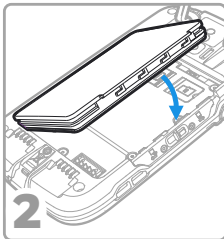
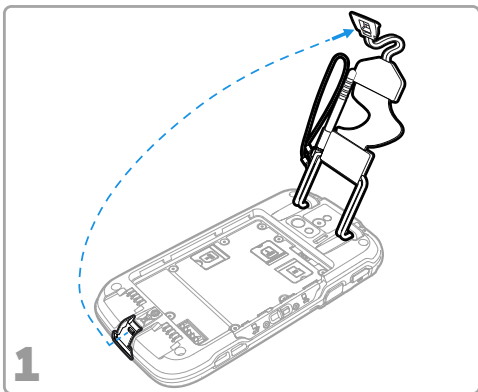



Ensure all components are dry prior to placing the battery in the computer. Mating wet components may cause damage not covered by the warranty.

Charge the Mobile Computer

The CT60 mobile computer ships with a partially charged battery. Charge the battery with a CT50 Series charging device for a minimum of **4 hours**. Using the computer while charging the battery increases the time required to reach a full charge.



We recommend the use of Honeywell accessories and power adapters. Use of any non-Honeywell accessories or power adapters may cause damage not covered by the warranty.

CT60 mobile computers are designed for use with the following CT50 Series charging accessories: HomeBase, Ethernet HomeBase, ChargeBase, NetBase, Quad Battery Charger, Vehicle Power Adapter, Vehicle Dock, and USB Adapter.



Ensure all components are dry prior to mating the computers and batteries with peripheral devices. Mating wet components may cause damage not covered by the warranty.

Turn Power On/Off

The first time you power on the computer, a Welcome screen appears. You can either scan a configuration bar code or use the Wizard to manually set up the computer. Once setup is complete, the Welcome screen no longer appears on startup and Provisioning mode is automatically turned off (disabled).

To turn the computer on:

- Press and hold the **Power** button for approximately 3 seconds, and then release.

To turn the computer off:

1. Press and hold the **Power** button until the options menu appears.
2. Touch **Power off**.

Battery Replacement

Before removing the battery, always do one of the following:

- Power off the computer.
- Place the unit in Swap Battery mode (feature availability is model dependent).

Swap Battery Mode

Swap Battery mode places the computer in a low power state so that the battery can be removed for a short time. This feature is not available on all models.

To activate Swap Battery mode:

1. Press and hold the **Power** button until the options menu appears.
2. Touch **Swap Battery** and follow the on-screen instructions.
3. Once you replace the battery, press the **Power** button.



Sleep Mode

Sleep mode automatically turns the touch panel display off and locks the computer to save battery power when the computer is inactive for a programmed period of time.

1. Press and release the **Power** button to wake the computer.
2. Drag the  toward the top of the display to unlock the computer.

Adjust the Display Sleep Time

To adjust the amount of time before the display sleeps after inactivity:





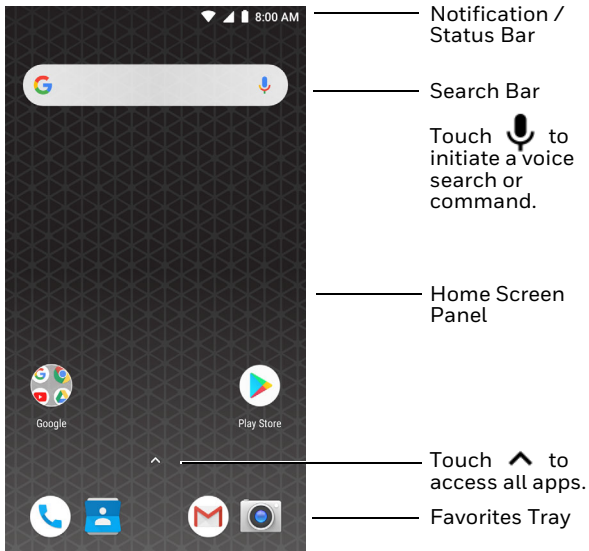

1. Touch  > **Settings** > **Display** > **Advanced** > **Sleep**.
2. Select the amount of time before the display goes to sleep.
3. Touch  to return to the Home screen.

About the Home Screen

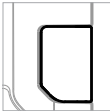

To learn how to customize the Home screen, see the user guide.

Navigation and Function Buttons

Button	Description	
	Back	Return to the previous screen.
	Recent Apps	View and switch between recently used apps.
	Home	Return to the Home screen.
	Search	Start a search on the computer or the Internet.
	Volume	Raise or lower the volume of the speaker.
	Scan	Press right or left scan button to trigger the scanner.
	Camera	Press to open the camera app and take a photo.

To learn more about how to re-map a button, see the user guide.

About Provisioning Mode

After completing the out-of-box set up process, Provisioning mode is automatically turned off. Scanning a bar code to install applications, certificates, configuration files, and licenses on the computer is restricted unless you enable Provisioning mode in the Settings app. To learn more, see the user guide.

Scan a Bar Code with the Scan Demo

Note: For optimum performance, avoid reflections by scanning the bar code at a slight angle.

1. Touch **^** > **Demos** > **Scan Demo**.
2. Point the computer at the bar code.
3. Touch **Scan** on the touch screen or press and hold a **Scan** button. Center the aiming beam over the bar code.

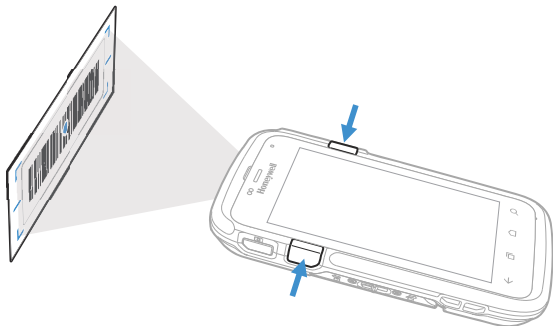

The decode results appear on the screen.

Note: *In the Scan Demo app, not all bar code symbologies are enabled by default. If a bar code does not scan, the correct symbology may not be enabled. To learn how to modify the default app settings, see the user guide.*

Sync Data

To move files between your CT60 and a computer:

1. Connect the CT60 to your computer using a USB charge/communication accessory.
2. On the CT60, swipe down from the top of the screen to see the notifications panel.
3. Touch the Android System USB Connection notification twice, to open the options menu.
4. Select either **Transfer files** or **Transfer photos (PTP)**.
5. Open the file browser on your computer.
6. Browse to the CT60. You can now copy, delete and move files or folders between the computer and CT60 as you would with any other storage drive (e.g., cut and paste or drag and drop).

Note: *When Provisioning mode is turned off, some folders are hidden from view in the file browser.*

Restart the Mobile Computer

You may need to restart the mobile computer to correct conditions where an application stops responding to the system or the computer seems to be locked up.

1. Press and hold the **Power** button until the options menu appears.
2. Select **Reboot**.

To restart the computer if the touch panel display is unresponsive:

- Press and hold the **Power** button for approximately 8 seconds until the computer restarts.

Note: *If you try to restart the computer and still experience issues, you may need to see the user guide for information on how to perform a Factory Reset (Clean Boot).*

Support

To search our knowledge base for a solution or log into the Technical Support Portal and report a problem, go to www.hsmcontactsupport.com.

Documentation

Product documentation is available at www.honeywellaidc.com.

Limited Warranty

For warranty information, go to www.honeywellaidc.com and click **Get Resources > Product Warranty**.

Patents

For patent information, see www.hsmpats.com.

Trademarks

Android is a trademark of Google LLC.

Disclaimer

Honeywell International Inc. (“HII”) reserves the right to make changes in specifications and other information contained in this document without prior notice, and the reader should in all cases consult HII to determine whether any such changes have been made. The information in this publication does not represent a commitment on the part of HII.

HII shall not be liable for technical or editorial errors or omissions contained herein; nor for incidental or consequential damages resulting from the furnishing, performance, or use of this material. HII disclaims all responsibility for the selection and use of software and/or hardware to achieve intended results.

This document contains proprietary information that is protected by copyright. All rights are reserved. No part of this document may be photocopied, reproduced, or translated into another language without the prior written consent of HII.

Copyright © 2018-2019 Honeywell International Inc. All rights reserved.