

75 Series

Mobile Computer Powered by Android® 6
CN75, CN75e, CN75 NI, CN75e NI, CK75



User Guide

Disclaimer

Honeywell International Inc. (“HII”) reserves the right to make changes in specifications and other information contained in this document without prior notice, and the reader should in all cases consult HII to determine whether any such changes have been made. The information in this publication does not represent a commitment on the part of HII.

HII shall not be liable for technical or editorial errors or omissions contained herein; nor for incidental or consequential damages resulting from the furnishing, performance, or use of this material. HII disclaims all responsibility for the selection and use of software and/or hardware to achieve intended results.

This document contains proprietary information that is protected by copyright. All rights are reserved. No part of this document may be photocopied, reproduced, or translated into another language without the prior written consent of HII.

Copyright © 2017 Honeywell International Inc. All rights reserved.

Web Address: www.honeywellaidc.com

Android, Google, and other marks are trademarks of Google Inc.

Microsoft, Windows, and Internet Explorer are either registered trademarks or registered trademarks of Microsoft Corporation in the United States and/or other countries.

Bluetooth is a trademark of Bluetooth SIG, Inc., U.S.A.

Wi-Fi is a registered certification mark of the Wi-Fi Alliance.

This product includes software developed by the OpenSSL Project for use in the OpenSSL Toolkit (www.openssl.org).

Other product names or marks mentioned in this document may be trademarks or registered trademarks of other companies and are the property of their respective owners.

For patent information, refer to www.hsmpats.com.

TABLE OF CONTENTS

| | |
|---|----------|
| Customer Support | vii |
| Technical Assistance | vii |
| Product Service and Repair | vii |
| Limited Warranty | vii |
| Send Feedback | vii |
| Chapter 1 - About the Computer Features..... | 1 |
| About the 75 Series Mobile Computers | 1 |
| Overview of 75 Series Features | 1 |
| About the Battery | 5 |
| Charge the Battery | 5 |
| About the I/O Cover on Non-Incendive Models | 6 |
| About Battery Replacement | 8 |
| About Battery Status | 10 |
| Set the Battery Status LED Activity | 11 |
| About Battery Life and Conservation | 12 |
| Enable Airplane Mode | 12 |
| About the Status LEDs | 13 |
| About the Keypad | 14 |
| About the Keypad Backlight | 16 |
| About the Color-Coded Keys | 16 |
| Enter Characters on the QWERTY Keypad | 17 |
| Enter Characters on the Numeric Keypad | 17 |
| Enter Characters on the CK75 Keypads | 18 |
| About the Power Button..... | 19 |

| | |
|---|----|
| About the Screen Backlight and Sleep Mode | 19 |
| Configure the Screen Brightness..... | 20 |
| Configure Sleep Mode..... | 20 |
| About the CK75 Cold Storage Model Heater | 20 |
| How Automatic Mode Works..... | 21 |
| How Preemptive Mode Works | 21 |
| How to Manually Turn the Heaters On/Off..... | 22 |
| Configure the Heater Feature | 22 |
| About Audio Features..... | 25 |
| Adjust the Speaker Volume | 25 |
| Enable Vibrate Mode..... | 26 |
| Configure Audio Settings | 26 |
| Insert a MicroSD Card..... | 27 |
| Install a MicroSD Card in a CN75 or CN75e | 27 |
| Install a MicroSD Card in a CK75 | 29 |
| How to Transfer Files..... | 32 |
| Configure USB Connection and Transfer Files | 32 |
| 70 Series Accessories..... | 33 |

Chapter 2 - About the User Interface and Applications 35

| | |
|---|----|
| About the User Interface..... | 35 |
| About the Home Screen..... | 35 |
| Notification and Status Icons..... | 37 |
| About Screen Gestures | 38 |
| About Honeywell Applications..... | 39 |
| Applications Available on the Computer | 39 |
| Applications You Can Download to the Mobile Computer..... | 40 |
| Unlock Developer Options | 41 |

Chapter 3 - Use the Imager 43

| | |
|--|----|
| About the Imager | 43 |
| How to Scan Bar Codes as Keyboard Input..... | 43 |
| Change the Scanner Settings | 44 |

| | |
|--|----|
| Restore Default Scanner Settings..... | 44 |
| Add a Scanning Profile..... | 44 |
| Delete a Scanning Profile..... | 45 |
| Scan Bar Codes..... | 45 |
| Use the Scan Demo App..... | 46 |
| How to Change the Default Symbology Settings in the App..... | 46 |
| Use the Imager as a Flashlight..... | 47 |

Chapter 4 - Use the Phone.....49

| | |
|---|----|
| About the Phone..... | 49 |
| How to Add and Switch Between Network Carriers..... | 49 |
| Activate the UMTS Phone..... | 50 |
| Activate the CDMA Phone..... | 52 |
| Make a Phone Call..... | 52 |
| Answer a Phone Call..... | 53 |
| Make an Emergency Phone Call..... | 53 |
| Configure Phone Settings..... | 53 |

Chapter 5 - Use the Camera55

| | |
|--|----|
| About the Color Camera..... | 55 |
| Take a Picture..... | 55 |
| Change Basic Camera Settings..... | 56 |
| Record a Video..... | 56 |
| Change Basic Video Settings..... | 57 |
| Change Advanced Camera App Settings..... | 57 |

Chapter 6 - Configure the Computer59

| | |
|--|----|
| How to Configure the Computer..... | 59 |
| Start the Settings App..... | 59 |
| About the Structure of the Settings App..... | 59 |
| About Network Communications..... | 62 |
| Connect to a Wi-Fi Network..... | 62 |
| Connect to an Ethernet Network..... | 64 |

| | |
|--|----|
| How to Connect to Virtual Private Networks | 64 |
| About Wireless Security..... | 65 |
| About Certificates | 66 |
| Load a Certificate..... | 66 |
| About Bluetooth Communications | 67 |
| Rename the Computer..... | 69 |
| View a List of Received Files | 69 |
| About Serial and USB Communications | 69 |
| How to Share Your Mobile Data Connection | 69 |
| Share the Data Connection Through USB | 69 |
| Share the Data Connection Through Bluetooth | 70 |
| Share the Data Connection as a Portable Hotspot..... | 70 |

Chapter 7 - Manage and Maintain the Computer..... 71

| | |
|---|----|
| About File Transfers Through a USB Connection | 71 |
| How to Update the System Software | 71 |
| Update Computers Using a Device Management System | 71 |
| Upgrade the System Software | 72 |
| Reset the Computer | 72 |
| Perform a Factory Data Reset..... | 73 |
| Factory Reset: Method 1..... | 73 |
| Factory Reset: Method 2..... | 74 |
| Clean the Computer..... | 75 |

Chapter A - Specifications 77

| | |
|---|----|
| Computer Agency Information..... | 77 |
| Label Locations | 77 |
| Physical and Environmental Specifications | 78 |
| CN75/CN75e..... | 78 |
| CN75/CN75e Non-Incendive (NI)..... | 79 |
| CK75..... | 80 |
| Back Accessory Interface Pin-outs | 81 |
| Imager Specifications | 82 |

| | |
|--|----|
| Bar Code Symbologies | 82 |
| EA30 Extended Reading Range..... | 83 |
| EA30 Minimum Reading Distances..... | 84 |
| EX25 Minimum Reading Distance | 85 |
| EX25 Typical Reading Distance (1D)..... | 86 |
| EX25 Typical Reading Distance (2D)..... | 87 |
| N5603 Extended Range Reading Distances | 88 |

Customer Support

Technical Assistance

To search our knowledge base for a solution or to log in to the Technical Support portal and report a problem, go to www.hsmcontactsupport.com.

For our latest contact information, see www.honeywellaidc.com/locations.

Product Service and Repair

Honeywell International Inc. provides service for all of its products through service centers throughout the world. To find your service center, go to www.honeywellaidc.com and select Support. Contact your service center to obtain a Return Material Authorization number (RMA #) before you return the product.

To obtain warranty or non-warranty service, return your product to Honeywell (postage paid) with a copy of the dated purchase record. To learn more, go to www.honeywellaidc.com and select **Service & Repair** at the bottom of the page.

Limited Warranty

For warranty information, go to www.honeywellaidc.com and click **Get Resources > Product Warranty**.

Send Feedback

Your feedback is crucial to the continual improvement of our documentation. To provide feedback about this manual, contact the Honeywell Technical Communications department at ACSHSMTechnicalCommunications@honeywell.com.

ABOUT THE COMPUTER FEATURES

This chapter introduces the 75 Series Mobile Computers with Android® 6 operating system. Use this chapter to learn about the basic features and functions of each computer, as well as the available accessories for it.

About the 75 Series Mobile Computers

The ergonomically-designed Honeywell 75 Series Mobile Computers are built on the Android 6 operating system. They are lightweight, easy-to-use, and run most software developed for the Android 6 platform, including standalone, client-server, and browser-based applications.

The 75 Series consists of three different models: CN75, CN75e and CK75. The CN75 and CN75e computers have the same features except that the CN75e offers a larger keypad for data-input intensive applications. The CK75 has most of the same features as the CN75, but the CK75 offers a choice of imager options and does not offer WWAN or GPS radio versions. Honeywell offers heater-equipped cold storage CK75 versions to extend the use of the CK75 in cold storage and freezer environments. Non-incendive (NI) versions for hazardous environments are offered of the CN75 and CN75e.

Throughout this manual, all versions of the mobile computer are referred to as 75 Series unless information is specific to a particular model of computer. Pictures of the CN75 and CK75 represent the three models of the 75 Series computers. Non-incendive models can be identified by the device label verifying non-incendive certification and a teal colored label on the front/top of the computer.

Overview of 75 Series Features

The 75 Series includes these standard features:

| Standard Features | CK75 | CN75 | CN75e |
|--|------|------|-------|
| EA30 high-performance 2D imager | | x | x |
| Choice of EX25 or N5603ER high-performance 2D imager | x | | |

| Standard Features | CK75 | CN75 | CN75e |
|---|------|------|-------|
| 1.5 GHz dual-core, multi-engine processor with 2 GB RAM and 16 GB Flash | x | x | x |
| 802.11a/b/g/n and Bluetooth® radios | x | x | x |
| Customer-accessible microSD slot for memory cards up to 32 GB | x | x | x |

The 75 Series offers the following optional features:

| Optional Features | CK75 | CN75 | CN75e |
|---|------|------|-------|
| CDMA, UMTS Flexible Network Radio capability | | x | x |
| GPS radio on CDMA, UMTS Flexible Network Radio computers | | x | x |
| 5-megapixel auto-focus color camera with LED flash* | x* | x | x |
| Customer-accessible SIM card slot | | x | x |
| Camera feature is not available in CK75 cold storage modes. | | | |



The 75 Series Mobile Computer with an IEEE 802.11a/b/g/n radio installed is Wi-Fi® certified for interoperability with other 802.11a/b/g/n wireless LAN devices.

CN75 Front and Right Side View

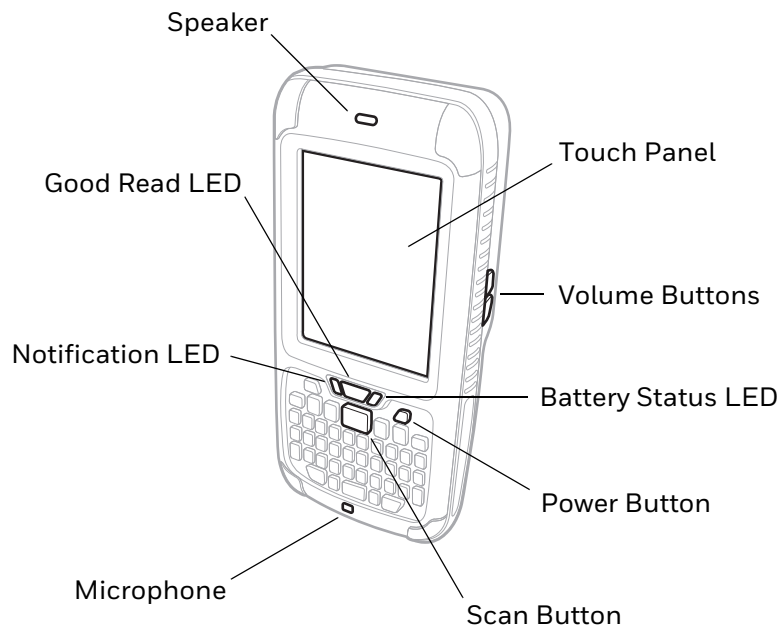

CN75 Back and Left Side View

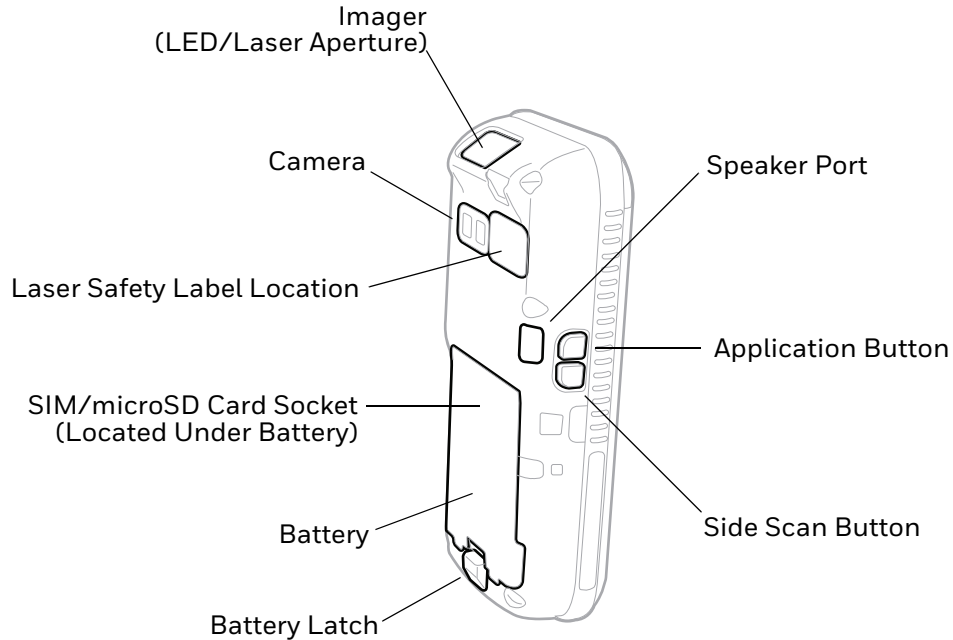

Note: Hand strap not shown.

CN75 and CN75e Non-Incendive I/O Cover

An I/O cover is supplied with non-incendive versions of the CN75 and CN75e computers. Non-incendive models can be identified by the device label verifying non-incendive certification and a teal colored label on the front/top of the computer.

To learn more, see [About the I/O Cover on Non-Incendive Models](#) on page 6.



Warning: The I/O cover must be attached when using the CN75/CN75e NI in a dangerous environment.



Avertissement : Le couvercle entrée-sortie doit être fixé lorsque le CN75/CN75e NI est utilisé dans un environnement incendiaire.

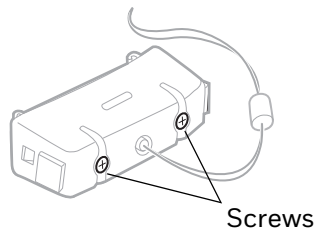

CK75 Front and Right Side View

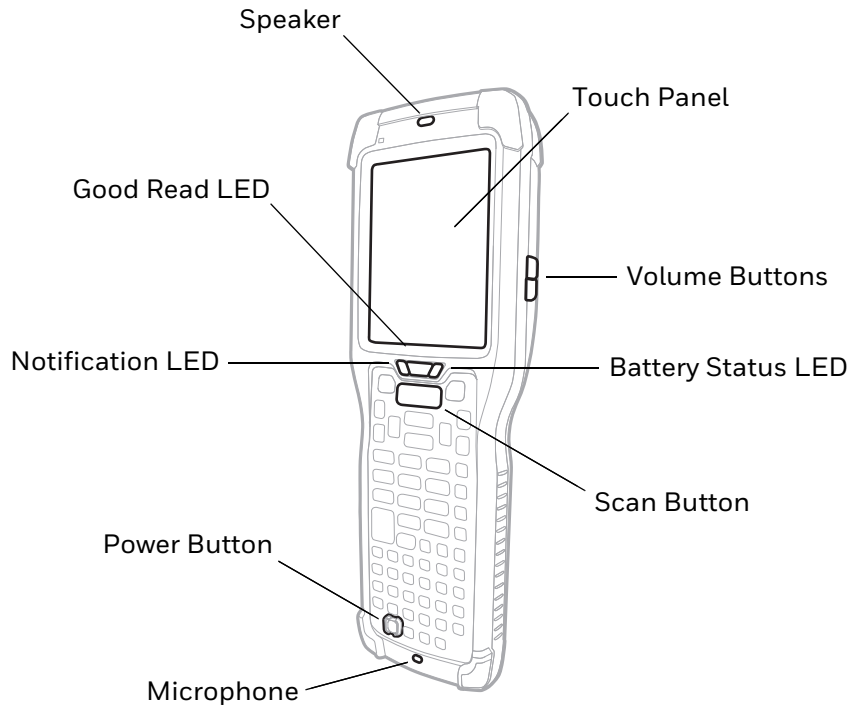

CK75 Back and Left Side View

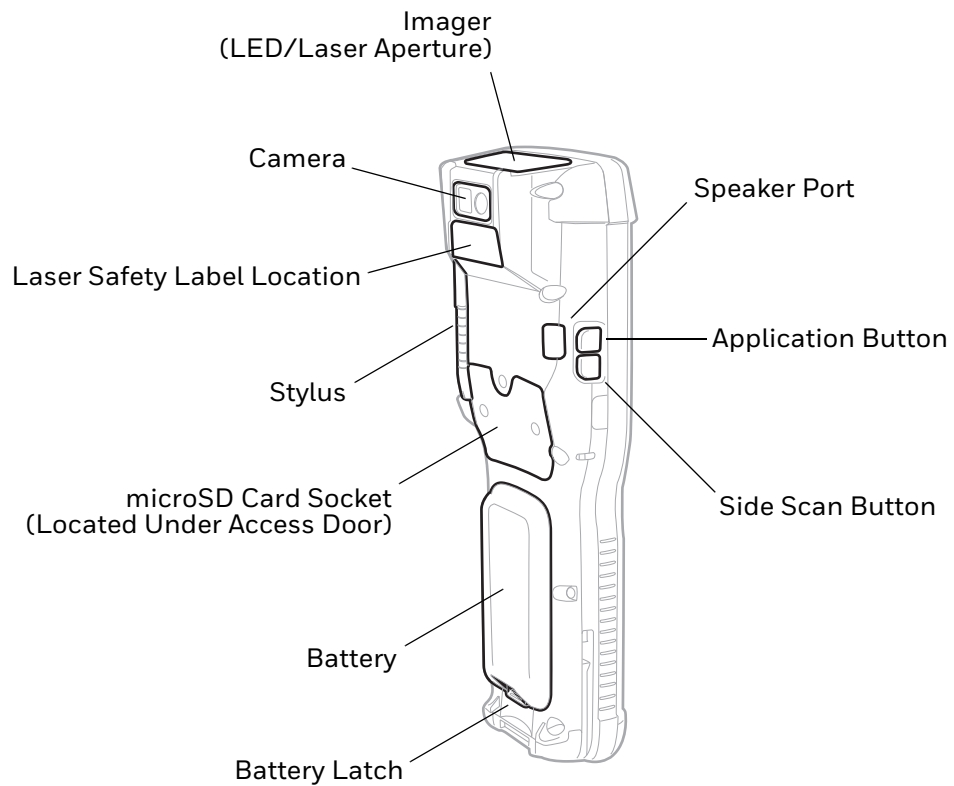

Note: Hand strap not shown.

About the Battery

The computers use the following rechargeable Lithium-ion battery packs as their main power source:

| Computer | Battery Model | Part Number | Description |
|---------------------|---------------|-------------|---------------------------|
| CN75 | 1000AB02 | 318-043-033 | 3.7 V, 4000 mAH (14.8 Wh) |
| CN75e | 1000AB02 | 318-043-033 | 3.7 V, 4000 mAH (14.8 Wh) |
| CK75 | 1001AB01 | 318-046-031 | 3.7 V, 5200 mAH (19.2 Wh) |
| CK75 (Cold Storage) | 1001AB01 | 318-046-032 | 3.7 V, 5200 mAH (19.2 Wh) |

We recommend use of Honeywell Li-ion battery packs. Use of any non-Honeywell battery may result in damage not covered by the warranty.



Caution: The battery used in this device may present a fire or chemical burn hazard if it is mistreated. Do not disassemble it, heat it above 100 °C (212 °F) or incinerate it. Dispose of used batteries promptly. Keep away from children.

About CN75 NI and CN75e NI models



Warning: Explosion Hazard - Batteries must only be changed or charged in an area known to be non-hazardous. Use ONLY Honeywell CN75 NI battery part number 1000AB02.



Avertissement : Risqué d'explosion-Les batteries doivent uniquement être remplacées ou rechargées dans un endroit non dangereux. Utilisez UNIQUEMENT Honeywell CN75 NI batterie P/N 1000AB02.

Charge the Battery

Fully charge the battery before using your computer for the first time. You can charge the battery before or after you install it in the computer. A fully discharged battery charges in approximately **6 hours**.

You can charge the **1000AB02** battery with these accessories:

- DX1 Desktop Base (Model 1002UU01) with Battery Cup Model 1002UC01 and power supply
- DX2 Dual Base (Model 1002UU02, 1002UU03) with Battery Cup Model 1002UC01 and power supply
- DX4 Quad Base (Model 1002UU04, 1002UU05) with Battery Cup Model 1002UC01 and power supply

You can charge the **1001AB01** battery with these accessories:

- DX1 Desktop Base (Model 1002UU01) with Battery Cup Model 1002UC02 and power supply
- DX2 Dual Base (Model 1002UU02, 1002UU03) with Battery Cup Model 1002UC02 and power supply
- DX4 Quad Base (Model 1002UU04, 1002UU05) with Battery Cup Model 1002UC02 and power supply

You can charge a **1000AB02** battery installed in a CN75 or CN75e with these accessories:

- DX1 Desktop Base (Model 1002UU01) with Computer Cup Model 1002UD01 and power supply
- DX2 Dual Base (Model 1002UU02, 1002UU03) with Computer Cup Model 1002UD01 and power supply
- DX4 Quad Base (Model 1002UU04, 1002UU05) with Computer Cup Model 1002UD01 and power supply
- Snap-On Adapters (Model 1000AA01, 1000AA02, 1000AA03, 1000AA04, 1000AA05, 1000AA06) and power supply
- Vehicle Power Adapter

You can charge a **1001AB01** battery installed in a CK75 with these accessories:

- DX1 Desktop Base (Model 1002UU01) with Computer Cup Model 1002UD02 and power supply
- DX2 Dual Base (Model 1002UU02, 1002UU03) with Computer Cup Model 1002UD02 and power supply
- DX4 Quad Base (Model 1002UU04, 1002UU05) with Computer Cup Model 1002UD02 and power supply
- Snap-On Adapters (Model 1000AA01, 1000AA02, 1000AA03, 1000AA04, 1000AA05, 1000AA06)

About the I/O Cover on Non-Incendive Models

An I/O cover is supplied with non-incendive versions of the CN75 and CN75e computers. Non-incendive models can be identified by the device label verifying non-incendive certification and a teal colored label on the front/top of the computer. After charging the battery, always immediately install the I/O cover.



Warning: The I/O cover must be attached when using the CN75/CN75e NI in a dangerous environment.



Avertissement : Le couvercle entrée-sortie doit être fixé lorsque le CN75/CN75e NI est utilisé dans un environnement incendiaire.

How to Replace the I/O Cover

1. Loosen the screws securing the I/O cover to the computer.

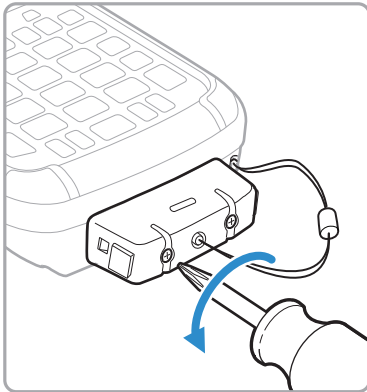

2. Press the release buttons on the sides of the cover, and then remove the cover.

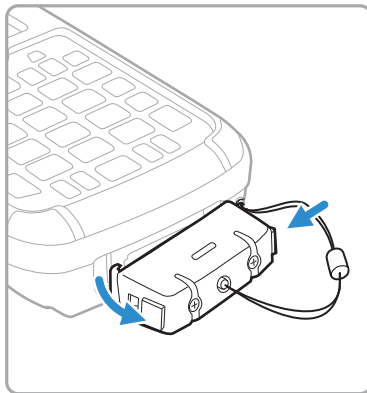

3. Detach the security tether.
4. Attach the security tether on the replacement I/O cover to the computer.
5. Snap the new cover into place.

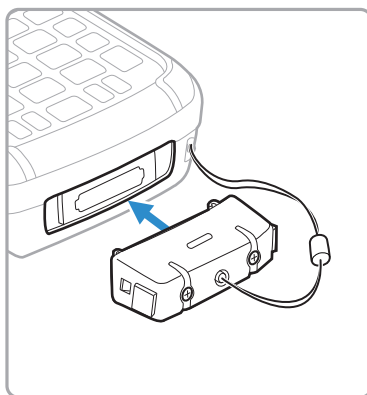

6. Tighten the screws to secure the I/O cover to the computer.

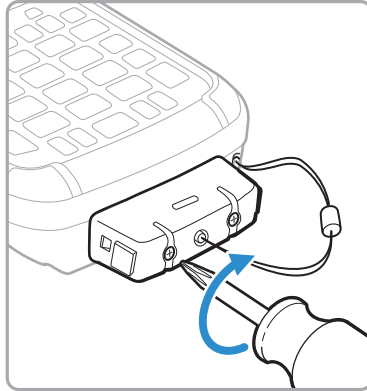

About Battery Replacement

When the battery in the computer has a low charge, replace it with a charged battery.

You should always place the computer in Battery Swap mode before removing the battery. Battery Swap mode places the computer in a low power state so that the battery can be removed for a short period of time.

Note: *When you remove a battery from the computer, Honeywell recommends that you install a charged battery within one minute to maintain your network connections.*

We recommend use of Honeywell Li-ion battery packs. Use of any non-Honeywell battery may result in damage not covered by the warranty.

Ensure all components are dry prior to placing the battery in the computer. Mating wet components may cause damage not covered by the warranty

About Battery Replacement for Non-Incedive Models



Warning: CN75 NI and CN75e NI Models

Explosion Hazard - Batteries must only be changed or charged in an area known to be non-hazardous. Use ONLY Honeywell CN75 NI battery part number 1000AB02.



Avertissement : Modèles CN75 NI and CN75e NI

Risqued'explosion-Les batteries doivent uniquement être remplacées ou rechargées dans un endroit non dangereux. Utilisez UNIQUEMENT Honeywell CN75 NI batterie P/N 1000AB02.

How to Replace the Battery

1. Save your files and close all open applications.
2. Press and hold the **Power** button, and then select **Battery Swap** from the menu.

3. Detach one end of the hand strap from the computer.

- Detach the Hand Strap From a CN75 or CN75e.

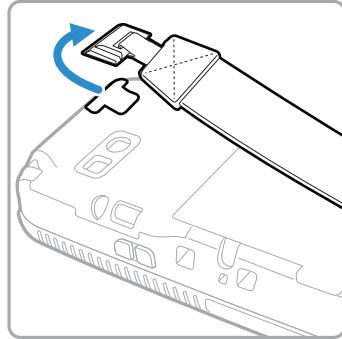

- Detach the Hand Strap From a CK75.

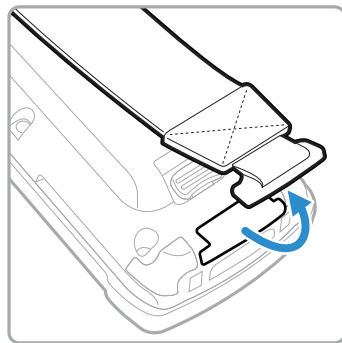

4. Remove the battery.

- On the CN75 or CN75e, push the battery latch toward the bottom of the computer until the battery releases, and then lift the battery away from the computer.

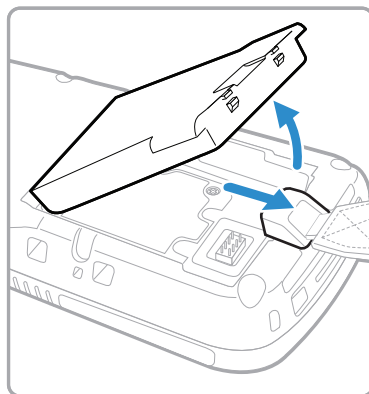

- On the CK75, push the battery latch toward the top of the computer until the battery releases, and then lift it away from the computer.

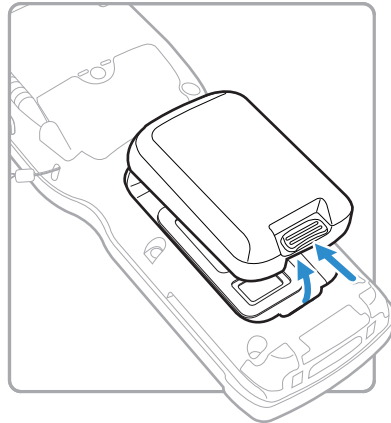





5. Insert the top end of a fully charged battery into the computer, and press down firmly on the bottom until the battery clicks into place. Make sure that the battery latch is fully engaged.
6. Attach the hand strap.
7. Press the **Power** button.

About Battery Status

Use the battery icon on the status bar to view the power status of your battery. If you want more information on your battery such as usage time or voltage, select **All apps > Settings > Battery Info** under *Honeywell settings*.

Battery Icon Status Descriptions

| Battery Icon | Status |
|---|---|
|  | Battery charge is at 100%. |
|  | Battery charge is at 50%. |
|  | Battery is low. You need to charge or replace the battery soon. |
|  | Battery is critically low. You need to replace the battery now or immediately connect the computer to a charging accessory. |
|  | Battery is charging. Computer is connected to an external power source. |

The battery status LED below the computer screen indicates the charging status of the battery.

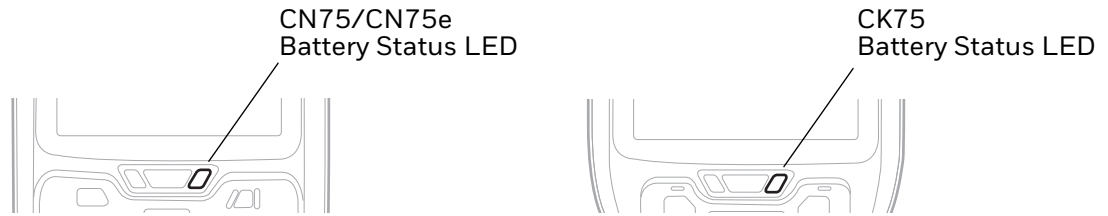

Out-of-Box Battery Status LED

The HSM Battery LED option is active as the out-of-box default.

| HSM Battery LED Status Descriptions | | |
|-------------------------------------|----------------|---------------------|
| Connected to Power | LED State | Battery Level |
| No | Blinking amber | Below 15% |
| No | Off | More than 20% |
| Yes | Steady amber | Between 0% and 60% |
| Yes | Blinking green | Between 60% and 95% |
| Yes | Steady green | Above 95% |
| Either | Blinking red | Battery error |

Set the Battery Status LED Activity

You can change the behavior of the Battery status LED if the out-of-box default behavior for a charging battery (blinking green) is not acceptable to your environment.

In addition to the out-of-box battery status LED behavior, you can choose:

- Android Default Battery LED
- No Battery LED

Use the Android Default Battery LED setting if you want the status LED to turn on steady amber and then steady green when charging. Select the No Battery LED setting if you want to use the LED as a notification LED for applications or device management solutions.

| Android Default Battery LED Status Descriptions | | |
|---|--------------|---------------------|
| Connected to Power | LED State | Battery Level |
| No | Blinking red | Below 15% |
| No | Off | 15% or more |
| Yes | Steady red | Below 15% |
| Yes | Steady amber | Between 15% and 90% |
| Yes | Steady green | 90% or more |

To modify the battery status LED setting:

1. Select **All Apps > Settings > Battery LED**.
2. Select one of these options.
 - HSM Battery LED (out-of-box default setting)
 - Android Default Battery LED
 - No Battery LED

About Battery Life and Conservation

Batteries that are stored outside the computer for long periods of time slowly discharge. Honeywell recommends storing the battery in a charger to maintain battery performance.

| When you want to: | Do this to save battery power: |
|---|--|
| Use the computer but the low battery status icon appears or the battery light comes on. | <ul style="list-style-type: none">• Connect the computer to an external power source.• Press and hold the Power button, and then select Battery Swap. After the computer turns off, remove the battery and insert a fully charged battery. |
| Stop using the computer for 5 minutes or longer. | Make sure that the low battery icon is not on the screen and the battery LED is not on. Press the Power button to place the computer in sleep mode. |
| Store the computer for more than a day. | <p>If you are storing the computer for a few days, like over the weekend, install a charged battery or connect the computer to a power source.</p> <p>If you are storing the computer for longer, remove and charge the battery, and then store both the battery and computer in a cool location. Do not place the charged battery in the computer, which runs the battery down over time even when the computer is not in use.</p> <p>If you store the battery for several months, recharge the battery to keep it at peak performance.</p> |
| Store the battery outside the computer. | Store the battery in a charger. |

Enable Airplane Mode

If you do not need to connect to any wireless networks, you can enable Airplane mode to turn off all the radios and save battery power.

There are three ways to enable or disable Airplane mode:

- Press and hold the **Power** button until the menu appears, and then select **Airplane mode** to toggle the mode on or off.
- In the Settings app, tap **More**, and then select **Airplane mode** to enable the mode. If Airplane mode is already enabled, tap it to disable the mode.

- On the home screen, swipe down from the status/notification bar. Tap  on the status bar, and then tap **Airplane mode** to enable the mode. If Airplane mode is already enabled, tap it to disable the mode.

About the Status LEDs

The status LEDs turn on, turn off, or blink to indicate a specific activity on your computer. All six status LEDs are not available on every 75 Series computer. For example, the QWERTY versions of the CN75 and CN75e do not have a Green key status LED.

Location of the CN75 Status LEDs

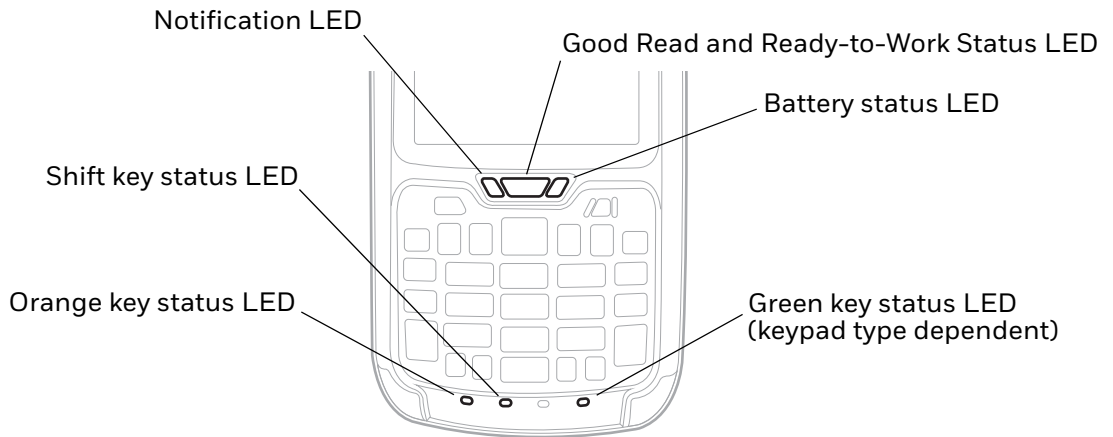

Location of the CK75 Status LEDs

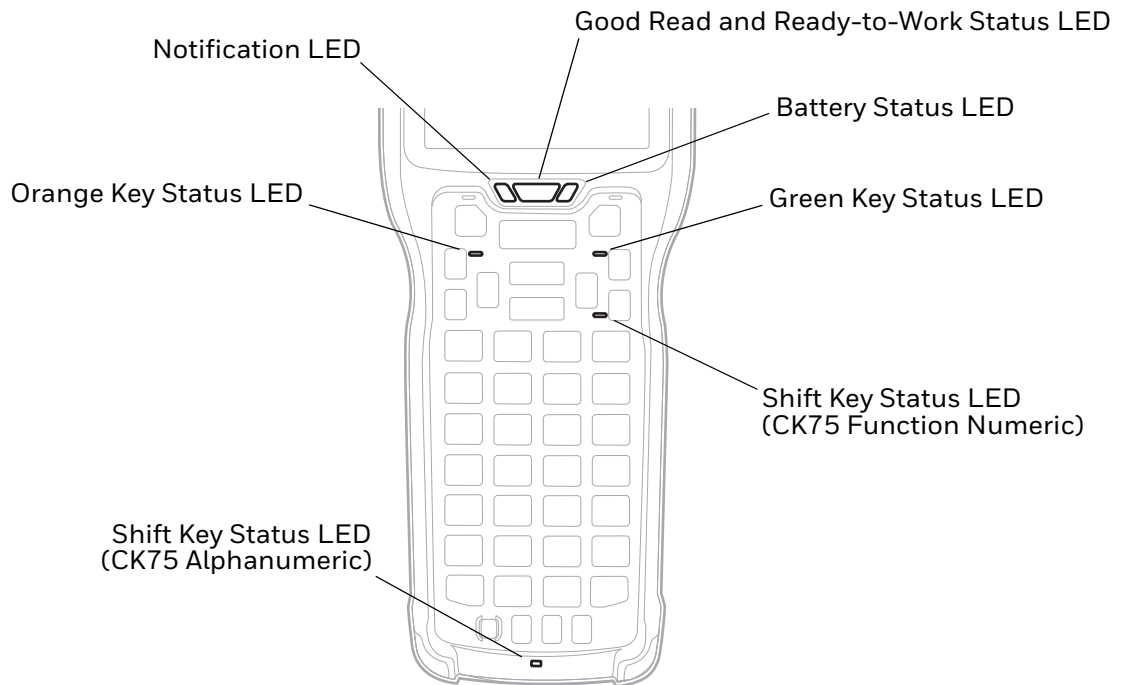

Status LED Descriptions

| LED | Color | Description |
|----------------|---------------|---|
| Notification | Amber | This LED is user-programmable. |
| Good Read | Green | The computer successfully decoded a bar code. |
| Ready-to-Work | Blue | If you have Honeywell Enterprise Terminal Emulator (TE), the application is running and connected to the host. If you do not have Enterprise TE, you can configure the Ready-to-Work indicator to turn on or off to indicate a healthy state. |
| | Blinking blue | Enterprise TE is running but not connected to the host. The computer is unhealthy. |
| | Off | Enterprise TE is not installed or not running. The computer is healthy. |
| Battery Status | | See About Battery Status on page 10. |
| Key Status | Green | The Green function key is enabled. |
| | Orange | The Orange function key is enabled. |
| Shift | Red | The Shift key is enabled. |

About the Keypad

The 75 Series is available in these keypad configurations:

- The QWERTY keypad is available for both the CN75 and CN75e but the CN75e also includes a larger keypad with numeric keys (phone-style with 1-2-3 digits across the top). The QWERTY keypad is designed for applications that require primarily alphabetic data. This keypad also lets you enter special characters by pressing color-coded key sequences.
- The numeric keypad is available for both the CN75 and CN75e but the CN75e also includes a larger keypad with a row of function keys. The numeric keypad is for applications that require mainly numeric data. This keypad also lets you enter special characters, including the alphabet, by pressing color-coded key sequences.
- The full numeric and function keypad is available for the CK75. The calculator-style (7-8-9 digits across the top) numeric key layout with additional function keys (F1-F12) is designed for applications that require mainly numeric data. This keypad also lets you enter special characters, including the alphabet, by pressing color-coded key sequences.
- The alphanumeric keypad is available for the CK75. The alphanumeric keypad is designed for a wider range of applications that require both numeric and alphabetic data. The layout includes calculator-style (7-8-9 digits across the top) numeric keys, alphabetical keys, and function keys. This keypad also lets you enter special characters and alternate functions by pressing color-coded key sequences.

CN75 QWERTY Keypad / CN75 Numeric Keypad



CN75e QWERTY Numeric Keypad / CN75e Numeric Keypad



CK75 Alphanumeric Keypad /CK75 Numeric Function Keypad





About the Keypad Backlight

Press the  key to turn the keypad backlight on for approximately 5 seconds.

About the Color-Coded Keys

Note: The QWERTY keypads on the CN75 and CN75e do not include a green key.

Use the orange  key and the green  key to access additional characters, symbols, and functions printed on the keypad overlay. After you understand how to use the color-coded keys and key sequences, you can access all of the additional features printed on the keypad overlay.

Press the Green or Orange key twice to lock it. When the key is locked, the LED turns on. Press the key once to unlock it.

Enter Characters on the QWERTY Keypad

You need to use the orange modifier key  and the shift key  to access all characters and functions on the QWERTY keypad.



To type a character:

- Press the key for that character.

To type a character or access a function on the overlay:

- Press  and then press the key for the character or function.



To only type characters or access functions on the overlay:

- Press   to lock the orange modifier key to stay on, and then press the keys for the characters or functions.

To type a single uppercase letter:

- Press  and then the letter key.



To type all uppercase letters:

- Press   to turn on Caps Lock, and then press the letter keys.



You can still type orange modifier characters by pressing  and then the key for that character.

To turn off Caps Lock, press .

Enter Characters on the Numeric Keypad

You need to use the orange modifier key  and the green modifier key  to access all characters and functions on the Numeric keypad.











To type a character or access a function printed in orange or green on the overlay:

- Press  or , and then press the key for the character or function.

To type letters in the upper right corner of a key:



- Press  and then press the key one to three times depending on the position of the letter.

For example, in the upper right corner of the  key there are the letters “ABC”:

- To type “c”, press    .
- To type “C,” press   and then press    .



Note: On the calculator-style keypad, the  is replaced by the .

To only type letters:



- Press   to lock the green modifier key, and then press the key one to four times depending on the position of the letter.

While the green modifier key is locked, press  to toggle between only uppercase and lowercase letters.

To unlock the green modifier key, press .

Note: *If uppercase letters are enabled and you unlock the green modifier key, you may need to press   to type lowercase letters.*

Enter Characters on the CK75 Keypads

You need to use the orange modifier key , the green modifier key , and the Shift or Caps Lock key  to access all characters and functions on the Alpha, Alphanumeric, and Numeric Function keypads.

To type a character or access a function printed in orange on the overlay or in the upper left corner of a key:

- Press  and then press the key for the character or function.

To type a character or access a function printed in green on the overlay:



- Press  and then press the key for the character or function.

To type a single uppercase letter:

- Press  and then the letter key.

To type all uppercase letters:

- Press   to turn on Caps Lock, and then press the letter keys.

You can still type orange or green modifier characters by pressing  or  and then the key for that character.

To turn off Caps Lock, press .

About the Power Button

Press the Power button to turn the computer on.

Once the computer is turned on, a quick press of the **Power** button toggles the computer in or out of Sleep mode. Sleep mode turns the touch panel off and initiates the screen lock. The phone can still receive incoming calls on WWAN equipped models.

Note: *By default, the computer enters Sleep mode automatically after the computer is inactive for a programmed period of time. To learn more about the feature, see [Configure Sleep Mode](#) on page 20.*

To select a power mode, press and hold the Power button, and select a power mode from the list that appears:

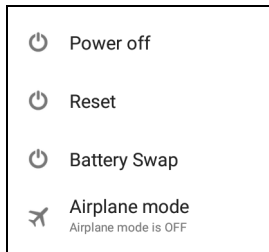

Use the following table to understand the menu options:

| Power Menu Option | Description |
|-------------------|--|
| Power off | Turns the computer off, including the phone. The computer will not receive incoming calls. |
| Reset | Performs a system reboot. The computer does not save the current system state, but the registry and file systems are saved. Data in open apps may be lost if not saved before the reset. The computer shuts down all running processes and restarts. |
| Battery Swap | Places the computer in a low power state and saves your settings while you install a charged battery. When you press the Power button after installing the charged battery, the computer resumes where you left off prior to entering Battery Swap mode. Use this setting only for swapping the battery. If you installing a SIM or microSD card, Power off the computer. |
| Airplane mode | Turns Airplane Mode on or off. When Airplane mode is on, the wireless radios are disabled and do not transmit or receive. |

About the Screen Backlight and Sleep Mode



The display has an ambient light sensor that automatically adjusts the backlight intensity to conserve power and ensure the display is readable. You can set the backlight intensity levels as needed for your environment.

To save power, the computer enters Sleep mode automatically if left inactive. Sleep mode turns off the screen and activates the screen lock. You can change the time limit before Sleep mode activates.

Note: *By default, the computer enters Sleep mode automatically after the computer is inactive for a programmed period of time. To modify the timeout limit, select All Apps > Settings > Display > Sleep.*

Configure the Screen Brightness

You can configure the screen brightness in the Settings app.

1. Tap **All Apps > Settings > Display**.
2. Modify one of the following:
 - To have the computer automatically adjust the brightness for your work environment, tap the **Adaptive brightness** setting. Tap **Adaptive brightness** to toggle the setting on  or off .
 - To set the brightness level manually, verify the **Adaptive brightness** setting is turned off , and then tap **Brightness level**. Adjust the slider to set the brightness level.

Configure Sleep Mode

By default, the computer enters Sleep mode automatically after the computer is inactive for a programmed period of time. To modify the timeout limit:

1. Tap **All Apps > Settings > Display**.
2. Tap **Sleep**.
3. Select the amount of inactive time (minutes) before Sleep mode activates.

About the CK75 Cold Storage Model Heater

CK75 Cold Storage (CS) models come equipped with touch screen and scan window heaters to support extended use in freezers as well as transitions into and out of freezer areas.

CK75 cold storage models have external temperature monitoring enabled by default to determine when the computer enters a cold storage environment. Once the ambient temperature drops below the **Heater enable temperature**, the system starts a **Chill timer**.

Once the **Chill timer** expires, the system operates in one of two configurable modes:

- Automatic mode for maximizing battery life in cold storage environments and average window defrost times. Manual mode is disabled.

- Preemptive mode (pre-heat) for minimizing window defrost times with average battery life in cold storage environments. **Manual** mode is enabled.

How Automatic Mode Works

Automatic mode maximizes the cold storage battery life by only turning the heater on once the following conditions are met in the order listed:

1. The computer detects the ambient temperature has lowered below the set **Heater enable temperature**.
2. The **Chill timer** expires. A snowflake ❄️ icon appears in the status bar.
3. The computer detects a quick rise in the ambient temperature indicating an exit from cold storage.

If you remove the computer from cold storage before the **Chill timer** expires, the system does not turn on the heater, saving battery power.

Note: When the heaters turn on in Automatic Mode, the icon changes from a snowflake ❄️ to a heater 🔥.

In Automatic mode, cold storage battery life may exceed 6 hours (scanning a bar code every ten seconds). Window defrost times should be a minute or less with factory default settings implemented.

You can configure the heater operation for your individual environment from the **Heater** option in the **Settings** app or by editing the **Heater** key values in the DeviceConfig.xml file. To learn more, see [Configure the Heater Feature](#) on page 22.

How Preemptive Mode Works

Preemptive mode minimizes screen defrosting time but slightly reduces cold storage battery life since the heaters enter a low power pre-heat stage before the computer detects a rise in the ambient temperature.

The heater only enters the low power pre-heat stage once the following conditions are met in the order listed:

1. The computer detects the ambient temperature has lowered below the set **Heater enable temperature**.
2. The **Chill timer** expires. A snowflake ❄️ icon appears in the status bar.
3. The heater **Power on time delay** timer expires.



Note: Once the computer enters the pre-heat stage, the icon changes from a snowflake ❄️ to a heater 🔥.

Pre-heating keeps the windows warm to minimize condensation and frost when the computer is removed from cold storage allowing for quicker defrost times. The heaters switch to full power to defrost the windows when the computer detects a quick rise in the ambient temperature.

In Preemptive mode, the cold storage battery life ranges from a maximum of 6 hours to a minimum of 1.5 hours depending on the heater **Power on time** set. The window defrost times range from zero to a maximum of one minute with factory default settings.

You can configure the heater operation for your individual environment from the **Heater** option in the **Settings** app or by editing the **Heater** key values in the DeviceConfig.xml file. To learn more, see [Configure the Heater Feature](#) on page 22.

How to Manually Turn the Heaters On/Off

If you want to manually turn the heaters on or off while in cold storage, tap the snowflake  or heater icon  in the status bar.

If the **Manual** mode (Preemptive mode) setting is enabled, the heater **Power on time** delay timer is not stopped if the icons are used to turn the heater on or off. The timer continues to run and the heaters still turn on when the timer expires.

If the **Manual** mode (Preemptive mode) setting is disabled, the heater **Power on time** delay timer is not used and pre-heating does not automatically start, but the snowflake icon  can still be tapped to turn on the heaters for pre-heating.

Configure the Heater Feature

You can configure the following parameters in the **Settings** app or the DeviceConfig.xml file to optimize the **Heater** feature to fit your specific application environment.

To learn more about how to configure the heater using the **Settings** app or by modifying the DeviceConfig.xml file with **EZConfig**, see [page 24](#).

| Settings App: Heater Setting | DeviceConfig.xml: Heater Key | Description |
|---|---|---|
| Heater | Enable | Enable or Disable the heater feature and temperature monitoring. Tap the switch button at the top of the screen to toggle the feature on or off. The default is ON. |
| Turn heater on when the temperature has changed by: | DeltaT | Set the sensitivity of the cold storage exit trigger. To detect a cold storage exit, the computer looks for a quick rise in temperature (°C), defined by this setting, over a brief period of time. The default is 0.5°C. |

| Settings App: Heater Setting | DeviceConfig.xml: Heater Key | Description |
|---------------------------------|---------------------------------|---|
| Duration: Heater | DurationHeater | Set the length of time (minutes) the heaters stay on at full power (100%) once the computer detects a quick rise in temperature, defined by the DeltaT value (the Turn heater on when the temperature has changed by "x" value). The default value is 5 minutes. <i>Note: The heaters may turn off before the timer has expired if a temperature reading indicates the computer is warm enough or you manually turn off the heaters by tapping the heater icon once.</i> |
| Low battery threshold | LowBatteryThreshold | Set a low charge battery threshold (%) that triggers the computer to turn off the heaters to conserve battery power. The default value is 25%. |
| Heater enabled temperature | EnableT | Set the temperature (°C) that the computer must fall to before the heaters turn on. The Heater enabled temperature is used to identify cold storage entry. Once this temperature is detected, the Chill timer starts. |
| Chill time | ChillTime | Set the time limit (minutes) for how long the computer must remain at or below the defined Heater enable temperature before: <ul style="list-style-type: none"> the heaters turn on if in Automatic mode, or the timer for the heater Power on time delay starts when Preemptive mode (Manual mode) is enabled. <i>Note: If you remove the computer from cold storage before the timer expires, the system does not turn on the heaters, saving battery power.</i> |
| Update | | Tap to apply changes made to settings. |
| Default | | Tap to set the Heater settings back to their default values. |
| Manual/Automatic | DriverMode | Tap the button to switch between Automatic mode or Manual (preemptive) mode. When Manual mode (preemptive mode) is enabled: <ul style="list-style-type: none"> You can use the heater Power on time setting to configure when the computer pre-heats the windows in cold storage environments. The Heater on/off button next to the Manual/Automatic button is active. You can tap the button to toggle the heater on or off. |

| Settings App: Heater Setting | DeviceConfig.xml: Heater Key | Description |
|--|---------------------------------|--|
| Heater Cycle Time Duration | | When the heaters are activated, the computer cycles power between the scanner window heater and the display window heater. You can independently adjust the cycle time for each heater. <i>Note: During pre-heating, there is a small buffer time between heater cycles when both heaters are turned off. The length of the buffer is not configurable.</i> |
| Duration: Scanner heater (seconds) | DurationScanner | Set the length of time (seconds) that the scanner heater is cycled on. |
| Duration: LCD heater | DurationLCD | Set the length of time (seconds) that the screen heater is cycled on. |
| Fast monitoring interval | FastInterval | Set sampling interval time (seconds) used once the computer detected cold storage entry (defined by the Heater enabled temperature). |
| Slow monitoring interval | SlowInterval | Set sampling interval time (seconds) used once the computer detects cold storage exit (defined by DeltaT). |
| Sample Window | SampleTimes | Set how many temperature samples are used to calculate a true DeltaT event (cold storage exit). |
| Power on time | PowerOnTime | Set the length of time (minutes) that the computer waits after the Chill timer has expired before activating the low power pre-heat window feature. |
| Disable temperature | DisableT | Set the temperature limit (°C) that triggers turning off the heater. |
| Blanking | | Toggles turning the heater on or off during scanning. |

Configure the Heater in the Settings App

1. Tap **All apps > Settings**.
2. Tap **Heater** under Honeywell settings.
3. Modify the heater parameters.
4. Tap **Update** to apply the changes.
5. Tap **OK**.

Configure the Heater in the EZConfig

You can also configure the heater by modifying key values in EZConfig.

1. Tap **All apps > Settings > Power Tools > EZConfig**.
2. Tap **Menu ≡ > Generator**.

3. Select the **DeviceConfig.xml** file.
4. Drill down to **Honeywell Settings > Heater**. You can expand sections by selecting the plus sign next to the section name.
5. Modify the heater parameters.
 - a. Tap a **Key** in the **Heater** section.

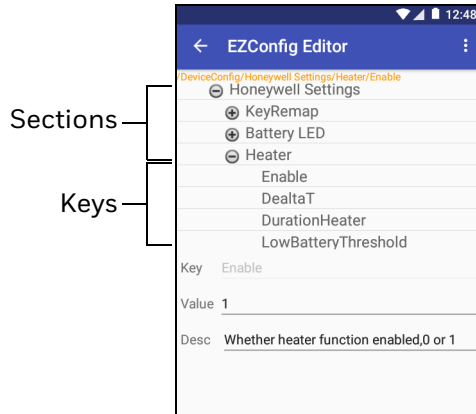

- b. Tap and edit the **Value** field for the Key.
6. Tap **⋮**, and then select **Save**.
7. Tap **⋮** again, and then select **Update Configure**.
8. If prompted, **Reboot** the computer.

About Audio Features

Your mobile computer has a speaker, a microphone, and several software tools to configure sound volume or enable vibration feedback.

Adjust the Speaker Volume

Use the volume buttons on the right side of the computer to adjust the volume of ringtones, media, notifications or alarms.



1. Press either the **Volume Up** or **Volume Down** button. The volume slider appears.

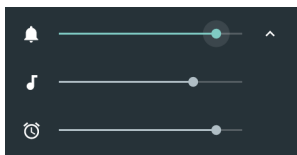

2. Tap the down arrow **∨** to expand the options.



3. Use the stylus or the **Volume** buttons to adjust each volume type.

- Use the  slider for notifications and rings.
- Use the  slider for media (e.g., music, videos and other media).
- Use the  slider for alarms.

Enable Vibrate Mode

You can use the Volume down button to quickly enable Vibrate mode so the computer vibrates instead of emitting sound for notifications and rings. If you still want to hear alarms, turn on the Alarms only feature.



1. Press the **Volume Down** button until the computer vibrates.

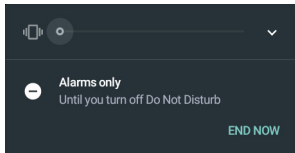

2. To turn on the Alarms only feature, press the **Volume Down** button again with the volume slider open.



The status bar at the top of the screen indicates the active mode:

- When vibrate mode is active,  appears.
- When Alarms only mode is active, the Do Not Disturb icon  appears.

Configure Audio Settings

This section describes additional audio and sound settings you can configure in the Settings app.

- To change audio settings, start the **Settings** app and tap **Sound & notifications**.

| Setting | Description |
|-------------------------------|--|
| Volume | Use the sliders to adjust the volume level for media (music, videos and other media), alarms and rings (notifications and ringtones). |
| Also vibrate for calls | Enable or disable vibration when the phone rings. |
| Do not disturb | <ul style="list-style-type: none"> • Set what kinds of alarms, notifications, events, or selected callers are allowed to interrupt Do not disturb mode. • Set rules for automatically turning Do not disturb mode on or off (e.g., weekend, weeknight, or during calendar events). |
| Phone ringtone | Select a ringtone. |
| Default notification ringtone | Select a notification sound. |

| Setting | Description |
|-----------------------|--|
| Other sounds | |
| Dial pad tones | Enable or disable audio tones when you use the phone keypad. |
| Screen locking sounds | Enable or disable an audio tone when the screen is locked. |
| Charging sounds | Enable or disable an audio tone when the computer is charging. |
| Touch sounds | Enable or disable audio sounds when you use the touch screen. |
| Vibrate on touch | Enable or disable vibrate mode when you touch the screen. |

Insert a MicroSD Card

You can use a micro Secure Digital (SD) card to increase file storage capacity or to install software. The 75 Series mobile computers support an optional microSD™ card (up to 32 GB maximum capacity).

Note: Always power off the computer and remove the battery before attempting to install or remove a card.

Install a MicroSD Card in a CN75 or CN75e

You need a Phillips screwdriver to install the microSD card. Format the microSD card before initial use.

1. Press and hold the **Power** button, and then select **Power off**.
2. Release the handstrap and remove the battery (see page 8).
3. Remove the two screws and open the card access door.

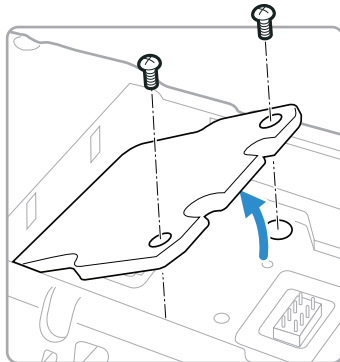

4. Slide the SIM card holder to the left and up to reveal the microSD card holder.

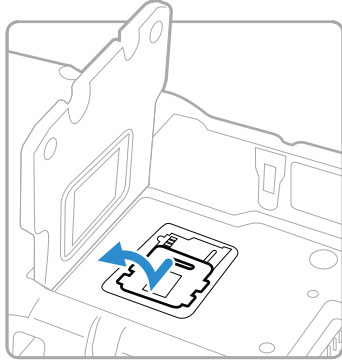

5. Slide the microSD card holder towards the top of the computer, and then lift up to reveal the microSD card socket.

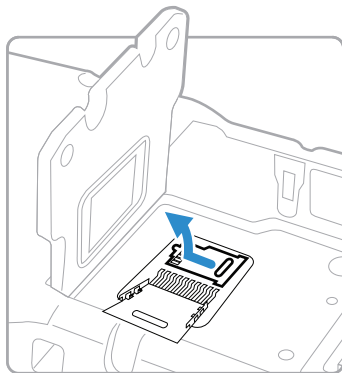

6. Place the microSD card in the holder with the contacts facing away from the holder.

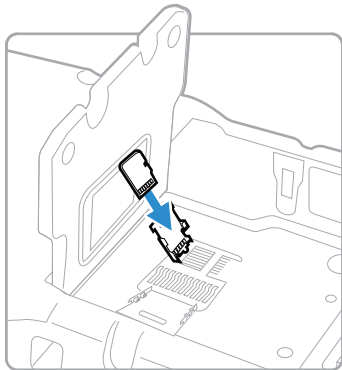

7. Close and latch the microSD card holder and SIM card holder.

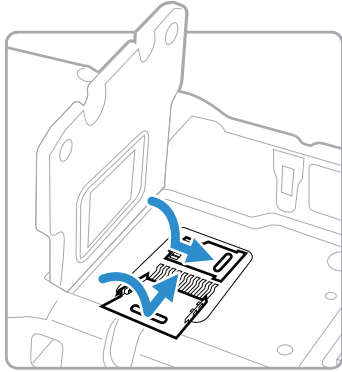

8. Close the card access door and install the two screws.
9. Install the battery. Press down firmly on the bottom of the battery, and make sure that the battery release tab is fully engaged.
10. Attach the handstrap.
11. Press the **Power** button. Once the computer finishes the power up sequence and identifies the new card, a set up query appears.
12. Select how you want the microSD card used: **Use as portable storage** or **Use as internal storage**.
13. Tap **Next** and then **Done** once the SD card is ready message appears.

Install a microSD Card in a CK75

You need a slotted screwdriver to install the microSD card. Format the microSD card before initial use.

1. Press and hold the Power button, and then select **Power off**.
2. Remove both ends of the handstrap.

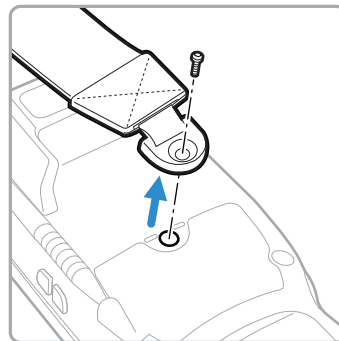
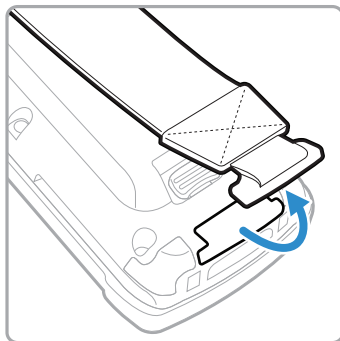

3. Remove the battery (see page [9](#)).

4. Remove the two screws that attach the card access door to the back of the computer.

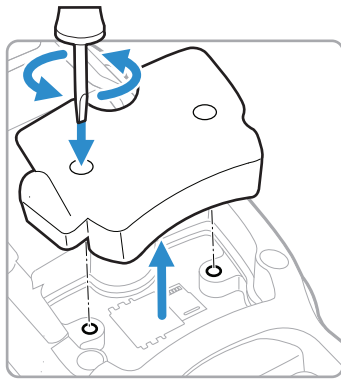

5. Slide the SIM card holder to the left and up to reveal the microSD card holder.

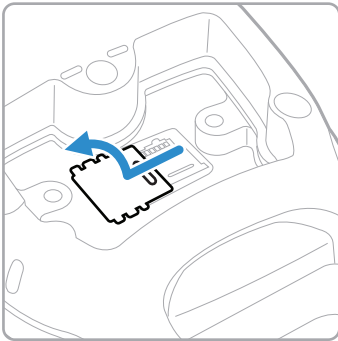

6. Slide the microSD card holder towards the top of the computer, and then up to reveal the microSD card socket.

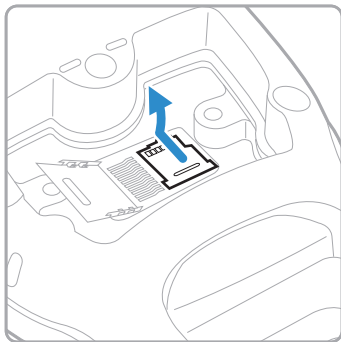

7. Place the microSD card in the holder with the contacts facing away from the holder.

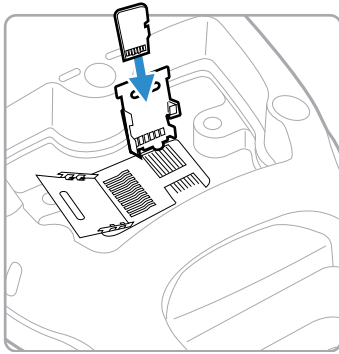

8. Close and latch the microSD card holder and SIM card holder.

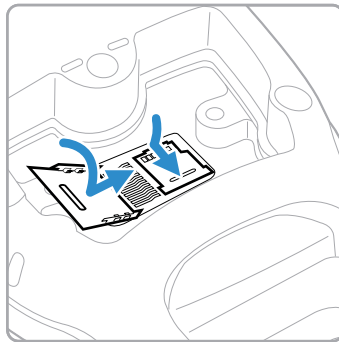

9. Replace the door and secure it with the two screws removed in Step 4.
10. Install the battery. Press down firmly on the bottom of the battery, and make sure that the battery release latch is fully engaged.
11. Attach the handstrap.
12. Press the **Power** button. Once the computer finishes the power up sequence and identifies the new card, a set up query appears.
13. Select how you want the microSD card used: **Use as portable storage** or **Use as internal storage**.
14. Tap **Next** and then **Done** once the SD card is ready message appears.

How to Transfer Files

To transfer files you need to physically connect the mobile computer to your desktop PC through a USB connection. When the computer is connected through USB and configured for file or photo transfer, you can browse to it and drag-and-drop to move files back and forth to a Windows® PC. If you are transferring files to and from a Mac, use the Android File Transfer application (available from www.android.com/filetransfer).

Note: File transfer through a USB connection is disabled by default. You need to configure the USB connection for transferring files or photos. USB tethering must be turned off before you can transfer files through USB.

You can use these accessories to connect your mobile computer to your PC:

- USB snap-on adapter with power supply and USB cable
- Desktop Base with battery cup, power supply and USB cable

Note: To learn more about accessories available for 75 Series computers, go to www.honeywellaidc.com or contact your local Honeywell sales representative.

Configure USB Connection and Transfer Files

1. Connect the mobile computer to your PC using a USB charge/communication accessory.
2. By default, the mobile computer is in **USB charging only** mode. To enable file transfers, swipe down from the notification/status bar.
3. Swipe down from the notification/status bar at the top of the screen.
4. Tap the **USB for Charging** notification.

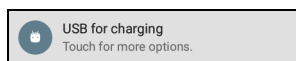

5. Select **Transfer files (MTP)** or **Transfer photos (PTP)**.

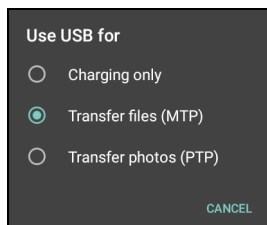

6. Open a file browser on you PC and navigate to the 75 Series computer. You can now copy, delete, paste and/or move files or folders between the two computers and any SD card installed.

70 Series Accessories

The mobile computer ships with a battery, a stylus and hand strap. Non-Incendive models also ship with an I/O cover. All other accessories are sold and ordered separately. For help, contact your local Honeywell sales representative.

Note: All 75 Series mobile computers are compatible with 70 Series accessories.

| Accessory | Description |
|--|--|
| Audio Snap-On Adapter | Use the audio adapter to connect the computer to a headset. |
| Back Accessory Interface | Use the back accessory interface to attach accessories such as the magstripe reader adapter to the CK75. |
| Battery Model 1001AB01 | This battery provides main power to the CK75. <ul style="list-style-type: none"> Standard Rechargeable Li-ion battery (Model 1001AB01/PN 318-046-031) Cold Storage Rechargeable Li-ion battery (Model 1001AB01/PN 318-046-032) |
| Battery Model 1000AB02 | This battery provides main power to the CN75 and CN75e. Standard Rechargeable Li-ion battery (Model 1000AB02/PN 318-043-033). |
| Desktop Stand | Use the desktop stand to hold the 75 Series computer on your desk or a stable surface. |
| DEX/UCS Snap-On Adapter | Use this adapter to receive and send serial communications through a DEX/UCS connection. |
| DX1 Desktop Dock with USB connectivity | Use the desktop dock with the: <ul style="list-style-type: none"> Computer cup to charge the battery while it is installed in the computer. Battery cup to charge the battery. |
| DX2 Dual Dock and DX4 Quad Dock. The DX2 and DX4 are available in charge-only and Ethernet configurations. | Use these charger bases with the: <ul style="list-style-type: none"> Computer cup to charge batteries while they are installed in the computer. Battery cup to charge two batteries. |
| Ethernet Snap-On Adapter | Use the Ethernet adapter to be able to connect the computer to an Ethernet network. |
| Handstrap Replacement Kit | You can order and install a replacement handstrap for the CN75, CN75e, and CK75. Each kit contains 5 handstraps. |
| Holster | Use the holster to store the computer when you need your hands free. |
| RS-232 Snap-On Adapter | Use the RS-232 adapter to convert the connector on the bottom of the computer to a serial connector. |
| Scan Handle | Use the scan handle to provide better ergonomics to the computer for high-volume scanning applications. |
| Tethered Stylus Replacement Kit | You can order and install a replacement stylus. |
| USB Snap-On Adapter | Use this adapter to convert the bottom connector of the computer to a USB connector. |

| Accessory | Description |
|----------------------------|---|
| Vehicle Dock | Use the vehicle dock to provide power and hold your computer while you are using it in a vehicle. |
| Vehicle Holder | Use the vehicle holder to hold your computer while you are using it in a vehicle. |
| Vehicle Power Adapter | Use the vehicle power cable adapter to provide power to the computer from your vehicle. |
| Vocollect® Snap-On Adapter | Use this adapter to be able to use the Vocollect voice solution in your warehouse. |

ABOUT THE USER INTERFACE AND APPLICATIONS

Learn about the Android user interface and how to interact with the screen. You can also use this chapter to learn about the Honeywell applications on your computer, as well as additional applications available for download from www.honeywellaidc.com.

About the User Interface

The Android 6.0 operating system provides a touch-friendly and easy to navigate user interface.



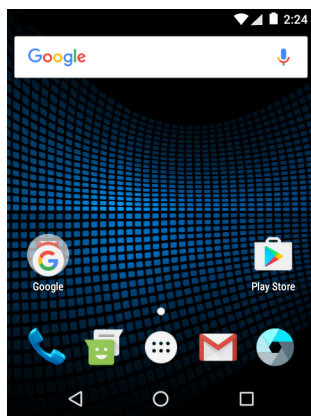

About the Home Screen

When you turn on your mobile computer, the Home screen is the first screen that appears after language provisioning is complete.



- Notification/Status Bar
- Search Bar
Touch  to initiate a voice search or command.
- Home Screen Panels
- Favorites Tray and All Apps Icon
- Navigation Buttons

| Screen Feature | Description |
|-------------------------|--|
| Notification/Status Bar | Use the notification/status bar icons to quickly view current status and system information. Status icons to the left tell you when and app has sent a notifications, such as a new message or meeting notice. System icons to the right and provide information such as network signal strength and battery power status. |

| Screen Feature | Description |
|--|--|
| Favorites tray | App icons in the tray are visible on every Home screen. |
| All Apps Icon  | Select the All Apps icon to access all the apps available on the computer. The All Apps icon is always in the center of the Favorites tray. |
| Navigation buttons | |
| Back | Tap  to return to the previous screen, even if that screen was in a different app. |
| Home | Tap  to return to the Home screen. If there are multiple Home screens, tap to return to the center Home screen. |
| Recent Apps | Tap  to view and switch between recently opened apps. |

Customize the Home Screen

You can add application icons to any Home screen for easier access.

1. Tap  to open the All Apps screen.
2. Tap and hold the app you want to add. The computer vibrates, and then switches to a smaller view of the Home screen panels.
3. Drag and drop the app icon into place.
 - If you want to add another home screen, drag the icon to the right edge of the screen before releasing the icon.
 - If you want to create a folder, drag and drop the icon on top of another icon.

To add a Widget:

1. Tap and hold an empty section of the Home screen.
2. Tap **Widgets**.
3. Tap and hold the Widget you want to add.
4. Drag and drop the Widget into place on the Home screen.

Customize the Favorites Tray

Modify the Favorites tray to contain the apps you use the most.

1. Tap and hold the app icon you want to replace on the Favorites tray.
2. Drag and drop the app to the word “**Remove**” at the top of the screen.
3. Tap **All Apps**.
4. Tap and hold the icon for the app you want to add.
5. Drag and drop the icon into position on the Favorites tray.

View and Manage Notifications

When notification icons appear at the top of the screen, swipe down from the status bar.

- Tap a notification to view more details in the relevant app or to change available settings.
- Swipe left or right on a single notification to dismiss only that notification.
- Select  to dismiss all the notifications listed.

To close the notification drawer, swipe up from the bottom of the screen, or tap Back or Home.

Open Quick Settings





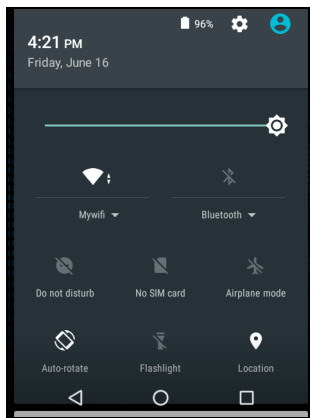

Use the **Quick Settings** screen to access common settings. Tap an icon to toggle the feature on/off or open additional settings.

To open Quick Settings, swipe down twice from the status bar at the top of the screen. To close Quick Settings, tap the top of the screen, Back or Home.



Notification and Status Icons

Icons in the Notification/Status bar at the top of the screen immediately show you the status of your network, your phone, the volume, the battery, and the time. Use the following table to understand what the icons mean.

| Icon | Description | Icon | Description |
|--|--|---|---------------------------|
| <i>Note: Notification and status icons are hardware and software dependent. Some of the icons listed below may not be relevant for your Dolphin model.</i> | | | |
|  | Pending calendar event |  | Sound is turned off |
|  | Pending alarm and Alarm is set |  | Vibrate mode is turned on |
|  | New text message or multimedia message |  | Battery charge is at 100% |

| Icon | Description | Icon | Description |
|------|---|------|--|
| | Error with text or multimedia message delivery | | Terminal is connected to external power and the battery is charging. |
| | New Gmail™ message | | Terminal is connected to external power and the battery is fully charging. |
| | New E-mail | | Airplane mode is turned on |
| | ADB active (USB debugging enabled) | | Bluetooth incoming file notification |
| | Uploading data | | Bluetooth technology is turned on |
| | Downloading data | | Wi-Fi network connected with full signal strength |
| | Synchronizing data | | Wi-Fi network connected but no Internet |
| | Error with sync or sign-in | | Ethernet status - connected. |
| | The terminal could not synchronize data with the computer | | SD card is full |
| | GPS is turned on | | Receiving location data from GPS |
| | The Chill timer has expired and computer is cold enough the heaters can be turned on. For more information, see About the CK75 Cold Storage Model Heater (page 20). | | Heaters are turned on. For more information, see About the CK75 Cold Storage Model Heater (page 20). |

About Screen Gestures

Use your fingers or the stylus to manipulate icons, buttons, menus, the on-screen keyboard, and other items on the screen.

- **Tap**
Tap to select something, toggle a setting on or off, or activate a field for text entry. An on-screen keyboard automatically appears for text entry.
- **Tap and hold**
Tap and hold an item but do not lift your finger or stylus until an action occurs.
- **Drag and drop**
Tap and hold an item, and then slide your stylus or finger across the screen until you reach the target position. Lift your finger or stylus off the screen to drop the item in place.
- **Swipe or slide**
Quickly move your finger across the screen, without pausing when you first touch. For example, you can slide a Home screen left or right to view the other Home screens.
- **Double-tap**
Tap quickly twice on a web page, map, or other screen to zoom in. Double-tap again to zoom out.











- **Pinch**
In some apps, you can zoom in and out by placing two fingers on the screen at once and pinching them together (to zoom out) or spreading them apart (to zoom in).





About Honeywell Applications

Honeywell provides several useful applications to help you configure, troubleshoot, and connect your computer to other devices and networks. You can also download additional applications from the Honeywell website at www.honeywellaidc.com to help you use all of the features of your computer.

Applications Available on the Computer

Many of the applications in this table are located in the Power Tools folder. For more information on Power Tools, look for Dolphin Power Tools user guide at www.honeywellaidc.com.

| Icon | Application | Description |
|---|------------------------|--|
|  | AutolInstall Settings | Use to automatically install packages, APKs, and configure during the boot sequence. |
|  | Carrier Select | Use the Carrier Selection application to quickly change your network carrier. |
|  | ConfigApps | Provides a way to disable/enable apps and uninstall updates. |
|  | Configure Autorun | Configure which applications you want to run during the boot sequence. |
|  | Backup | Backup and restore settings and user data. |
|  | BattMon | Monitor the charge status of the battery. |
|  | Demos | Use ScanDemo to demonstrate how the scanner works. You can use it to scan a bar code, set the symbologies it scans, and determine the computer response to a scanned bar code. |
|  | Diagnostic Information | Use the DiagnosticInfo app to view device information, Honeywell Apps, Radio Information, Battery Information, Memory Information, and Scanner Information. |
|  | EZConfig | Configure the device and applications efficiently with bar code and configuration files. |
|  | File Browser | Provides an efficient way to browse files on the computer. |
|  | IPConfig | Use IPConfig to view network adapter information. |

| Icon | Application | Description |
|---|-------------|---|
|  | LogView | Displays LogCat and Dmesg information in real time. |
|  | Ping | Use Ping to verify communication links or to make sure a specific IP address is working. |
|  | Route | Route displays and allows editing of the rules for packet destination across the subnets. |
|  | WiFi Info | Wi-Fi Info enables and disables the Wi-Fi radio, provides information on access points and tracks roaming statistics. |

Applications You Can Download to the Mobile Computer

You can download Honeywell applications to extend the capabilities of the computer. You may need to purchase an license to run some applications. To learn more about the applications described in this section and other Honeywell software solutions, go to www.honeywellaidc.com > **Browse Products** > **Software**.

About Honeywell Enterprise Browser

Enterprise Browser for Microsoft® Internet Explorer® is a locked-down enterprise Web client application designed for Honeywell computers. It provides a controlled Web application environment that helps enterprises increase productivity and reduce IT management expenses. You can configure Enterprise Browser for your specific application requirements and design custom web applications that run through the Enterprise Browser to provide your users with an easy-to-use yet controlled experience.

If Enterprise Browser is not included on your computer model, you can download a trial version for evaluation. After the evaluation period expires, you need to purchase a license. For more information about Enterprise Browser, visit www.honeywellaidc.com.

About Honeywell HTML5 Browser

HTML5 Browser is an open platform HTML5 application environment for select Honeywell mobile computers. HTML5 Browser is free from licensing fees or licensing activation requirements and provides an easy way for developers to run cross-platform applications. Honeywell's HTML5 Browser supports applications designed to run on-line (connected to the web server), off-line (no connection to the web server) or a combination of the two. Data can be stored locally on the device until synchronization with the back-end server is available. HTML5 Browser includes a true web browser application that provides a URL bar, browsing history, favorites list and other elements common to typical web browsers.

HTML5 can be downloaded at no charge from the Honeywell website. For more information, visit www.honeywellaidc.com.

About Honeywell Launcher

Launcher is a configurable locked-down menu program designed for Honeywell computers that prevents end-users from accessing the start menu and other non-authorized applications. Use Launcher to provide a platform where your mobile computer users are limited to running only company-approved applications and prevent them from initiating unauthorized configuration changes. You can also use Honeywell Launcher together with Honeywell Enterprise Browser to create a single-purpose device configuration.

If Launcher is not included on your computer model, you can download a trial version of the software for evaluation. After the evaluation period expires, you need to purchase a license. For more information about Launcher, visit www.honeywellaidc.com.

About Enterprise Terminal Emulator

Enterprise Terminal Emulator (TE) is a terminal emulation client designed for enterprise-level data collection. In a single client, Enterprise TE supports multiple emulation protocols. Its features include session persistence, remote management and configuration, and multiple security options. Enterprise TE provides a consistent user interface and a common menu structure (Enterprise Settings), simplifying the use and management of applications running on Honeywell mobile computers.

If Enterprise TE is not included on your computer model, you can download a trial version of the software for evaluation. After the evaluation period expires, you need to purchase a license. For more information about Enterprise TE, visit www.honeywellaidc.com.

Unlock Developer Options

If you are an application developer, unlock the Developer options to easily test and debug your apps. Once you unlock the feature, **Developer options** appears under the System heading in the Settings app.

1. Start the **Settings** app.
2. Tap **About phone**.
3. Tap **Build number** seven times. A popup message appears informing you that you are now a developer.

This section describes how to use and configure the scanner to scan bar codes.

About the Imager

The internal imager can read 1D and 2D bar code symbologies, composite symbologies, and postal codes. You can also use the internal imager to take pictures as if it were a camera or use the integrated flash as a flashlight.

You can also use Bluetooth communications to connect the computer to cordless scanners, such as the Granit™ 1981i and 1911i.

How to Scan Bar Codes as Keyboard Input

The scan wedge feature sends scanned bar code data to an active application as Android keypad input. To scan a bar code as keyboard input, open an application that accepts text input and then scan a bar code. By default, the scan wedge feature is enabled on the computer.

You can use applications that are coded to use the scanner or applications that receive data through the scan wedge feature. If an application claims the scanner through the BarcodeReader API, the scan wedge feature is temporarily disabled.

You can find information on how to create custom applications for the computer in the *Honeywell Mobility SDK for Android*, available from the Honeywell Technical Support Downloads Portal at <https://hsmftp.honeywell.com>. Once you create an account and enter the portal, navigate to **Software > Software and Tools > Developer Library > SDKs for Android**.

Change the Scanner Settings

Changes you make to the Default profile apply to all applications with no profile.

1. Tap **All Apps > Settings**.
2. Tap **Scanning**.
3. Tap **Internal Scanner > Default Profile**.
4. Select from the following:
 - Data Processing Settings,
 - Symbology Settings,
 - Decode Settings,
 - Imager Settings,
 - Trigger Settings, or
 - Notification Settings.
5. Modify the settings to meet your application needs.

Restore Default Scanner Settings

You can easily discard all changes you made to the Default profile and restore the default values.

Note: *When you select to restore the default values of one of the settings, it also restores the default values of all settings within the profile.*

1. Open the **Default profile**.
2. Tap  in the upper right corner of any of the scanner settings screens.
3. Tap **Restore all defaults**.

Add a Scanning Profile

To create a scan setting profile for a custom app on the computer:

1. Touch **All Apps > Settings > Scanning**.
2. Touch **Internal Scanner**.
3. Touch  in the upper right corner of the screen.
4. Tap the profile name field and add a name using the keypad or tap the **select an application** and choose an app from the list.

The new profile appears on the Internal Scanner profile list. You can now select and modify the scan settings of the new profile.

About the On-Screen Keyboard

If you want to use the on-screen keyboard when you input a new profile name:

1. Tap the profile name field.
2. Tap the keyboard icon in the lower right corner of the screen.
3. Tap the on/off button next to **Show input method enable** the on-screen keyboard. You may have to select the add profile icon again.

Delete a Scanning Profile

Open the Internal Scanner profile list. Tap and hold the profile you want to delete, and then select **Delete**.

Scan Bar Codes

The internal imager supports omni-directional (360°) bar code scanning. An aiming beam is provided to help assist with targeting when scanning bar codes.

Note: Before you start scanning bar codes, use the Settings app to enable only the bar code symbologies that you need. By reducing the active symbology list, you can increase the scan speed.

1. Point the computer at the bar code. For optimum performance, avoid reflections by scanning the bar code at a slight angle.
2. Press and hold the Scan button.
3. Center the aiming beam over the bar code. When the scanner successfully reads the bar code, the computer beeps, and the Good Read LED turns on briefly. The bar code information is entered into the application in use.

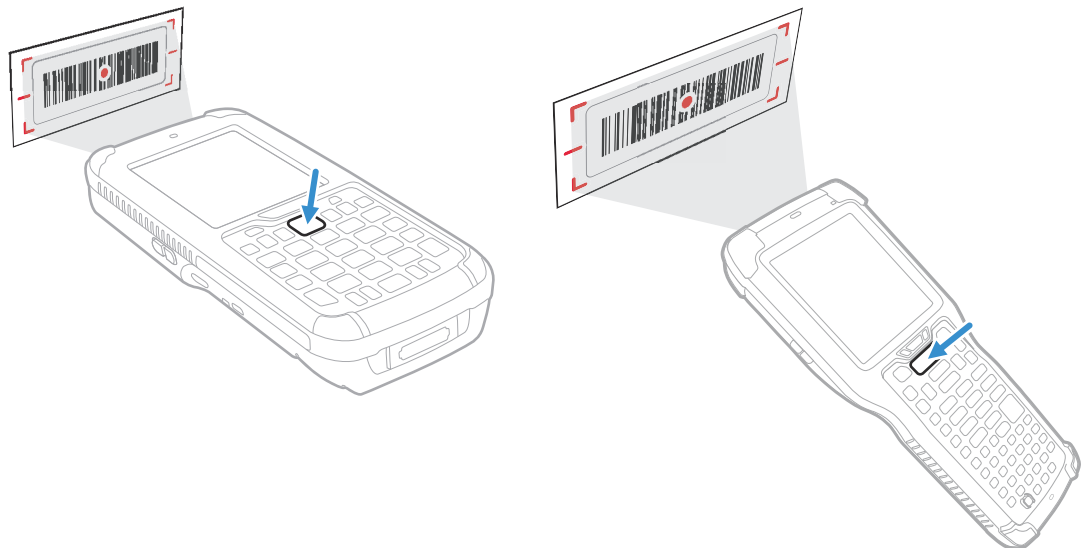

4. Release the Scan button.

Use the Scan Demo App

Use the Scan Demo app to read bar codes, or to test your symbology decode settings.

1. Tap **All Apps > Demos**.
2. Swipe left or right on the screen until the **Scan Demo** app is selected. The selected application is listed below the turntable.
3. Tap on the center of the box image to open the app.
4. Aim the scanner window at the bar code and press and hold the **Scan** button.
5. Center the aiming beam over the bar code. When the scanner successfully scans the bar code, the computer beeps, and the Good Read LED briefly turns on. A list of bar code information appears.

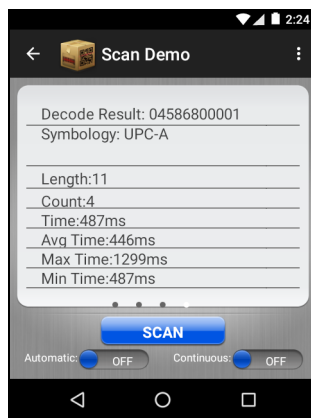

Note: In the Scan Demo app, not all bar code symbologies are enabled by default. If a bar code does not scan, the correct symbology may not be enabled.

How to Change the Default Symbology Settings in the App

To enable or disable decoding for specific symbologies:

1. In the Scan Demo app, tap **⋮** and select **Symbology Settings**.
2. Tap the box next to a symbology name to enable (check mark) or disable (no check mark) decoding for that symbology.
3. (Optional) Tap the Symbology name to see and modify additional configuration settings for the symbology selected.

Use the Imager as a Flashlight

To use the imager as a flashlight.

1. Open Quick Settings.
2. Tap the **Flashlight** icon. Select again to turn the flashlight off.

USE THE PHONE

You can use the phone feature to make and receive telephone calls, as well as transmit data through wireless world wide area networks (WWAN).

Note: Phone features are only supported on CN75 and CN75e WWAN models (CN75WAN).

About the Phone

Phone features on the computer include a speaker and a microphone. You can also use a Bluetooth headset or hands-free kit.

On CN75 and CN75e WWAN models the phone feature is enabled by default and a Flexible Network Radio provides the ability to connect to CDMA or UMTS networks in all regions that support these technologies. The flexible network radio is a software-defined radio (SDR) that can be configured for CDMA or UMTS depending on your wireless communication needs.

After you turn on the phone and activate service with your wireless carrier, you can customize the phone features and network settings in the Wireless & networks section of the Settings app.

Note: The WWAN radio supports Network Information and Time Zone (NITZ) messages to automatically set the system time.

How to Add and Switch Between Network Carriers

The SDR radio in CN75 and CN75e WWAN models makes it easy for you add carriers and switch between them as needed.

Use the Carrier Selection app to quickly change your WWAN radio network carrier.

1. Tap **All Apps > Carrier Selection**.

2. Tap and hold **--Please Select--**, and then select a carrier from the list.

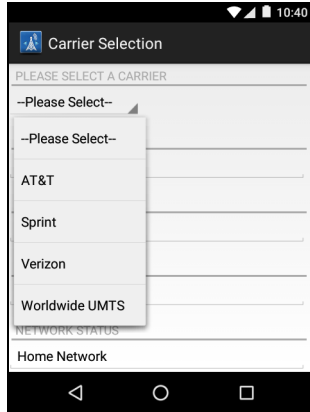

3. Tap **OK** to confirm carrier change.
 - If the update is successful, the Carrier Selection screen appears and displays the updated carrier information.
 - If the update is unsuccessful, a message box appears. Tap **Ok** to return to the Carrier Selection screen.

Activate the UMTS Phone

You use a SIM card to activate the UMTS phone on your CN75/CN75e WWAN model computer. You can purchase the SIM card from your network provider. A Phillips screwdriver is needed to install the SIM card.

Note: Phone features are only supported on CN75 and CN75e WWAN models (CN75WAN).

1. Select a network carrier. For more information, see [How to Add and Switch Between Network Carriers](#) on page 49.
2. Press the **Power** button, and then select **Power off**.
3. Detach one end of the hand strap from the computer (see page 8).
4. Push the battery latch toward the bottom of the computer until the battery releases, and then lift the battery away from the computer.
5. Remove the two Phillips screws and open the card access door.

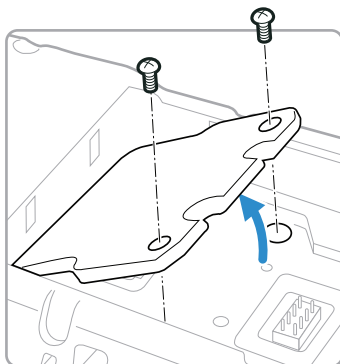

- Slide the SIM card holder to the left and up.

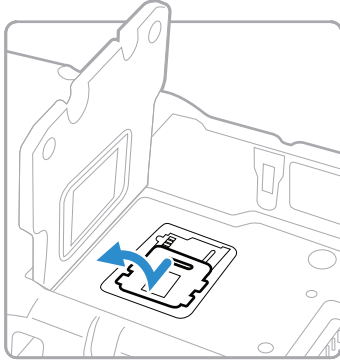

- Place the SIM card in the holder with the contacts facing away from the holder.

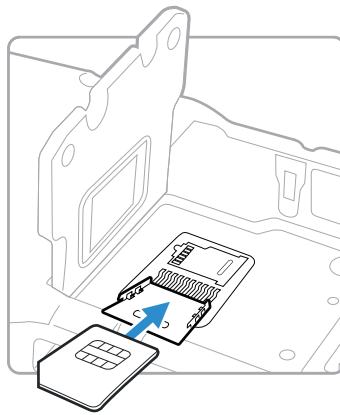

- Close and latch the SIM card holder.

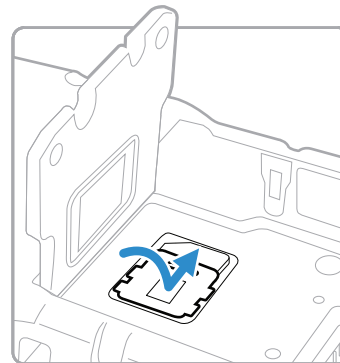

- Close the card access door and install the two screws.
- Insert the top end of the battery into the computer, and press down firmly on the bottom until the battery clicks into place. Make sure that the battery latch is fully engaged.
- Attach the hand strap.

12. Press the **Power** button.

Note: AT&T network users, tap **Yes** if prompted to allow automatic connection selection for the SIM card. If you are using a custom APN, select **No**. You must manually configure the connection instead of using the automatic option. Connection charges may apply.

Activate the CDMA Phone

To activate the CDMA radio module in your mobile computer, you need to contact your wireless carrier and set up an account.

You also need to provide the carrier with the Mobile Equipment Identifier (MEID) for the computer. You can find the MEID:

- on a label located in the battery compartment.
- on the outside of the computer shipping box.

Note: For the CDMA phone, settings are permanently stored in the WWAN radio after activation. CDMA settings persist through a factory data reset.

The activation process is slightly different for each CDMA carrier. In general, you need to contact your wireless provider and give the provider the MEID for the computer.

1. Select a network carrier. For more information, see [How to Add and Switch Between Network Carriers](#) on page 49.
2. Contact your wireless provider and give the provider the MEID for the computer.
3. If your carrier is Sprint, reboot the computer. As soon as the Sprint network detects your phone, Hands-Free Activation (HFA) begins, and a series of notification messages appear. When activation is complete, a completion message appears and the WWAN radio reboots. The phone is ready to use.

If your carrier is Verizon, tap **Phone** , enter ***228** on the phone keypad, and press **Talk**. After a short wait, a message appears, confirming either success or failure of the activation. After successful activation, the phone is ready to use.







Note: Data connections are to the public domain on your network.

Make a Phone Call

Once the phone is activated, you can make a phone call.



Note: Phone features are only supported on CN75 and CN75e WWAN models (CN75WAN).

1. On the **Home** or **All Apps** screen, tap .

2. Use one of the methods below to enter the telephone number you want to call.
 - Press the numbers on the computer keypad.
 - Tap  and use the on-screen dialer.
 - Select a person on your saved contact list .
 - Select a favorite on your speed dial list .
 - Select a number from the recent calls list .
3. Tap call .
4. To end the call, tap end call .

Answer a Phone Call

When you receive a phone call, the Incoming Call screen opens. If the caller telephone number is available, it appears on the screen. Depending on your calling plan, you may also see a Caller ID information. All incoming calls are recorded in the Call log. If you miss a call, you receive a notification.

1. On the Incoming Call screen, tap and hold the white call icon.
2. Three icons appear:
 - To answer the call, drag the icon to .
 - To send the caller directly to voice mail, drag the icon to .
 - To send a txt message back to the caller instead of answering, drag the icon to .

Make an Emergency Phone Call

You can use the phone to make an emergency phone call even if the SIM card is missing from your UMTS phone or if you do not have a valid CDMA account. The phone shows no service but the call still goes through if you dial certain emergency numbers (e.g., 112, 911, 000, 08, 118, 119, and 999).

Configure Phone Settings

You can customize settings for the phone, including the ringtone, voicemail options, keypad tones, internet call settings, and other options.

1. Tap .

2. Tap  next to the microphone icon.
3. Select **Settings**. The Call settings menu appears.
4. Change phone settings as necessary.

USE THE CAMERA

Learn to use the color camera to take pictures and record videos, read bar codes, perform document capture, or perform signature capture.







About the Color Camera

The camera lens and flash are located on the back of the computer.

You can open the Camera app  from the Favorites tray on the Home screen or from the All Apps screen. Use the Camera app capture pictures or videos.



Use the Photos app  to view, organize, edit and share photos and videos stored on the computer. The Photos app can be opened from the Home screen or All Apps screen. By default the photos and videos captured with the Camera app are saved on the computer under Internal storage\DCIM\Camera.

Take a Picture

1. In the All Apps screen, tap **Camera** .
2. Using the screen as a viewfinder, move the computer until you see the image you want.
3. Tap the screen to set the focus point. By default, the camera senses the lighting in the environment and turns the torch (flash) on if needed.
4. Press the **Enter** key or tap . The camera takes a picture and a small thumbnail image of the picture appears.
 - To view the picture, tap the thumbnail image or swipe to the left.
You can share , edit , or delete  the video.
 - To return to the Camera app, tap .

Change Basic Camera Settings

You can change the camera settings for best results when taking pictures.





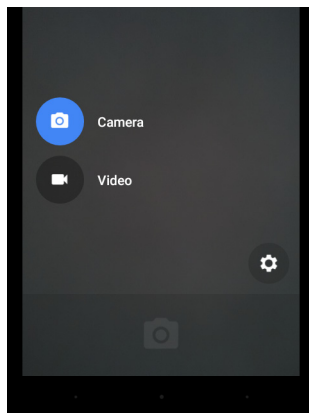

1. In the All Apps screen, tap Camera .
2. Tap  to view the camera options.
3. Tap one of the icons to change basic camera settings.
 - Timer: Set the amount of time from when you tap the Camera icon until it takes a photo. Options for the timer are 3 seconds or 10 seconds.
 - Grid: Turn on a grid to help you frame your photos. Options for the grid are enabled or disabled.
 - Flash: Turn on the flash to take photos in low light conditions. Options for flash are on, off, and automatic.

Record a Video

You can record video with the camera in the computer.



1. In the All Apps screen, tap Camera .
2. When the Camera screen appears, swipe to the right. This menu appears:





3. Tap . The Video screen appears.
4. Tap  to begin recording video.
5. When you are done recording, tap .
 - To view the captured video, swipe left and tap . You can share  or delete  the video.
 - To return to the Camera app, tap .

Change Basic Video Settings

You can change the camera settings for best results when recording video.

1. In the All Apps screen, tap Camera .
2. When the Camera screen appears, swipe to the right.
3. Tap . The Video screen appears.
4. Tap  to view the video options.
5. Tap the grid or the flash icon to turn the option on or off.

Change Advanced Camera App Settings

1. In the All Apps screen, tap Camera .
2. When the Camera screen appears, swipe to the right.
3. Tap .
4. Tap a setting to modify.
 - **Resolution & quality:** Set photo resolution and video quality.
 - **Save location:** Enable or disable saving location information with captured pictures and videos.
 - **Advanced:** Enable or disable manual exposure feature.

CONFIGURE THE COMPUTER

Use this chapter to learn about the available methods for configuring your mobile computer. You can also use this chapter to learn how to configure network communications and wireless security.

How to Configure the Computer

You can configure many parameters on the computer such as the bar code symbologies it decodes or the network settings. The values you set for these parameters determine how the computer operates.

Start the Settings App

You can access the Settings app through the All Apps menu or Quick Settings.

- Tap **All Apps > Settings**  or open the Quick Settings and select .

About the Structure of the Settings App

Use this section to learn about the structure of the Settings app so you can find parameters quickly.

| Wireless & Networks Settings | Description |
|------------------------------|--|
| Wi-Fi | <ul style="list-style-type: none"> • Turn Wi-Fi radio on or off. • Lists available Wi-Fi networks in range when the radio is turned on. • View saved networks. • Add a network Wi-Fi connection. • Access advanced Wi-Fi options. |

| Wireless & Networks Settings | Description |
|------------------------------|--|
| Bluetooth | <ul style="list-style-type: none"> Turn the Bluetooth radio on or off. Lists Bluetooth enabled devices in range when the radio is turned on. Connect to a Bluetooth Device. Rename the computer. Show received files. |
| Ethernet | <ul style="list-style-type: none"> Turn Ethernet configuration on or off. Configure Ethernet connections and set up proxy settings when Ethernet is turned on. |
| Data usage | <ul style="list-style-type: none"> Displays a list of phone data usage for the current data usage cycle. Tap the Data usage cycle list to select another date range. |
| More | |
| Airplane | Turn Airplane mode on or off. |
| Tethering & portable hotspot | <ul style="list-style-type: none"> Enable or Disable USB tethering or Bluetooth tethering Enable or Disable using the computer as a portable Wi-Fi hotspot. Configure Wi-Fi hotspot. |
| VPN | Set the password parameters for a virtual private network (VPN) connection. |
| Cellular networks | Modify mobile network settings, including enabling data access and roaming over mobile networks, selecting access points and network operators, or selecting only 2G networks (to save battery life). |
| Mobile plan | Provides information on your cell phone plan. |

| Device Settings | Description |
|----------------------|--|
| Display | <p>Adjust display settings.</p> <ul style="list-style-type: none"> Set Brightness level or turn Adaptive brightness on or off. Set the wallpaper. Set Sleep mode timeout length (minutes). Enable and configure the daydream feature. Set screen font size, Turn screen auto-rotation on or off. |
| Sound & notification | <ul style="list-style-type: none"> Adjust volume levels for media, alarms, and rings (phone calls and notifications). Set the phone ringtone and turn vibration during call ringing on or off. Configure the Do not disturb feature. Turn sounds on or off for touch, charging, screen lock, dial pad tones. Set when app notifications show. |

| Device Settings | Description |
|------------------------|--|
| Apps | <ul style="list-style-type: none"> • View a list of downloaded and running apps. • Access app configuration (e.g., permissions, links, defaults, power setting). • Reset app preferences. |
| Storage & USB | <ul style="list-style-type: none"> • View Internal storage statistics. • Eject or mount optional microSD card. • View microSD card content in standard browser format. |
| Battery | <ul style="list-style-type: none"> • Shows battery usage data and the current battery state. • Access Battery Saver and Battery Optimization features. |
| Memory | View statistics about the average memory use and memory used by apps. |
| Users | <ul style="list-style-type: none"> • Modify the owner profile name and add profiles other people who use the computer. • Activate a different user profile. |

| Honeywell Settings | Description |
|---------------------------|--|
| Battery LED | Set the battery LED status behavior. Options include: HSM Battery LED (the Honeywell default), the Android Default LED, or No Battery LED. |
| Battery info | View battery information, including status, serial number, health, voltage and current, and other useful data. |
| Logger | Enable or disable a logging service that creates an Android logcat log and kernel log for app and system troubleshooting. |
| Key Remap | Change (remap) a button or key function. |
| Scanning | Configures the imager. |
| Web applications | Enables access for the Honeywell Mobility SDK for Web apps and lets you set a port. |

| Personal | Description |
|-----------------|--|
| Location | <ul style="list-style-type: none"> • Turn location services (Google and GPS satellite data) on or off. • Set location mode accuracy. • View location request history. |
| Security | <ul style="list-style-type: none"> • Set device security settings (e.g., screen lock). • Encrypt phone. • Manage administrator privileges. • Manage credentials. • View app usage access. |
| Accounts | Add a corporate or email account to the computer. |
| Google | Create and manage Google accounts and services. |

| Personal | Description |
|------------------|--|
| Language & input | <ul style="list-style-type: none"> Set the active language and default keyboard (on-screen and physical keyboard). Configure auto-typing features such as capitalization, punctuation, spell check, and the personal dictionary. Set text-to-speech output. Adjusts the pointer speed for an external mouse or trackpad. |
| Backup & reset | <ul style="list-style-type: none"> Turn data backup to Google servers on or off. Configure data backup. Reset network settings. Restore factory default settings. |

| System Settings | Parameter You Can Configure |
|-------------------|---|
| Date & time | Configure all date and time settings. |
| Accessibility | Set accessibility levels, such as larger display text and enabling text-to-speech output. |
| Printing | Configure the printing options. |
| Developer options | Enables developer-specific options such as USB debugging and SD card protection. |
| About phone | Lists device-specific information including the model number, phone number, operating system version, software patch version, radio versions, build number and legal information. |

About Network Communications

You can easily add the mobile computer to your wireless or wired data collection network. You can connect your computer using:

- 802.11a/b/g/n radio communications.
- Ethernet communications.
- Bluetooth communications.
- USB and serial communications.

Connect to a Wi-Fi Network



The mobile computer contains an 802.11a/b/g/n radio to transfer data using wireless communications. Before you connect to a Wi-Fi network, you need to know about your network security protocol and its required credentials.

By default, the 802.11 radio is disabled.

1. Tap **All Apps > Settings > Wi-Fi**.

2. Tap the Wi-Fi on/off switch to turn the radio **On**  . A list of discovered networks appears.
3. On the list, tap the network name to initiate a connection.

To add a network to the list:

- a. Tap  , and then select **Add network**.
 - b. Type the Wi-Fi network name (SSID).
 - c. Choose a security protocol and add any required information.
Press the down key  if you do not see the Security field.
 - d. Tap **SAVE**.
4. Enter any required information if the network is secured (e.g., password, key or certificate name).
 5. Tap **CONNECT**.



Once you have saved and connected to a Wi-Fi network:

- Tap the Wi-Fi network name on the list to view details (e.g., status, signal strength, speed, frequency, security type). Select **CANCEL** to close details screen.
- The computer automatically connects to the same network when the network is in range and the Wi-Fi radio is turned on.
- To remove a network from your saved list, tap and hold the network name and select **Forget network**. You can do this for networks you no longer use.
- To modify a network from your saved list, tap and hold the network name and select **Modify network**. You can do this if you changed your network password.
- To view a list of your saved networks, tap  and then select **Saved networks**.

Configure Proxy Settings for a Wi-Fi Network

If you need to connect to network resources through a proxy server, you can configure settings for the proxy server for each Wi-Fi network you add. By default, the Wi-Fi networks you add are not configured to connect through a proxy server.



Note: *Proxy settings apply only to the Wi-Fi network you modify. You must change proxy settings for each network requiring a proxy server.*

1. Tap **All Apps > Settings > Wi-Fi**.
2. Verify **Wi-Fi** is turned **On**  .
3. Tap and hold the connected network name, and then tap **Modify network**.
4. At the bottom of the list of network settings, select **Advanced options**.
If needed, press the down key  to move to the bottom of the list.
5. Under **Proxy**, tap  to open the menu, and then tap **Manual**.

6. Enter the proxy settings for the network.
7. Tap **Save**.

Disable Wi-Fi Notifications

By default, when Wi-Fi is enabled, you receive notifications in the Status bar when the computer discovers a wireless network. You can disable these notifications.

1. Tap **All Apps > Settings > Wi-Fi**.
2. Tap , and then select **Advanced**.
3. Tap the **Network notification** switch to disable  notifications.

Connect to an Ethernet Network

To connect the computer to an Ethernet network, you need an Ethernet dock.

1. Make sure the dock is connected to your Ethernet network.
2. Place the computer in the dock.
3. Tap **All Apps > Settings > Ethernet**.
4. Verify Ethernet is **On** .
5. Tap **Ethernet**. The Ethernet list shows the name of the current Ethernet connection. By default, the computer assumes a DHCP connection, and that your network has assigned an IP address automatically. If DHCP is working, the Ethernet dock should indicate that communication with the network is occurring.
6. (Optional) To assign a static IP address.
 - a. Tap the connection name (for example, eth0).
 - b. Tap **DHCP** and then select **Static** from the list.
 - c. Enter the required network information, and then tap **Apply**.

How to Connect to Virtual Private Networks

The computer supports connecting to virtual private networks (VPNs). This section describes how to add and connect to VPNs. To configure VPN access, you must obtain details from your network administrator.

You manage VPN connections in the Settings app.

Note: Before you can add or connect to a VPN network, you must enable a screen lock method.

Add a VPN

Before you can connect to a VPN, you must create a VPN profile.

1. Tap **All Apps > Settings > More > VPN**.
2. Set up a screen lock security method if prompted.
3. Tap **+** to add a VPN new profile.
4. Enter the required information for the VPN.

If needed, press the down key **▼** to access all the required information fields.

5. Tap **Save**. The VPN name appears in the VPN list.

Connect to a VPN

Once a VPN profile is created, you can connect to the VPN.

1. Tap **All Apps > Settings > More > VPN**.
2. Tap the name of the VPN in the list.
3. Enter any necessary credentials when prompted.
4. Tap **Connect**. The computer connects to the VPN, and a Status icon **🔑** and notification appear.

To disconnect from the VPN, tap the notification.

Edit VPN Information

Editing an existing VPN profile can also be done from VPN screen.

1. Tap **All Apps > Settings > More > VPN**.
2. Tap **⚙️** to the right of the VPN profile you want to edit.
3. Edit the VPN settings as necessary.
4. When you are done, tap **Save**.

About Wireless Security

The computer provides these security solutions for your wireless network:

- Wi-Fi Protected Access 2 (WPA2™)
- Wi-Fi Protected Access (WPA)
- 802.1x
- LEAP (Funk security only)
- WEP

Honeywell recommends WPA2 security with PSK (Personal) or 802.1x (Enterprise) key management.

Before you set security, you need to enable the radio, set the date, and set the SSID on your computer. To use 802.1x security, you need to load a root certificate on your computer. To use transport layer security (TLS) with 802.1x security, you also need to load a user certificate.

About Certificates

You can use digital certificates to identify the computer for network access or authentication to servers. To use a certificate to identify your device, you must install it in the trusted credential storage on the computer.

Android supports DER-encoded X.509 certificates saved in files with a .crt or .cer file extension. To install a valid certificate with a .der or other extension, you must change the extension to .crt or .cer to install it.

Android also supports X.509 certificates saved in PKCS#12 key store files with a .p12 or .pfx extension. To install a valid key store file with another extension, you must change the extension to .p12 or .pfx to install it. When you install a certificate from a PKCS#12 key store, Android also installs any accompanying private key or certificate authority certificates.

Load a Certificate

To use a certificate, you must install it in the trusted credential storage on the computer.

Note: *Apps such as email and browsers that support certificates allow you to install certificates directly from within the app. For more information, see the help that comes with the app.*

1. Copy the certificate or key store from your PC to a microSD card.
2. Install the microSD card in the computer and turn the computer on.
3. Tap **All Apps > Settings > Security**.
4. Under Credential storage, tap **Install from SD card**.
5. Tap the name of the certificate or key store to install it. If prompted, enter the key store password and then tap **OK**.
6. Enter a name for the certificate and tap **OK**.

Disable or Remove Certificates

If a user or system certificate is compromised, or your organization chooses not to trust it, you can disable or remove the certificate.

Note: *If you remove a User certificate, you must install it again to enable it.*

1. Tap **All Apps > Settings > Security > Trusted credentials**.

The trusted credentials screen has two tabs:

- **System** shows CA certificates that are installed in the ROM.
 - **User** shows CA certificates you have installed yourself.
2. Tap the name of the certificate to disable or remove. The certificate details screen appears.
 3. Scroll to the bottom of the details screen and tap **Disable** (for System certificates) or **Remove** (for User certificates).
 4. Tap **OK**.

About Bluetooth Communications



Your mobile computer is equipped to communicate with other devices using Bluetooth technology. You need to turn on the Bluetooth radio before you can discover, pair and connect to other Bluetooth devices. By default, the radio is turned off. System bar icons indicate Bluetooth status.

Note: *The Bluetooth radio maintains its current state through a system reset. If you perform a factory data reset, you must recreate pairings to devices.*

How to Turn the Bluetooth Radio On/Off

You need to turn on the Bluetooth radio in the mobile computer before you can discover and connect to Bluetooth devices. By default the radio is turned off.

Note: *When the Bluetooth radio is enabled, the computer is visible to nearby devices.*

1. Tap **All Apps > Settings > Bluetooth**.
 2. Tap the Bluetooth on/off switch to turn the radio **On** .
- The  icon appears in the status bar and a list of available Bluetooth devices appears.

Pair and Connect a Bluetooth Device

Once you turn on the Bluetooth radio, you can pair and connect with other Bluetooth enabled devices.

Note: *When the Bluetooth radio is enabled, the computer is visible to nearby devices.*

1. Tap **All Apps > Settings > Bluetooth**.
2. Verify the radio is turned **On** .

A list of available Bluetooth devices appears.

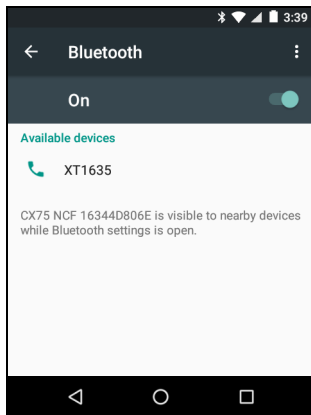



3. (Optional) If the device you want does not appear in the list, make sure the device is turned on and set to discoverable, tap , and then tap **Refresh**.
4. Tap a device on the list to initiate a pairing request.
5. When the pairing request message appears, verify the Bluetooth pairing code is the same on both devices and then tap **Pair**.

If the pairing request requires a **PIN**, enter the **PIN** and tap **OK**.

When the device is paired with the computer, the device name appears under Paired Devices at the top of the list.

6. (Optional) Once paired to a device, you can connect manually to the device. Tap the paired but unconnected device.

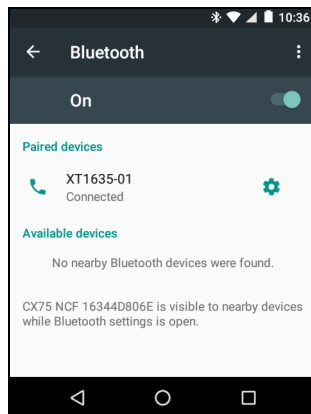

When the computer and paired device are connected, they show as connected in the list. The status icon changes from  to .



- To disconnect a paired device, tap the name of the paired device and then tap **OK** when the Disconnect? screen appears.
- To unpair a device, tap the  next to the device and then select **Forget**.

Rename the Computer

You can change the computer Bluetooth name from the Settings app.

1. Tap **All Apps > Settings > Bluetooth**.
2. Tap the Bluetooth on/off switch to turn the radio **On** .
3. Tap , and then select **Rename this device**.
4. Type the new name, and then tap **OK**.

View a List of Received Files

You can view a list of files received through the computer's Bluetooth connections with other devices.

1. Tap **All Apps > Settings > Bluetooth**.
2. Tap , and then select **Show received files**. A list of files received through the Bluetooth connection appears.

About Serial and USB Communications

You can use these 75 Series accessories to transmit data to and receive data from another device through serial or USB communications:

- RS-232 Snap-On Adapter (Model 1000AA03)
- USB Snap-On Adapter (Model 1000AA07)

For information on these accessories, contact your local sales representative.

How to Share Your Mobile Data Connection

You can share the mobile data connection through USB tethering or Bluetooth tethering. You can also use the computer as a Wi-Fi hotspot to share the connection with other devices.

Share the Data Connection Through USB

After you connect the computer to another device through USB, you can share the data connection through USB tethering.

1. Connect the mobile computer to another device through a USB dock, cable, or other connection.
2. Tap **All Apps > Settings > More**.
3. Tap **Tethering & portable hotspot**.

4. Tap **USB tethering** to enable feature. The device is now sharing the computer data connection.

To stop sharing the connection, disconnect the USB cable, or disable USB tethering.

Share the Data Connection Through Bluetooth

If your device is Bluetooth-capable, you can configure the computer to share its mobile data connection with the device through Bluetooth.

1. Tap **All Apps > Settings > More**.
2. Tap **Tethering & portable hotspot**.
3. Tap **Bluetooth tethering** to enable feature. You should now be able to pair your device with the computer to share the data connection.
4. To stop sharing the data connection, tap the on/off switch to disable Bluetooth tethering.

Share the Data Connection as a Portable Hotspot

You can configure the computer to act as a portable Wi-Fi hotspot for up to eight other devices.

1. Tap **All Apps > Settings > More**.
2. Tap **Tethering & portable hotspot**.
3. Tap **Portable Wi-Fi hotspot** to enable feature. The computer begins to broadcast its network name (SSID) so you can connect to it with up to eight other devices.
4. To restrict access to the computer when you are using it as a Wi-Fi hotspot, tap **Set up Wi-Fi hotspot** to select the security protocol and set up a password.

When other devices try to connect to the hotspot, users are prompted to enter the password before the devices are allowed to connect.

Or, to remove secure access, select Open from the Security list.

5. Tap **Save**.

MANAGE AND MAINTAIN THE COMPUTER

Use this chapter to understand how to upgrade software, reset the computer, and maintain the computer.

About File Transfers Through a USB Connection

To transfer files you need to physically connect the mobile computer to your desktop PC through a USB connection. File transfer through a USB connection is disabled by default. You need to configure the USB connection for transferring files or photos. USB tethering must be turned off before you can transfer files through USB. To learn more, [How to Transfer Files](#) on page 32.

How to Update the System Software

You can use these methods to update the system software on the computer:

- You can update individual computers, or multiple computers at the same time, using a device management system. For help, see the documentation for your device management system.
- You can update individual computers by copying the software update file to the internal storage (or an installed microSD card) on each computer. Then you can manually start the system update from the Settings app.

Update Computers Using a Device Management System

You can update multiple computers at the same time using a device management system. Several mobile device management systems support the 75 Series mobile computers powered by Android, including SOTI MobiControl, Honeywell Skynax™ Mobility Management System, and other third-party solutions. Contact these suppliers for information about obtaining their agent or client software for use with the 75 Series.

Upgrade the System Software

Upgrades for Power Tools and other system software on the computer are provided as compressed .zip files and are available from the Honeywell Technical Support Downloads Portal at <https://hsmftp.honeywell.com>.

1. Copy the upgrade .zip file into one of these folders on the computer:
 - Internal storage\honeywell\autoinstall
 - IPSM card\honeywell\autoinstall
 - \honeywell\autoinstall (on a microSD card if installed)
2. Tap **All Apps > Autoinstall Settings**.
3. Verify that **Autoinstall** is enabled.
4. Select **Packages Update** from the screen. The computer automatically initiates a reboot and installs the software upgrade.

Reset the Computer

You may need to restart the mobile computer to correct conditions where an application stops responding to the system or the computer seems to be locked up. You may lose data in open apps when you reset the computer. All your settings are saved during a reset.

1. Press and hold the **Power** button until the options menu appears.
2. Tap **Reset**.
3. Tap **OK** to confirm. The computer restarts.

To restart the computer if the touch panel display is unresponsive:

- Press and hold the **Power** button for approximately 8 seconds until the computer restarts.

Perform a Factory Data Reset



Caution: Performing a factory data reset completely erases all data, files, and downloaded apps from the computer memory. Back up your data and files before proceeding.

You can perform a factory data reset, which restores all default settings on the computer and erases all data, files, and downloaded apps. Because a Factory reset can result in data loss, use it only after trying a standard restart and if all other recovery methods have failed.

Note: *These methods of recovery may not be available if your system administrator has set policies to prevent their use.*

Factory Reset: Method 1

Use this Factory Reset method if you want a clean configuration without any of the custom apps, settings, and data you added to the computer.

Before You Start

- If you recently reset your Google Account password, wait 24 hours before performing a Factory reset.
- Make sure you have your screen lock password, PIN or pattern if you activated one. You will need this to reset the computer.
- If you have a Google Account, back up your data and settings to your Google Account so you can restore them if needed.
- Connect the computer to an external power source or make sure you have a full battery charge.
- Make sure you have an Internet connection.

To Perform a Factory Reset Using the Touch Screen

1. Tap **All Apps** > **Settings** > **Backup & reset**.
2. Select **Factory data reset**.
3. If you also want to erase all data in the IPSM partition as well as internal storage, swipe to the bottom of the screen and check the box next to **Erase IPSM**.
4. Tap **RESET PHONE**.
5. If prompted, enter your screen lock security pattern, PIN or password.
6. Tap **ERASE EVERYTHING**. The computer indicates a factory reset is in progress. When the process is finished, the computer restarts and the initial set up screen appears.

Factory Reset: Method 2

You should never use this method unless all other recovery methods have failed and the computer is still completely unresponsive.

Before You Start

- If you added a Google Account to the 75 Series computer, make sure you have your Google username and password associated with the computer. If you do not have the username and password, you will not be able to use the computer after the reset. This is a security measure that prevents unauthorized users from using the device if they try a factory reset.

If you did not add a Google Account to the computer, the extra security level is not enabled and you will not need a Google username and password.

- If you recently reset your Google Account password, wait 24 hours before performing a Factory reset.
- Connect the computer to an external power source or make sure you have a full battery charge.
- Make sure you have an Internet connection.

To Perform a Factory Reset for an Unresponsive computer

To perform a Factory Reset if the 75e is unresponsive and all other recovery methods have failed:

1. Press and hold the **Power** button for approximately 8 seconds until the computer starts to reboot.
2. When the Honeywell splash screen appears, press and hold the **Power** and **Volume down** buttons until the Recovery screen appears.
3. Verify “Recovery Mode” appears at the top of the screen.
If “Recovery Mode” does not appear, press either Volume button to move through the options until “Recovery Mode” appears.
4. Press the **Power** button to enter the advanced options screen.
5. Use the **Volume down** button to highlight **Wipe data/factory reset**.
6. Press the **Power** button.
7. After the reset is complete, press the **Power** button to reboot.

Clean the Computer

To keep the computer in good working order, you may need to clean the scanner window, color camera window, and the touch screen. Clean the windows and the touch screen as often as needed for the environment in which you are using the computer. To clean the computer, use one of these recommended cleaning agents:

- Acetic acid, 10% in water
- Ethyl alcohol, 10% in water
- Mild soap solutions
- 5% to no more than 10% bleach or sodium hypochlorite with water

Caution: There are no user-serviceable parts inside the main body of the computer. Opening the computer will void the warranty and may cause damage to the internal components.



Note: The installation or replacement of the 75 series computer battery, a microSD card and/or SIM card as described in this user manual does not void the warranty.

Honeywell recommends that you leave the battery installed and on CK75 models the SD Card Door installed when you clean the computer as described.

1. Press the **Power** button to suspend the computer.
2. Dip a clean cloth towel in the cleaning agent and wring out the excess.
3. Wipe off the scanner window, camera lens, and flash area. Do not allow any abrasive material to touch these surfaces.
4. Wipe dry with a clean, soft, dry cloth.
5. Allow the computer to fully air dry before using again.

Computer Agency Information

All 75 Series mobile computers meet or exceed the requirements of all applicable standards organizations for safe operation. The best way to ensure safe operation is to use the mobile computer according to the agency guidelines on the product regulatory sheet, quick start guide and in this user guide. Read all guidelines before using your computer.

Product documentation is available for download from www.honeywellaidc.com. Public certificates are available for download from www.honeywellaidc.com/compliance.

Label Locations

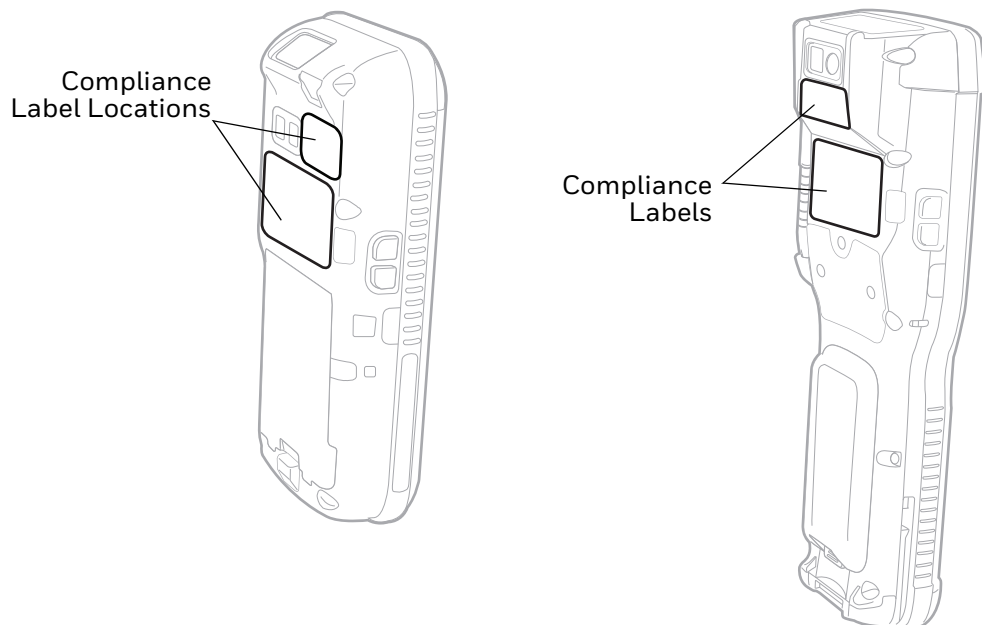

Physical and Environmental Specifications

This section lists the physical and environmental specifications for the computer.

Note: Product data sheets are available for download at www.honeywellaidc.com.

CN75/CN75e

| Parameter | Specification |
|---|---|
| Physical Dimensions (Battery Included) | |
| Length (CN75) | 16.9 cm (6.65 in) |
| Length (CN75e) | 19.5 cm (7.66 in) |
| Width | 8.0 cm (3.16 in) |
| Depth | 3.4 cm (1.34 in) |
| Weight (CN75) | 450 g (15.9 oz) |
| Weight (CN75e) | 491 g (17.3 oz) |
| Tumble and Drop | |
| Tumble Specifications | 2,000 (1 m) tumbles per IEC 60068-2-32 specification |
| Drop Specifications | 2.4 m (8 ft) to concrete per MIL-STD 810G; 1.8 m (6 ft) to concrete across operating temperature range per MIL-STD 810G |
| Power and Electrical | |
| Rechargeable Li-ion battery pack | Model 1000AB02 (PN 318-043-033) |
| Battery configuration | 1S2P (1 cell in series and 2 cells in parallel) |
| Nominal output and capacity | 3.7 VDC, 4000 mAh (14.8 Wh) |
| Environmental | |
| Operating temperature | -20°C to 60°C (-4°F to 140°F) |
| Storage temperature | -20°C to 60°C (-4°F to 140°F) |
| Charging temperature | 5°C to 35 °C (41°F to 95°F) |
| Relative humidity (operating) | 5% to 95% non-condensing, |
| Electrostatic Discharge (ESD) | +/-15 kV air discharge, +/-8 kV direct discharge |
| Sealant rating | IP67 |
| Screen Specifications | |

| Parameter | Specification |
|------------------------|---|
| Touch screen | <ul style="list-style-type: none"> • 480 x 640 pixels • 8.9 cm (3.5 in) Transmissive VGA • 65,536 (16-bit RGB) colors • Hardened Corning® Gorilla® Glass display • LED backlight • Ambient light sensor |
| Keypad Options | |
| Keypad Options (CN75) | <ul style="list-style-type: none"> • Numeric • Qwerty |
| Keypad Options (CN75e) | <ul style="list-style-type: none"> • Large Numeric • Qwerty Keypad |

CN75/CN75e Non-Incendive (NI)

| Parameter | Specification |
|--|---|
| Physical Dimensions (includes Battery but excludes I/O cover) | |
| Length (CN75 NI) | 16.9 cm (6.65 in) |
| Length (CN75e NI) | 19.5 cm (7.66 in) |
| Width | 8.0 cm (3.16 in) |
| Depth | 3.4 cm (1.34 in) |
| Weight (CN75 NI) | 450 g (15.9 oz) |
| Weight (CN75e NI) | 491 g (17.3 oz) |
| Tumble and Drop | |
| Tumble Specifications | 2,000 (1 m) tumbles per IEC 60068-2-32 specification |
| Drop Specifications | 2.4 m (8 ft) to concrete per MIL-STD 810G; 1.8 m (6 ft) to concrete across operating temperature range per MIL-STD 810G |
| Power and Electrical | |
| Rechargeable Li-ion battery pack | Model 1000AB02 (PN 318-043-033) |
| Battery configuration | 1S2P (1 cell in series and 2 cells in parallel) |
| Nominal output and capacity | 3.7 VDC, 4000 mAh (14.8 Wh) |
| Environment | |
| Operating temperature* | -20°C to 50°C (-4°F to 122°F) |
| Storage temperature | -20°C to 60°C (-4°F to 140°F) |
| Charging temperature | 5°C to 35 °C (41°F to 95°F) |
| Relative humidity (operating) | 5% to 95% non-condensing |

| Parameter | Specification |
|---|---|
| Electrostatic Discharge (ESD) | +/-15 kV air discharge, +/-8 kV direct discharge |
| Sealant rating | IP67 |
| The CN75 and CN75e mobile computers with non-incendive (NI) certification comply with the following specifications for North America and Canada regions only. | |
| Location | Suitable for use in Division 2 locations |
| Safety | cULus Listing - ISA/ANSI 12.12.01 |
| Gases | Class I - Groups A, B, C, D |
| Dusts | Class II - Groups F, G |
| Fibers and flyings | Class III |
| * Max. Ambient | T6 rating with a maximum temperature of 50 °C (122 °F) |
| Screen Specifications | |
| Touch screen | <ul style="list-style-type: none"> • 480 x 640 pixels • 8.9 cm (3.5 in) Transmissive VGA • 65,536 (16-bit RGB) colors • Hardened Corning® Gorilla® Glass display • LED backlight • Ambient light sensor |
| Keypad Options | |
| Keypad Options (CN75 NI) | <ul style="list-style-type: none"> • Numeric • Qwerty |
| Keypad Options (CN75e NI) | <ul style="list-style-type: none"> • Large Numeric • Qwerty Keypad |

CK75

| Parameter | Specification |
|---|---|
| Physical Dimensions (Includes Battery) | |
| Length | 23.7 cm (9.33 in) |
| Width | 8.0 cm (3.16 in) |
| Depth | 5.0 cm (1.98 in) |
| Weight | 584 g (20.6 oz) |
| Tumble and Drop | |
| Tumble Specifications | 2,000 (1 m) tumbles per IEC 60068-2-32 specification |
| Drop Specifications | 2.4 m (8 ft) to concrete per MIL-STD 810G; 1.8 m (6 ft) to concrete across operating temperature range per MIL-STD 810G |

| Parameter | Specification |
|---|---|
| Power and Electrical | |
| Rechargeable Li-ion battery pack (Standard Model) | Model 1001AB01 (PN 318-046-031) |
| Rechargeable Li-ion battery pack (Cold Storage Model) | Model 1001AB01 (PN 318-046-032) |
| Nominal output and capacity | 3.7 VDC, 5200 mAh (19.2 Wh) |
| Environment | |
| Standard Model | |
| Operating temperature | -20°C to 60°C (-4°F to 140°F) |
| Storage temperature | -20°C to 60°C (-4°F to 140°F) |
| Charging temperature | 5°C to 35 °C (41°F to 95°F) |
| Sealant rating | IP67 |
| Cold Storage Model | |
| Operating temperature | -30°C to 60°C (-22°F to 140°F) |
| Storage temperature | -30°C to 60°C (-22°F to 140°F) |
| Charging temperature | 5°C to 35 °C (41°F to 95°F) |
| Sealant rating | IP65 |
| Relative humidity (operating) | 5% to 95% non-condensing |
| Electrostatic Discharge (ESD) | +/-15 kV air discharge, +/-8 kV direct discharge |
| Screen Specifications | |
| Touch screen | <ul style="list-style-type: none"> • 480 x 640 pixels • 8.9 cm (3.5 in) Transmissive VGA • 65,536 (16-bit RGB) colors • Hardened Corning® Gorilla® Glass display • LED backlight • Ambient light sensor |
| Keypad Options | |
| Keypad Options | <ul style="list-style-type: none"> • Numeric with Function Keys • Alphanumeric |

Back Accessory Interface Pin-outs

The back accessory interface provides power for peripheral devices out the back of the 75 Series computers.

| Pin | Pin Name | I/O | Description |
|-----|----------|--------|-----------------------------|
| 1 | OTB_PWR | Output | Power supply for peripheral |

| Pin | Pin Name | I/O | Description |
|-----|-----------------|--------|---------------------|
| 2 | GND | | |
| 3 | OTB_RX | Input | DTE Data Receive |
| 4 | OTB_TX | Output | DTE Data Transmit |
| 5 | OTB_I/O_Voltage | Input | I/O Voltage Level |
| 6 | OTB_ID | BiDir | One Wire Bus for ID |
| 7 | OTB_RTS | Output | DTE Ready to Send |
| 8 | OTB_CTS | Input | DTE Clear to Send |

Imager Specifications

The 75 Series offers these high-performance imager options.

| Parameter | Specification |
|------------------------|--|
| Imager | |
| EA30 (CN75/CN75e only) | EA30 High-Performance Motion-Tolerant 2D Imager with (up to 500 in/s) white LED illumination, red laser aimer and framer optimized for all lighting conditions. Capable of scanning all common 1D and 2D bar codes, including 1D as small as 4 mils and 2D as small as 6.6 mils. |
| EX25 (CK75 only) | Near/Far High-Performance 2D Imager Capable of scanning 1D and 2D bar codes from 15.2 cm to 16.2 m (6 in to 50 ft). |
| N5603ER (CK75 only) | High-Performance 2D Imager: Capable of scanning all common 1D and 2D bar codes, including 1D as small as 5 mil and standard UPC codes up to 53 cm (21 in). |

Bar Code Symbolologies

| Supported Bar Code Symbolologies | | |
|----------------------------------|----------------------|-----------------|
| AustraliaPost | DataMatrix | Maxicode |
| Aztec | Dutch Post | Micro PDF417 |
| BPO | EAN/UPC | MSI |
| Canada Post | GS1 Composite | PDF417 |
| China Post | GS1 DataBar Expanded | Planet |
| Codabar | GS1 DataBar Limited | Plessey |
| Codablock A | HanXin | Postnet |
| Codablock F | Infomail | QR Code |
| Code 11 | Interleaved 2 of 5 | Standard 2 of 5 |
| Code 39 | Japan Post | Telepen |
| Code 93 | KoreanPost | TLC 39 |
| Code 128/GS1-128 | Matrix 2 of 5 | |

EA30 Extended Reading Range

These typical reading distances are measured in an office environment (250 lux) for the EA30 standard model with Extended Reading Range activated. Extended Reading Range is enabled by default.

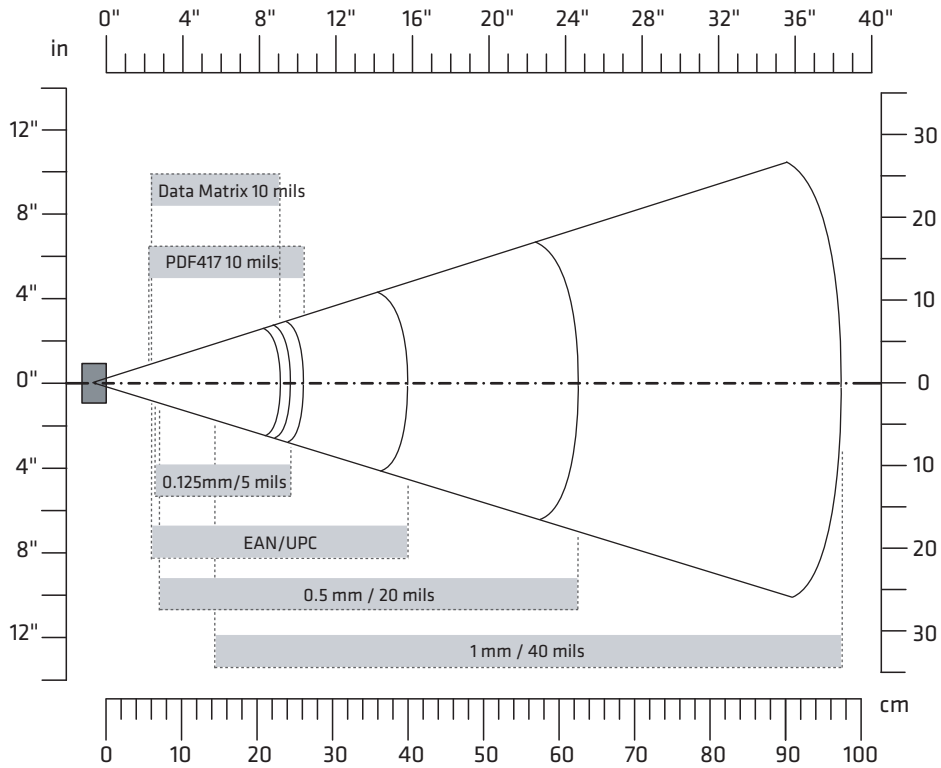

| Symbology | Density | Distance | |
|--------------|-----------------|------------------|-------------------|
| | | Minimum | Maximum |
| Code 39 | 0.125 mm/5 mils | 6.50 cm/2.56 in | 24.50 cm/9.65 in |
| | 0.50 mm/20 mils | 7 cm/ 2.76 in | 62.50 cm/24.61 in |
| | 1 mm/40 mils | 14.50 cm/5.71 in | 97.50 cm/38.39 in |
| EAN/UPC 100% | 0.33 mm/13 mils | 6 cm/2.36 in | 40 cm/15.75 in |

EA30 Minimum Reading Distances

Minimum distances are measured in the dark (0 lux).

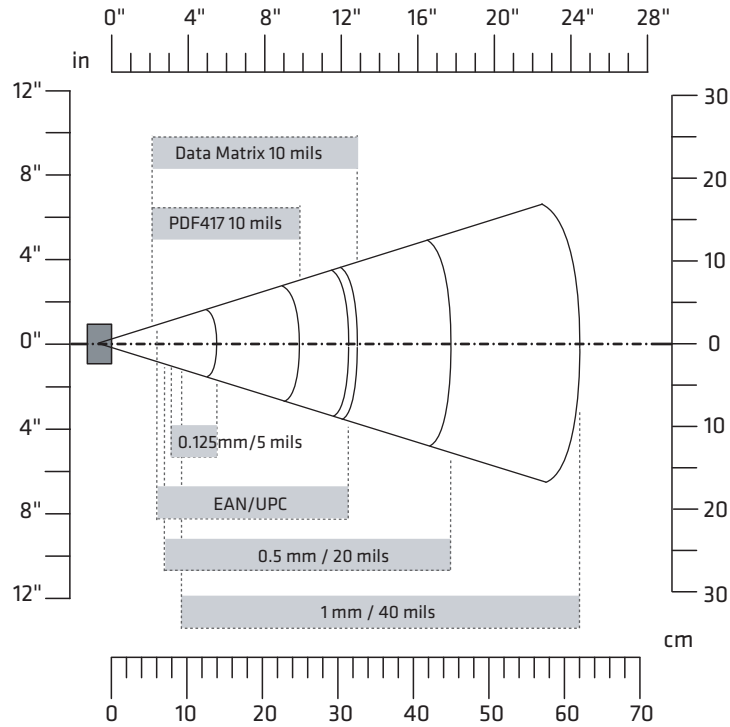

| Symbology | Density | Distance | |
|--------------|-------------------|------------------|-------------------|
| | | Minimum | Maximum |
| Code 39 | 0.10 mm (4 mils) | 9.5 cm (3.74 in) | 10.5 cm (4.13 in) |
| | 0.13 mm (5 mils) | 8 cm (3.15 in) | 14 cm (5.51 in) |
| | 0.50 mm (20 mils) | 7 cm (2.76 in) | 45 cm (17.72 in) |
| | 1 mm (40 mils) | 9.5 cm (3.74 in) | 62 cm (24.41 in) |
| EAN/UPC 100% | 0.33 mm/13 mils | 6 cm/2.36 in | 31.5 cm (12.4 in) |
| Data Matrix | 0.18 mm (7 mils) | 8 cm (3.15 in) | 15.5 cm (6.1 in) |
| | 0.25 mm (10 mils) | 6.5 cm (2.56 in) | 21.5 cm (8.46 in) |
| | 0.38 mm (15 mils) | 5.5 cm (2.17 in) | 31.5 cm (12.4 in) |
| PDF417 | 0.25 mm (10 mils) | 5.5 cm (2.17 in) | 25 cm (9.84 in) |
| | 0.38 mm (15 mils) | 7 cm (2.76 in) | 34 cm (13.39 in) |

EX25 Minimum Reading Distance

Minimum reading distances are measured in the dark (0 lux). The following graphic does not include the 0.24 cm (0.09 in) setback for the CK75.

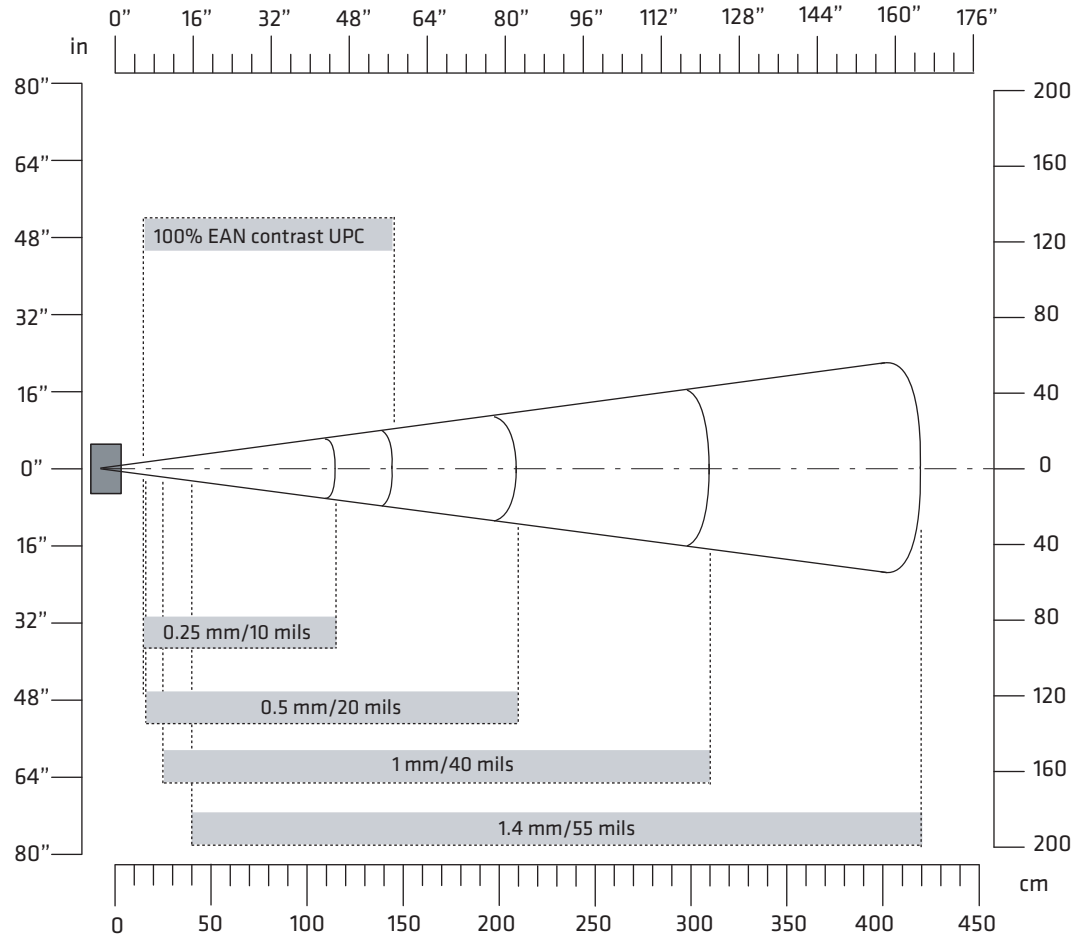

| EX25 Minimum Reading Distances with 0.24 cm (0.09 in) Setback | | | |
|---|-------------------|------------------|--------------------|
| Symbology | Density | Distance | |
| | | Minimum | Maximum |
| Code 39 | 0.08 mm (3 mils) | 15 cm (5.91 in) | 35 cm (13.78 in) |
| | 0.1 mm (2.8 mils) | 15 cm (5.91 in) | 45 cm (17.72 in) |
| | 0.25 mm (10 mils) | 15 cm (5.91 in) | 115 cm (45.28 in) |
| | 0.5 mm (20 mils) | 16 cm (6.30 in) | 210 cm (82.68 in) |
| | 1 mm (40 mils) | 25 cm (9.84 in) | 310 cm (122.05 in) |
| | 1.3 mm (51 mils) | 40 cm (15.75 in) | 310 cm (122.05 in) |
| EAN 100% | 0.33 mm (13 mils) | 15 cm (5.91 in) | 145 cm (57.09 in) |

EX25 Typical Reading Distance (1D)

Typical reading distances are measured in an office environment (200 lux). The following graphics do not include the 0.24 cm (0.09 in) setback for the CK75.

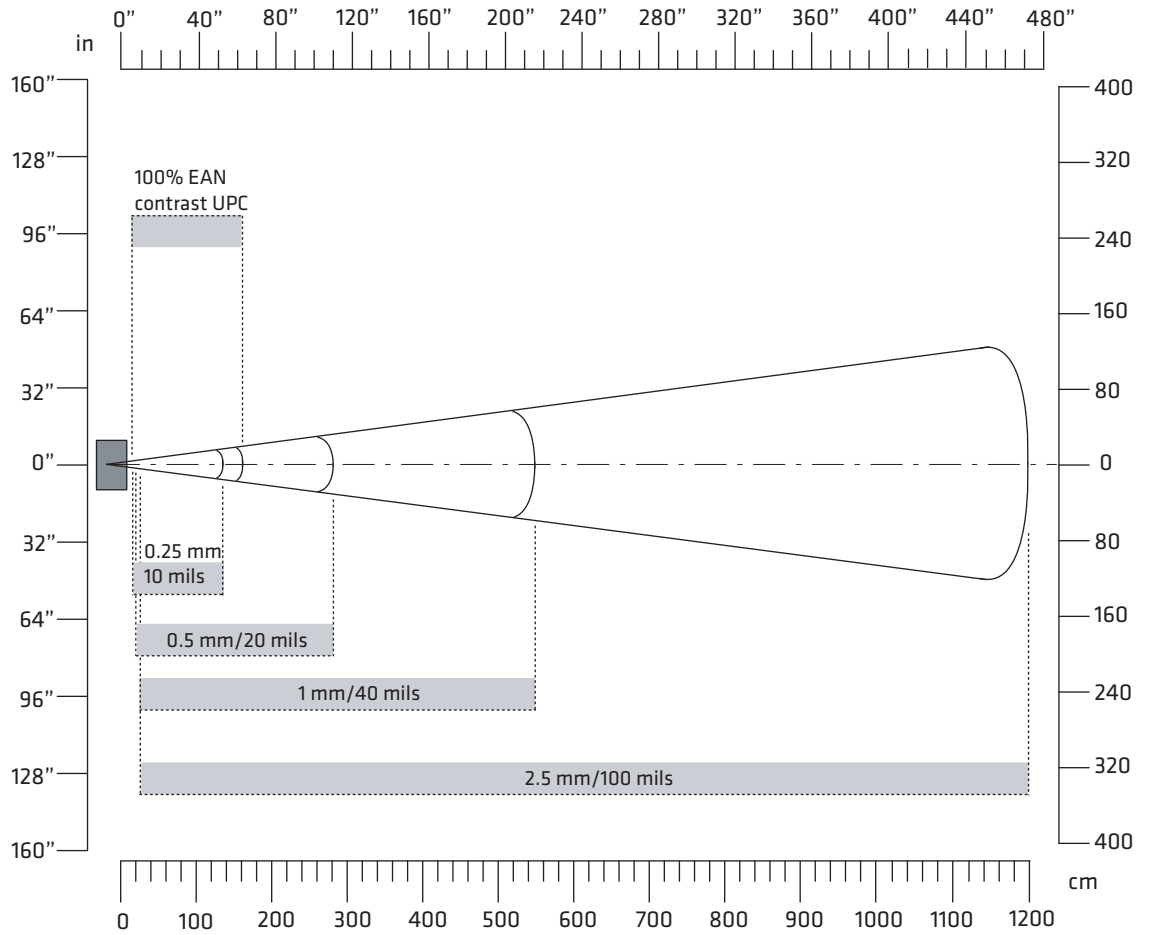

| EX25 1D Symbologies Typical Reading Distances with 0.24 cm (0.09 in) Setback | | | |
|--|-------------------|------------------|---------------------|
| Symbology | Density | Distance | |
| | | Minimum | Maximum |
| Code 39 | 0.25 mm (10 mils) | 15 cm (5.91 in) | 135 cm (53.15 in) |
| | 0.5 mm (20 mils) | 16 cm (6.30 in) | 280 cm (110.24 in) |
| | 1 mm (40 mils) | 25 cm (9.84 in) | 550 cm (216.54 in) |
| | 1.4 mm (55 mils) | 40 cm (15.75 in) | 720 cm (283.46 in) |
| | 2.5 mm (100 mils) | ** | 1200 cm (472.44 in) |
| Code 128 retro-reflective | 2.5 mm (100 mils) | ** | 1300 cm (511.81 in) |
| EAN 100% | 0.33 mm (13 mils) | 15 cm (5.91 in) | 160 cm (62.99 in) |

** Minimum distance depends on bar code width and scan angle.

EX25 Typical Reading Distance (2D)

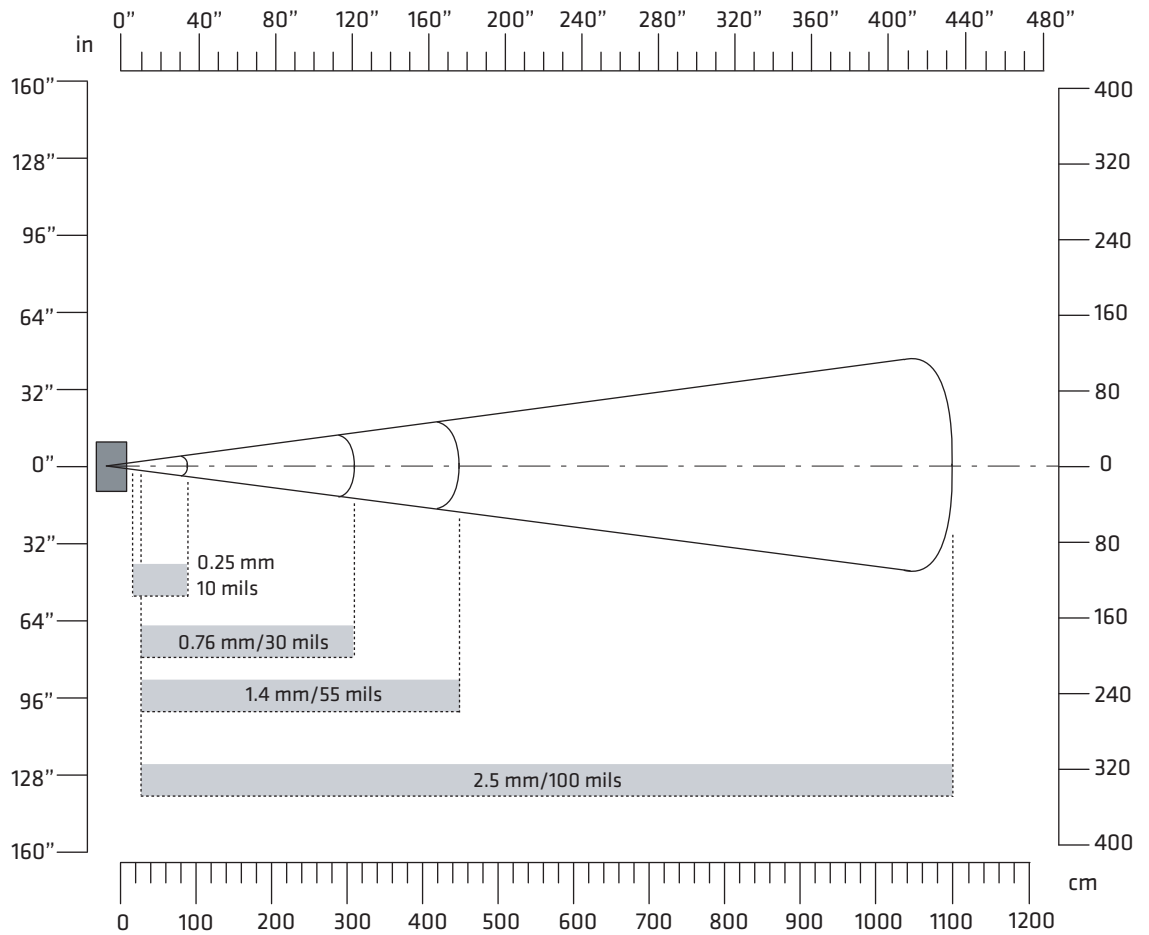

| EX25 2D Symbologies Typical Reading Distances with 0.24 cm (0.09 in) Setback | | | |
|---|-------------------|-----------------|---------------------|
| Symbology | Density | Distance | |
| | | Minimum | Maximum |
| DataMatrix | 0.25 mm (10 mils) | 15 cm (5.91 in) | 90 cm (35.43 in) |
| | 0.76 mm (30 mils) | 25 cm (9.84 in) | 310 cm (122.05 in) |
| | 1.4 mm (55 mils) | ** | 450 cm (177.17 in) |
| | 2.5 mm (100 mils) | ** | 1100 cm (433.07 in) |
| | 7.5 mm (300 mils) | 20 cm (7.87 in) | 1524 cm (600 in) |
| ** Minimum distance depends on bar code width and scan angle. | | | |

N5603 Extended Range Reading Distances

| Red Illumination Monochrome and Monocolor Sensors - Guaranteed Specifications | | | |
|--|----------------------|---------------------|-----------------|
| Minimum reading distances are measured in the dark (0 lux). | | | |
| Symbology | Near Distance | Far Distance | Delta |
| 5 mil Code39/128 | 14.7 cm/5.8 in | 22.4 cm/8.8 in | 7.6 cm/3.0 in |
| 7.5 mil Code 39/128 | 11.2 cm/4.4 in | 33.2 cm/13 in | 21.8 cm/8.6 in |
| 10 mil Code 39/128 | 8.1 cm/3.2 in | 40.9 cm/16.1 in | 32.8 cm/12.9 in |
| 15 mil Code 39/128 | 5.1 cm/2.0 in | 48.3 cm/19.0 in | 43.2 cm/17.0 in |
| 20 mil Code 39/128 | 7.9 cm/3.1 in | 57.9 cm/22.8 in | 50 cm/16.2 in |
| 100% UPC | 7.1 cm/2.8 in | 48.3 cm/19.0 in | 41.2 cm/16.2 in |
| 5 mil PDF417 | 15.5 cm/6.1 in | 18.8 cm/7.4 in | 3.3 cm/1.3 in |
| 6.7 mil PDF417 | 11.9 cm/4.7 in | 24.9 cm/9.8 in | 13.0 cm/5.1 in |
| 10 mil PDF417 | 6.1 cm/2.4 in | 37.8 cm/14.9 in | 31.8 cm/12.5 in |
| 10 mil DataMatrix/ Aztec | 13.5 cm/5.3 in | 25.4 cm/10.0 in | 11.9 cm/4.7 in |
| 20 mil DataMatrix | 10.2 cm/4.0 in | 40.6 cm/16.0 in | 30.5 cm/12.0 in |
| 10 mil QR Code | 10.9 cm/4.3 in | 26.4 cm/10.4 in | 15.5 cm/6.1 in |
| 20 mil QR Code | 5.3 cm/2.1 in | 45.0 cm/17.7 in | 39.6 cm/15.6 in |
| 32 mil Maxicode | 10.7 cm/4.2 in | 45.0 cm/17.7 in | 34.3 cm/13.5 in |

| White Illumination Monocolor Sensor Only - Guaranteed Specifications | | | |
|---|----------------------|---------------------|-----------------|
| Minimum reading distances are measured at 535 lux. | | | |
| Symbology | Near Distance | Far Distance | Delta |
| 5 mil Code39/128 | 14.7 cm/5.8 in | 21.6 cm/8.5 in | 6.9 cm/2.7 in |
| 7.5 mil Code 39/128 | 11.2 cm/4.4 in | 31.0 cm/12.2 in | 19.8 cm/7.8 in |
| 10 mil Code 39/128 | 8.1 cm/3.2 in | 38.9 cm/15.3 in | 30.7 cm/12.1 in |
| 15 mil Code 39/128 | 5.1 cm/2.0 in | 46.5 cm/18.3 in | 41.4 cm/16.3 in |
| 20 mil Code 39/128 | 7.9 cm/3.1 in | 53.3 cm/21.0 in | 45.5 cm/17.9 in |
| 100% UPC | 7.1 cm/2.8 in | 46.5 cm/18.3 in | 39.4 cm/15.5 in |
| 5 mil PDF417 | 15.5 cm/6.1 in | 18.3 cm/7.2 in | 2.8 cm/1.1 in |
| 6.7 mil PDF417 | 11.9 cm/4.7 in | 24.1 cm/9.5 in | 12.2 cm/4.8 in |
| 10 mil PDF417 | 6.1 cm/2.4 in | 36.8 cm/14.5 in | 30.7 cm/12.1 in |
| 10 mil DataMatrix/ Aztec | 13.5 cm/5.3 in | 24.6 cm/9.7 in | 11.2 cm/4.4 in |
| 20 mil DataMatrix | 10.2 cm/4.0 in | 39.4 cm/15.5 in | 29.2 cm/11.5 in |
| 10 mil QR Code | 10.9 cm/4.3 in | 24.6 cm/9.7 in | 13.7 cm/5.4 in |
| 20 mil QR Code | 5.3 cm/2.1 in | 40.6 cm/16.0 in | 37.8 cm/14.9 in |
| 32 mil Maxicode | 10.7 cm/4.2 in | 43.7 cm/17.2 in | 33.0 cm/13.0 in |

Red Illumination Monochrome and Monocolor Sensors - Typical Specifications

Minimum reading distances are measured at 535 lux.

| Symbology | Near Distance | Far Distance | Delta |
|--------------------|----------------------|---------------------|-----------------|
| 10 mil Code 39/128 | 6.1 cm/2.4 in | 44.2 cm/17.4 in | 38.1 cm/15.0 in |
| 15 mil Code 39/128 | 3.8 cm/1.5 in | 54.9 cm/21.6 in | 51.1 cm/20.1 in |
| 100% UPC | 6.1cm/2.4 in | 53.3 cm/21.0 in | 47.2 cm/18.6 in |
| 10 mil PDF417 | 5.6 cm/2.2 in | 39.6 cm/15.6 in | 34.0 cm/13.4 in |
| 32 mil Maxicode | 7.9 cm/3.1 in | 52.8 cm/20.8 in | 44.9 cm/17.7 in |

White Illumination Monocolor Sensor Only- Typical Specifications

Minimum reading distances are measured at 535 lux.

| Symbology | Near Distance | Far Distance | Delta |
|--------------------|----------------------|---------------------|-----------------|
| 10 mil Code 39/128 | 6.1 cm/2.4 in | 42.7 cm/16.8 in | 36.6 cm/14.4 in |
| 15 mil Code 39/128 | 3.8 cm/1.5 in | 54.9 cm/21.6 in | 51.1 cm/20.1 in |
| 100% UPC | 6.1cm/2.4 in | 53.3 cm/21.0 in | 47.2 cm/18.6 in |
| 10 mil PDF417 | 5.6 cm/2.2 in | 39.6 cm/15.6 in | 34.0 cm/13.4 in |
| 32 mil Maxicode | 7.9 cm/3.1 in | 52.8 cm/20.8 in | 44.9 cm/17.7 in |

Field of View/Resolution

| Focus | Extended Range (ER) |
|----------------------------------|----------------------------|
| Horizontal Field Angle (degrees) | ±15.8 |
| Vertical Field Angle (degrees) | ±12.2 |

Honeywell
9680 Old Bailes Road
Fort Mill, SC 29707

www.honeywellaidc.com